



NEVER STOP
dreaming

SPRING / SUMMER
2021

LEGAMI
MILANO



Index

1	HOME SWEET HOME COLLECTION	PAGE 3		6	STATIONERY COLLECTION	PAGE 160
	Kitchen	page 4			Pens	page 161
	Lighting	page 16			Pencils	page 168
	Easy living	page 21			Erasers	page 172
	Cool tools	page 23			Pencil sharpeners	page 175
	Photo lovers	page 24			Pencil cases	page 177
2	TRAVEL COLLECTION	PAGE 26			Desk accessories	page 178
	Travel organiser	page 27			Highlighters	page 182
	Passport holder	page 28			Tapes	page 183
	Badge holder	page 29			Correction tapes	page 184
	Card holder	page 30			Glue tapes	page 185
	Luggage tag	page 30			Rulers	page 185
	Luggage strap	page 31			Paper world	page 186
	Hands free strap	page 31			Bookmarks	page 190
	Sleep masks	page 32			Are you serious? Collection	page 195
	Travel pillows	page 33		7	NOTEBOOK COLLECTION	PAGE 205
	Travel organiser set	page 34			Quaderno	page 206
	Foldable travel bag	page 34			Spiral notebooks	page 209
	Travel toiletry bag	page 35			Photo notebooks	page 212
	Traveller set	page 35			My notebook	page 216
	Foldable backpack	page 36		8	LET'S PARTY TOGETHER	PAGE 222
	Travel bags	page 36			Gift bags	page 223
	Travel scales	page 37			Wrapping paper	page 230
	Mini travel iron	page 38			Greetings cards	page 232
	Lint-removing sticky roller	page 38			Birthday calendar	page 246
	Tsa luggage padlock	page 39			Balloon modelling kit	page 246
	Travel alarm clock	page 39			Party crowns	page 247
	Worldwide travel adapter	page 39			Party poppers	page 248
3	BAGS & CO. COLLECTION	PAGE 40			Party candles	page 249
	What a wallet!	page 41		9	PRE-ASSORTED DISPLAYS	PAGE 252
	Hot & cold	page 42		10	DISPLAYS ON DEMAND	PAGE 252
	What a mask!	page 44		11	PRE-ASSORTED PACK	PAGE 257
	Coin purse & zipper pouch	page 46				
	Fiesta & siesta	page 48				
	Umbrellas	page 48				
	Bags	page 50				
4	MINI COLLECTION	PAGE 52				
	Nice to meet you	page 53				
	Keep in contact	page 54				
	See you soon	page 54				
	Secrets box	page 55				
	Key rings & accessories	page 57				
5	LIFESTYLE COLLECTION	PAGE 61				
	Mugs	page 62				
	Magnets	page 70				
	Beauty collection	page 74				
	SOS collection	page 86				
	Smoking area	page 99				
	Hi-Tech collection	page 101				
	Bikeaholic collection	page 131				
	L.O.L. collection	page 138				
	Vintage memories collection	page 142				
	Wonderland collection	page 156				

Home sweet home

COLLECTION



KITCHEN

BOTTLE COOLER

L 36 x H 18 x W 1 cm (open)

BOTTLE COOLER

- Adjustable velcro closure: it fits both wine and champagne bottles
- Contains a refrigerating gel: ready to use after just 2 hours in the freezer
- Material: polyester, PVC, refrigerating gel

FASCIA REFRIGERANTE PER BOTTIGLIA

- Chiusura regolabile in velcro: si adatta sia alle bottiglie di vino che a quelle di champagne
- Contiene un gel refrigerante: pronta all'uso dopo solo 2 ore di freezer
- Materiale: poliester, PVC, gel refrigerante

BANDE RÉFRIGÉRANTE POUR BOUTEILLE

- Fermeture réglable en velcro : elle s'adapte aussi bien aux bouteilles de vin qu'aux bouteilles de champagne
- Elle contient un gel réfrigérant : prête à l'emploi après seulement 2 heures au congélateur
- Matériau : polyester, PVC, gel réfrigérant

BANDA REFRIGERANTE PARA BOTELLA

- Cierre regulable con velcro: se adapta tanto a las botellas de vino como a las de champán
- Contiene un gel refrigerante: lista para el uso después de solo 2 horas de congelador
- Material: poliéster, PVC, gel refrigerante

KÜHLMANSCHETTE FÜR FLASCHE

- Einstellbarer Klettverschluss: Passt sich sowohl an Wein- wie auch an Champagnerflaschen an
- Enthält ein Kühlgel: Nach nur 2 Stunden im Gefrierschrank verwendungsbereit
- Material: Polyester, PVC, Kühlgel



PACKAGING

cardboard box
L 15 x H 22 x W 2.5 cm
SOLD x 4



WINE LOVER
ACW0001



8 059174 839826



CHEETAH
ACW0002



8 059174 839833

REUSABLE ICE CUBES

REUSABLE ICE CUBES

- The packaging contains 16 pieces
- Pre-filled with water
- Material: plastic, water

CUBETTI DI GHIACCIO RIUTILIZZABILI

- La confezione contiene 16 forme
- Pre-riempiti con acqua
- Materiale: plastica, acqua

GLAÇONS RÉUTILISABLES

- L'emballage contient 16 formes
- Pré-remplis avec de l'eau
- Matériau : plastique, eau

CUBITOS DE HIELO REUTILIZABLES

- El envase contiene 16 formas
- Rellenados previamente con agua
- Material: plástico, agua

WIEDERVERWENDBARE EISWÜRFEL

- Die Verpackung enthält 16 Formen
- Mit Wasser vorgefüllt
- Material: Kunststoff, Wasser



CLUB TROPICANA



SHINE BRIGHT

PACKAGING

plastic shaker
Ø 7.5 cm, H 16.5 cm
SOLD X 4

ICS0001



PACKAGING

plastic shaker
Ø 7.5 cm, H 16.5 cm
SOLD X 4

ICS0002



STAINLESS STEEL STRAWS

STAINLESS STEEL STRAWS

- Brush included for easy hand washing
- Material: stainless steel

CANNUCCE IN ACCIAIO INOX

- Scovolino incluso per una facile pulizia a mano
- Materiale: acciaio inox

PAILLES EN ACIER INOX

- Goupillon inclus, pour un nettoyage facile à la main
- Matériau : acier inox

PAJITAS DE ACERO INOXIDABLE

- Cepillo incluido para una fácil limpieza a mano
- Material: acero inoxidable

STROHHALMEN AUS EDELSTAHL

- Inklusive kleiner Bürste zum einfachen Reinigen von Hand
- Material: Edelstahl



STANDARD SIZE

Ø 0.6 cm, H 21.5 cm



PACKAGING

window box
L 8 x H 25 x W 1.5 cm
SOLD X 6

STRW0001



COCKTAIL SIZE

Ø 0.6 cm, H 13.5 cm



PACKAGING

window box
L 6 x H 16 x W 1.5 cm
SOLD X 6

STRW0002



FIESTA!

L MAX 1.8 x H MAX 2.9 x W 1.5 cm

SET OF 6 DRINK MARKERS

- Reusable and durable
- Material: silicone

SET DI 6 SEGNABICCHIERI

- Riutilizzabili e durevoli
- Materiale: silicone

SET DE 6 MARQUE-VERRES

- Réutilisables et durables
- Matériau : silicone

SET DE 6 MARCADORES DE VASOS

- Reutilizables y duraderos
- Material: silicona

SET AUS 6 GLASMARKIERER

- Wiederverwendbar und langlebig
- Material: Silikon



PACKAGING

cardboard box
L 9 x H 9.5 x W 1.6 cm



DISPLAY

material: cardboard
L 10 x H 19.7 x W 14 cm

8 PCS

DRMAKIT1



MEOW

L MAX 2.2 x H MAX 2.7 x W 0.9 cm

SET OF 6 DRINK MARKERS

- Reusable and durable
- Material: silicone

SET DI 6 SEGNABICCHIERI

- Riutilizzabili e durevoli
- Materiale: silicone

SET DE 6 MARQUE-VERRES

- Réutilisables et durables
- Matériau : silicone

SET DE 6 MARCADORES DE VASOS

- Reutilizables y duraderos
- Material: silicona

SET AUS 6 GLASMARKIERER

- Wiederverwendbar und langlebig
- Material: Silikon



PACKAGING

cardboard box
L 9 x H 9.5 x W 1.6 cm



DISPLAY

material: cardboard
L 10 x H 19.7 x W 14 cm

8 PCS

DRMAKIT2



GENTLEMEN

L MAX 4 x H MAX 3,4 x W 0,1 cm

SET OF 6 DRINK MARKERS

- Reusable and durable
- Material: silicone

SET DI 6 SEGNABICCHIERI

- Riutilizzabili e durevoli
- Materiale: silicone

SET DE 6 MARQUE-VERRES

- Réutilisables et durables
- Matériau : silicone

SET DE 6 MARCADORES DE VASOS

- Reutilizables y duraderos
- Material: silicona

SET AUS 6 GLASMARKIERER

- Wiederverwendbar und langlebig
- Material: Silikon

PACKAGING

cardboard box
L 9 x H 9,5 x W 1,6 cm



DISPLAY

material: cardboard
L 10 x H 19,7 x W 14 cm

8 PCS

DRMAKIT3



Stick and peel off



NO RAINBOW NO PARTY!

L 6,5 x H 7 x W 2,8 cm

STOPPER AND DRINK-MARKER SET

- 6 drink markers + 1 bottle stopper
- Material: silicone

SET TAPPO E SEGNABICCHIERI

- 6 segnabicchieri + 1 tappo per bottiglia
- Materiale: silicone

SET DE BOUCHON ET DE MARQUE-VERRES

- 6 marque-verres + 1 bouchon pour bouteille
- Matériau : silicone

SET DE TAPÓN Y MARCADORES DE VASOS

- 6 marcadores de vasos + 1 tapón para botella
- Material: silicona

SET AUS VERSCHLUSS UND GLASMARKIERERN

- 6 Glasmarkierern + 1 Flaschenverschluss
- Material: Silikon

PACKAGING

PVC box w/hook
L 8,8 x H 14,8 x W 3,2 cm



DISPLAY

material: cardboard
L 9,5 x H 14,8 x W 19,5 cm

6 PCS

DRMAKIT4



MEOW

L MAX 3.4 x H MAX 9 x W 0.4 cm

SET OF 6 APERITIF FORKS

- Reusable and durable
- Ideal for small pieces of fruit, olives, snacks and finger food
- Material: stainless steel and silicone

SET DI 6 FORCHETTINE PER APERITIVO

- Riutilizzabili e durevoli
- Ideali per piccoli pezzi di frutta, olive, snack e finger food
- Materiale: acciaio inox e silicone

SET DE 6 PETITES FOURCHETTES POUR L'APÉRITIF

- Réutilisables et durables
- Idéales pour les petits morceaux de fruits, les olives, les petits-fours et les amuse-gueules
- Matériau : acier inox et silicone

SET DE 6 TENEDORES PEQUEÑOS DE APERITIVO

- Reutilizables y duraderos
- Ideales para pequeños trozos de fruta, olivas, snacks y comida para picar
- Material: acero inoxidable y silicona

SET AUS 6 APERITIF-GÄBELCHEN

- Wiederverwendbar und langlebig
- Ideal für Fruchtstückchen, Oliven, Snacks und Fingerfood
- Material: Edelstahl und Silikon



PACKAGING

PVC box w/ hook
L 20 x H 11.5 x W 9 cm

SOLD X 6

PICK0001



ONE FOR ALL

L 1.6 x H 9.5 x W 1.6 cm

SET OF 6 PARTY PICKS

- Reusable and durable
- Ideal for small pieces of fruit, olives, snacks and finger food
- Material: stainless steel and silicone

SET DI 6 BASTONCINI PER APERITIVO

- Riutilizzabili e durevoli
- Ideali per piccoli pezzi di frutta, olive, snack e finger food
- Materiale: acciaio inox e silicone

SET DE 6 PICS POUR L'APÉRITIF

- Réutilisables et durables
- Idéals pour les petits morceaux de fruits, les olives, les petits-fours et les amuse-gueules
- Matériau : acier inox et silicone

SET DE 6 PALILLOS PARA APERITIVO

- Reutilizables y duraderos
- Ideales para pequeños trozos de fruta, olivas, snacks y comida para picar
- Material: acero inoxidable y silicona

SET AUS 6 APERITIF-STICKS

- Wiederverwendbar und langlebig
- Ideal für Fruchtstückchen, Oliven, Snacks und Fingerfood
- Material: Edelstahl und Silikon



PACKAGING

PVC box w/ hook
L 9.5 x H 21 x W 1.8 cm

SOLD X 6

PICK0002



MICROWAVE CLEANER

Ø 14 cm, H 12 cm

MICROWAVE CLEANER

- Dissolves dirt deposits in just over 5 minutes
- Material: plastic

PULISCI MICROONDE

- Scioglie le incrostazioni di sporco in poco più di 5 minuti
- Materiale: plastica

NETTOYANT POUR MICRO-ONDES

- Il fait fondre les saletés incrustées en à peine plus de 5 minutes
- Matériau : plastique

LIMPIADOR DE MICROONDAS

- ¡Disuelve las incrustaciones de suciedad en poco más de 5 minutos
- Material: plástico

MIKROWELLENREINIGER

- Löst verkrusteten Schmutz in knapp mehr als 5 Minuten
- Material: Kunststoff

PACKAGING

cardboard box
L 14 x H 12.5 x W 14 cm

SOLD X 4

VOC0001



8 059174 834296



**ADD VINEGAR
AND WATER**

Double-walled base specifically designed to keep the outer layer cool

RECIPE BOOK

L 22 x H 28 x W 13 cm

RECIPE COLLECTION FOLDER

- Ideal for holding your favourite recipes
- 6 cardboard dividers
- 50 browsable transparent pockets
- Foldable and storable
- Material: paper, plastic. Rigid cardboard support

RACCOGLITORE PORTA-RICETTE

- Ideale per custodire le tue ricette preferite
- 6 separatori in cartoncino
- 50 buste sfogliabili trasparenti
- Ripiegabile e riponibile
- Materiale: carta, plastica. Supporto in cartoncino rigido

CLASSEUR PORTE-RECETTES

- Idéal pour conserver vos recettes favorites
- 6 séparateurs en carton
- 50 enveloppes transparentes à feuilletter
- Pliable et facile à ranger
- Matériau : papier, plastique. Support en carton rigide

LIBRO DE RECETAS

- Ideal para guardar tus recetas preferidas
- 6 separadores de cartón
- 50 sobres hojeables transparentes
- Fácil de plegar y guardar
- Material: papel, plástico. Soporte de cartón rígido

ORDNER FÜR REZEPTE

- Ideal zum Aufbewahren Ihrer Lieblingsrezepte
- 6 Trennblätter aus Pappe
- 50 transparente Hüllen zum Umblättern
- Leicht zusammenzuklappen und aufzubewahren
- Material: Papier, Kunststoff. Basis aus stabilem Karton

PACKAGING

view top box
with cardboard base
L 23.5 x H 29.5 x W 4 cm

SOLD X 2

REC0002



8 052783 619018



138 stickers included



WINE SET

WINE SET

- Set of stainless steel accessories in a bottle-shaped case
- Small: corkscrew, ring drip stopper, pouring stopper
- Large: corkscrew, bottle opener, ring drip stopper, standard stopper, pouring stopper
- Material: stainless steel, plastic

SET DA VINO

- Set di accessori in acciaio inox in custodia a forma di bottiglia
- Small: cavatappi, anello salva-goccia, tappo versatore
- Large: cavatappi, levacapsule, anello salva-goccia, tappo standard, tappo versatore
- Materiale: acciaio inox, plastica

SET DE VIN

- Set d'accessoires en acier inox dans un étui en forme de bouteille
- Small: tire-bouchon, bague anti-goutte, bouchon verseur
- Large: tire-bouchon, décapsuleur, bague anti-goutte, bouchon standard, bouchon verseur
- Matériau : acier inox, plastique

SET DE VINO

- Set de accesorios en acero inoxidable en estuche con forma de botella
- Small: sacacorchos, anillo antigoteo, tapón decantador
- Large: sacacorchos, cortacápsulas, anillo antigoteo, tapón estándar, tapón decantador
- Material: acero inoxidable, plástico

WEIN-SET

- Zubehör-Set aus rostfreiem Stahl in einem flaschenförmigen Etui
- Small: Korkezieher, Tropfenauffangring, Gießverschluss
- Large: Korkezieher, Flaschenöffner, Tropfenauffangring, Standardverschluss, Gießverschluss
- Material: Edelstahl, Kunststoff

SMALL

3 accessories
Ø 6.5 cm,
H 23.5 cm



PACKAGING

cardboard box
L 7 x H 24 x W 7 cm
SOLD X 4

BTLO001



8 052783 618325



LARGE

5 accessories
Ø 7.5 cm,
H 32.5 cm



PACKAGING

cardboard box
L 8 x H 33 x W 8 cm
SOLD X 4

BTLO002



8 052783 618332



BOTTLE OPENER

Ø 2.4 cm , H 11.5 cm

BOTTLE OPENER

- Practical and functional
- 2 in 1 function: corkscrew and bottle opener
- Material: stainless steel, ABS

APRIBOTTIGLIE

- Pratico e funzionale
- Funzione 2 in 1: cavatappi e apribottiglie
- Materiale: acciaio inox, ABS

OUVRE-BOUTEILLE

- Pratique et fonctionnel
- Fonction 2 en 1 : tire-bouchon et ouvre-bouteille
- Matériau : acier inox, ABS

ABREBOTELLAS

- Práctico y funcional
- Función 2 en 1: sacacorchos y abrebotellas
- Material: acero inoxidable, ABS

FLASCHENÖFFNER

- Praktisch und funktional
- 2-in-1-Funktion: Korkezieher und Flaschenöffner
- Material: Edelstahl, ABS

PACKAGING

cardboard box
L 4.5 x H 14 x W 4 cm



DISPLAY

material: cardboard
L 15 x H 21 x W 13 cm
9 PCS

BOPK11



8 051128 754537



WINE VACUUM STOPPERS

Ø 3.3 cm, H 5.7 cm

SET OF 2 VACUUM STOPPERS FOR WINE

- Material: plastic, silicone seal

SET DI 2 TAPPI SOTTOVUOTO PER IL VINO

- Materiale: plastica, guarnizione in silicone

SET DE 2 BOUCHONS POMPE À VIN

- Matériau : plastique, joint en silicone

SET DE 2 TAPONES DE VACÍO PARA EL VINO

- Material: plástico, junta de sellado en silicona

SET AUS 2 VAKUUM-VERSCHLÜSSEN FÜR WEINFLASCHEN

- Material: Kunststoff, Dichtung aus Silikon

PACKAGINGcarded
L 10 x H 13 cm

Press the stopper repeatedly to extract the air

**DISPLAY**material: cardboard
L 22.5 x H 25.3 x
W 23.5 cm**12 PCS**

WINEKIT1



8 051128 751697



Numbers engraved on the stopper to remember the date the bottle was opened

**CHAMPAGNE STOPPER**

Ø 3.4 cm, H 6.3 cm

CHAMPAGNE STOPPER

- Material: plastic, metal, silicone seal

TAPPO CHAMPAGNE

- Materiale: plastica, metallo, guarnizione in silicone

BOUCHON À CHAMPAGNE

- Matériau : plastique, métal, joint en silicone

TAPÓN CHAMPÁN

- Material: plástico, metal, junta de sellado en silicona

CHAMPAGNERVERSCHLUSS

- Material: Kunststoff, Metall, Dichtung aus Silikon

PACKAGINGcardboard box
L 4.3 x H 6.7 x W 4.3 cm

Press the top repeatedly to pump air into the bottle until it is completely full

**DISPLAY**material: cardboard
L 14.5 x H 18.5 x
W 19.2 cm**12 PCS**

CHAKITI



8 051128 751987



Numbers engraved on the stopper to remember the date the bottle was opened

**BAG CLIPS****SET OF BAG CLIPS**

- Material: plastic

SET DE CLIPS DE FERMETURE POUR SACHETS

- Matériau : plastique

SET AUS VERSCHLUSS-CLIPS FÜR VERPACKUNGEN

- Material: Kunststoff

SET DI CLIP CHIUDI PACCO

- Materiale: plastica

SET DE PINZAS PARA CERRAR PAQUETES

- Material: plástico

SOLD X 6**MUSICAL NOTES**

L 5.5 x H 5 x W 1.5 cm



PACKAGING
OPP bag w/
cardboard
L 9.3 x H 21 cm

CLIP0001



8 058093 949906

PANDA

L 4 x H 3.3 x W 4 cm



PACKAGING
OPP bag w/
cardboard
L 9.3 x H 21 cm

CLIP0002



8 051122 265398

COOKIE

L 5 x H 5 x W 3.4 cm



PACKAGING
OPP bag w/
cardboard
L 12.5 x H 17.5 cm

CLIP0003



8 051122 265404

HEART

L 4.5 x H 4 x W 3 cm



PACKAGING
OPP bag w/
cardboard
L 10 x H 21 cm

CLIP0004



8 052783 618509

AVOCADO

L 4.3 x H 5.5 x W 3 cm



PACKAGING
OPP bag w/
cardboard
L 12.5 x H 17.5 cm

CLIP0005



8 052461 966083

NEW

COOLING BEER MUG

L 12 x H 15.5 cm, Ø 8.5 cm – 440 ml

COOLING BEER MUG

- Keeps beer (or any other drink) fresh for longer
- Double wall containing a fast-freezing amber liquid
- Ready to use after just 2 hours in the freezer
- Material: PS, EPS, cooling liquid

BOCCALE DI BIRRA REFRIGERANTE

- Mantiene la birra (o qualsiasi altra bevanda) fresca più a lungo
- Doppia parete contenente un liquido ambrato a rapido congelamento
- Pronto all'uso dopo solo 2 ore di freezer
- Materiale: PS, EPS, liquido refrigerante

CHOPE À BIÈRE RÉFRIGÉRANTE

- Elle maintient la bière (ou n'importe quelle autre boisson) fraîche plus longtemps
- Double paroi contenant un liquide ambré à congélation rapide
- Prête à l'emploi après seulement deux heures au congélateur
- Matériau : PS, EPS, liquide réfrigérant

JARRA DE CERVEZA REFRIGERANTE

- Mantiene la cerveza (o cualquier otra bebida) fresca durante más tiempo
- Doble pared que contiene un líquido ambarino de congelación rápida
- Listo para el uso después de tan solo 2 horas en la nevera
- Material: PS, EPS, líquido refrigerante

KÜHLENDER BIERKRUG

- Hält Bier (oder andere Getränke) länger kühl
- Die Doppelwand enthält eine bernsteinfarbene Flüssigkeit, die schnell kühlt
- Nach nur zwei Stunden im Gefrierschrank einsatzbereit
- Material: PS, EPS, Kühlmittel

PACKAGING

window box
L 11 x H 16.5 x W 11 cm

SOLD X 4

BMUG0001



8 059174 834814



SAUCE DISPENSER GUN

L 22 x H 16.5 x W 5.5 cm

SAUCE DISPENSER GUN

- Contains two reusable containers for sauces
- Material: ABS, PE

PISTOLA SPARA SALSE

- Contiene due contenitori per salse riutilizzabili
- Materiale: ABS, PE

PISTOLET DISTRIBUTEUR DE SAUCES

- Contient deux réservoirs à sauces réutilisables
- Matériau : ABS, PE

PISTOLA PARA SALSAS

- Contiene dos recipientes reutilizables para salsas
- Material: ABS, PE

SAUCENSPENDER IN PISTOLENFORM

- Enthält zwei wiederverwendbare Behälter für Saucen
- Material: ABS, PE



100 ml 100 ml

PACKAGING

cardboard box
L 23 x H 16.2 x W 5.7 cm

SOLD X 4

BCG0001



8 051739 307023



SHOT GLASSES

L 6.5 x H 6 cm, Ø 5 cm - 25 ml

SET OF 4 SHOT GLASSES

- Material: transparent glass

SET DI 4 BICCHIERINI DA LIQUORE

- Materiale: vetro trasparente

ENSEMBLE DE 4 MINI VERRES À LIQUEUR

- Matériau : verre transparent

SET DE 4 VASOS DE CHUPITO

- Material: cristal transparente

SET MIT 4 MINI-LIKÖRGLÄSERN

- Material: transparentem Glas



PACKAGING

PVC box
L 11.5 x H 8.5 x W 11.5 cm

SOLD X 4

SHOT0001



8 052783 614983



POPCORN BUCKET

Ø 17.5 cm, H 17.5 cm

POPCORN BUCKET

- Material: polypropylene

CONTENITORE PER POPCORN

- Materiale: polipropilene

BOÎTE À POPCORN

- Matériau : polypropylène

CUBO PARA PALOMITAS

- Material: polipropileno

POPCORNBEHÄLTER

- Material: Polypropylen

SOLD X 6

PCB0001



8 051739 306743



KITCHEN TIMER

KITCHEN TIMER

- 60 minutes, manually adjustable
- Material: plastic

TIMER DA CUCINA

- 60 minuti, regolabile manualmente
- Materiale: plastica

MINUTEUR DE CUISSON

- 60 minutes, réglable manuellement
- Matériau : plastique

TEMPORIZADOR DE COCINA

- 60 minutos, regulable manualmente
- Material: plástico

KÜCHEN-TIMER

- 60 Minuten, manuell einstellbar
- Material: Kunststoff



No batteries needed

LADYBUG
KT0001



8 052783 615515



Ø 6 cm, H 4 cm

PACKAGING

PVC box w/hook
L 7 x H 10.5 x W 6.5 cm
SOLD X 4



PANDA
KT0002



8 052783 615522



Ø 6 cm, H 5 cm

PACKAGING

PVC box w/hook
L 7 x H 10.5 x W 6.5 cm
SOLD X 4



AVOCADO
KT0003



8 059174 834418



Ø 6 cm, H 9 cm

PACKAGING

PVC box w/hook
L 6.7 x H 14 x W 6.5 cm
SOLD X 4



MAGNETIC KITCHEN TIMER

Ø 7.4 cm, H 3.5 cm

MAGNETIC KITCHEN TIMER

- 60 minutes, manually adjustable
- Material: enameled steel

TIMER DA CUCINA MAGNETICO

- 60 minuti, regolabile manualmente
- Materiale: acciaio smaltato

MINUTEUR DE CUISSON AIMANTÉ

- 60 minutes, réglable manuellement
- Matériau : acier émaillé

* While stock lasts



No batteries needed

TEMPORIZADOR MAGNÉTICO DE COCINA

- 60 minutos, regulable manualmente
- Material: acero esmaltado

MAGNETISCHER KÜCHEN-TIMER

- 60 Minuten, manuell einstellbar
- Material: emaillierter Stahl

PACKAGING

cardboard box
L 7.5 x H 10.5 x W 3.7 cm
SOLD X 2



TIM0001 RED



8 058093 949371



* TIM0003 AQUA



8 058093 949395

MUSIC NOTE TEA INFUSER

L 7.5 x H 10 x W 2.5 cm

TEA INFUSER

• Material: silicone

INFUSORE PER TÈ

• Materiale: silicone

INFUSEUR À THÉ

• Matériau : silicone

INFUSOR PARA TÉ

• Material: silicona

GLASFILTER FÜR TEE

• Material: Silikon

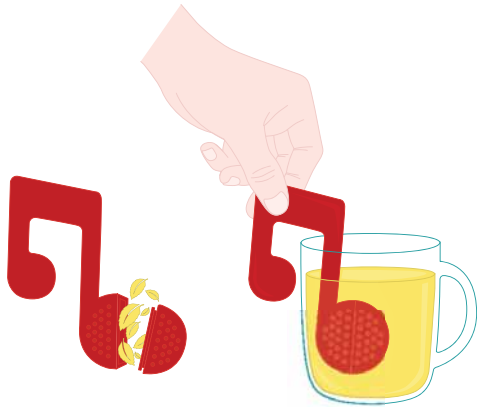

PACKAGING

cardboard box
L 9 x H 12.5 x W 3 cm

SOLD X 6



INF0001 BLACK



INF0002 RED



TEA INFUSER

Ø 2.2 cm, H 13.3 cm

TEA INFUSER

• Material: borosilicate glass, wooden lid, silicone seal

INFUSORE PER TÈ

• Materiale: vetro borosilicato, tappo in legno, guarnizione in silicone

INFUSEUR À THÉ

• Matériau : verre borosilicate, bouchon en bois, joint en silicone

INFUSOR PARA TÉ

• Material: vidrio de borosilicato, tapón en madera, junta de sellado en silicona

GLASFILTER FÜR TEE

• Material: Borosilikatglas, Deckel aus Holz, Dichtung aus Silikon



PACKAGING

cardboard box
L 5.1 x H 15.8 x W 3 cm



DISPLAY

material: cardboard
L 16 x H 22 x W 13 cm

12 PCS

TEAKIT1

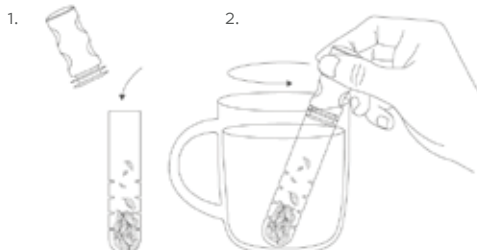

LUNCH BOX

L 18 x H 10 x W 10 cm

LUNCH BOX

- Durable material
- Hermetic closure
- Material: PS, PE, PP, polyester

CONTENITORE PORTA PRANZO

- Materiale durevole
- Chiusura ermetica
- Materiale: PS, PE, PP, poliester

BOÎTE REPAS

- Matériau durable
- Fermeture hermétique
- Matériau : PS, PE, PP, polyester

FIAMBRERA

- Material duradero
- Cierre hermético
- Material: PS, PE, PP, poliéster

LUNCHBOX

- Haltbares Material
- Hermetisch dichter Verschluss
- Material: PS, PE, PP, Polyester



Without lid and trays

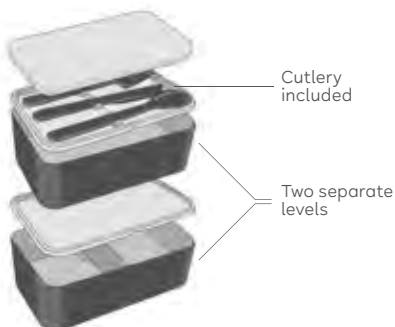

PACKAGING
cardboard box
L 20 x H 11 x
W 11 cm
SOLD X 2

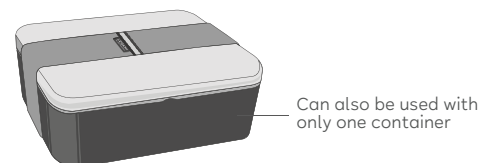

TRAVEL
LUB0001



8 051739 309287



TROPICAL
LUB0002



8 051739 309294

LUNCH BAG

L 21 x H 37 x W 12.5 cm (handles included)

LUNCH BAG

- Durable, heat-insulating and spacious
- Removable and adjustable shoulder strap
- Material: polyester exterior, EVA interior, foam padding

BORSA PORTA PRANZO

- Resistente, termoisolante e capiente
- Tracolla rimovibile e regolabile
- Materiale: esterno in poliester, interno in EVA, imbottitura in spugna

SAC À REPAS

- Résistant, isotherme et de grande capacité
- Bandoulière amovible et réglable
- Matériau : extérieur en polyester, intérieur en EVA, rembourrage en mousse

BOLSA PARA COMIDA

- Resistente, con aislamiento térmico y con gran capacidad
- Bandolera removible y regulable
- Material: exterior en poliéster, interior en EVA, acolchado en espuma

LUNCHTASCHE

- Haltbare, wärmeisolierte und groß
- Abnehmbarer und verstellbarer Trageriemen
- Material: Außen aus Polyester, Innen aus EVA, Innenfutter aus Frottee



PACKAGING
cardboard belly band
L 21 x H 25 x W 5 cm
SOLD X 2



TRAVEL
LBAG0001



8 059174 832315

Shoulder strap:
MIN 70 cm
MAX 130 cm



TROPICAL
LBAG0002



8 059174 832322

LIGHTING

FOR INDOOR
USE ONLY

UNDER THE RAINBOW

L 190 cm

STRING OF RAINBOW-SHAPED LED LIGHTS

- With 20 LEDs
- Silver-coloured wire
- Light colour: warm white
- Material: copper wire, PS

FILO DI LUCI LED A FORMA DI ARCOBALENO

- Con 20 LED
- Filo color argento
- Colore luce: bianco caldo
- Materiale: filo in rame, PS

GUIRLANDE LUMINEUSE LED EN FORME D'ARC-EN-CIEL

- Avec 20 LED
- Guirlande de couleur argent
- Couleur de la lumière : blanche chaude
- Matériau : guirlande en cuivre, PS

CABLE DE LUCES LED EN FORMA DE ARCOÍRIS

- Con 20 luces LED
- Cable de color plata
- Color de la luz: blanco cálido
- Material: cable de cobre, PS

LED-LICHTERKETTE IN REGENBOGENFORM

- Mit 20 LEDs
- Silberfarbener Draht
- Lichtfarbe: Warmweiß
- Material: Kupferdraht, PS

PACKAGING

window box w/ hook and w/ try me
L 12 x H 8.8 x W 4 cm

SOLD X 6

STRI0005



8 052461 962498

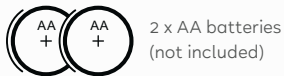

2 x AA batteries
(not included)



COPPER WIRE LIGHTS WITH PHOTO HOLDER CLIPS

L 190 cm

COPPER WIRE LIGHTS WITH PHOTO HOLDER CLIPS

- Composed of 20 LEDs. With 20 removable clips
- Light colour: warm white
- Material: copper wire, plastic

FILO DI LUCINE IN RAME CON CLIP PORTAFOTO

- Composto da 20 LED. Con 20 clip removibili
- Colore luce: bianco caldo
- Materiale: filo in rame, plastica

GUIRLANDE LUMINEUSE EN CUIVRE AVEC CLIPS PORTE PHOTOS

- Composée de 20 LED. Avec 20 clips amovibles
- Couleur de la lumière : blanche chaude
- Matériau : guirlande en cuivre, plastique

CABLE DE COBRE CON LUCES DE CLIP PARA FOTOS

- Compuesto por 20 luces LED. Con 20 clips extraíbles
- Color de la luz: blanco cálido
- Material: cable de cobre, plástico

LICHTERKETTE AUS KUPFERDRAHT MIT CLIPS FÜR FOTOS

- Bestehend aus 20 LEDs. Mit 20 abnehmbaren Clips
- Lichtfarbe: Warmweiß
- Material: Kupferdraht, Kunststoff

PACKAGING

window box w/ hook and w/ try me
L 11 x H 9 x W 3.5 cm

SOLD X 6

CSTR0001



8 052461 962504

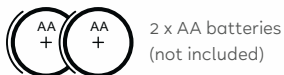

2 x AA batteries
(not included)



FOR INDOOR
USE ONLY

FOR INDOOR
USE ONLY

LED LIGHT SPOOL

Ø 7.5 cm, H 9.8 cm (string length 100 cm)

LED LIGHT SPOOL

- With 100 LEDs
- Light colour: warm white
- Material: copper wire, pine wood

ROCCHETTO CON LUCI A LED

- Con 100 LED
- Colore luce: bianco caldo
- Materiale: filo in rame, legno di pino

BOBINE AVEC GUIRLANDE LUMINEUSE LED

- Avec 100 LED
- Couleur de la lumière : blanche chaude
- Matériau : guirlande en cuivre, bois de pin

CARRETE DE LUCES LED

- Con 100 luces LED
- Color de la luz: blanco cálido
- Material: cable de cobre, madera de pino

SPULE MIT LED-LICHTERKETTE

- Mit 100 LEDs
- Lichtfarbe: Warmweiß
- Material: Kupferdrah, Kiefernholz



3 x AA batteries
(not included)



PACKAGING

window box w/try me
L 8.5 x H 13 x W 8.5 cm

SOLD X 2

LIG0001



8 059174 833343



FOR INDOOR
USE ONLY

BOTTLE LIGHTS

Ø 2.2 cm (upper cap part), H 5 cm (string excluded) (string length: 140 cm)

BOTTLE LIGHTS

- With 15 LEDs
- Light colour: warm white
- Material: copper wire, plastic cap

LUCI PER BOTTIGLIA

- Con 15 LED
- Colore luce: bianco caldo
- Materiale: filo in rame, tappo in plastica

LAMPES POUR BOUTEILLE

- Avec 15 LED
- Couleur de la lumière : blanche chaude
- Matériau : guirlande en cuivre, bouchon en plastique

LUCES PARA BOTELLA

- Con 15 luces LED
- Color de la luz: blanco cálido
- Material: cable de cobre, tapón de plástico

FLASCHENLICHT

- Mit 15 LEDs
- Lichtfarbe: Warmweiß
- Material: Kupferdrah, Kunststoffverschluss

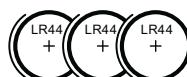

3 x LR44 batteries
(included)



DO NOT IMMERSE
IN LIQUIDS

PACKAGING

carded
L 8.5 x H 21cm

SOLD X 8

BLL0001



8 059174 834722

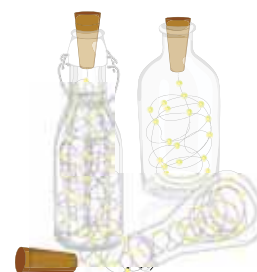

FOR INDOOR
USE ONLY

STRING OF LED LIGHTS WITH MINI GLASS JARS

L 185 cm

STRING OF LED LIGHTS WITH MINI GLASS JARS

- With 10 LEDs
- Light colour: warm white
- Material: copper wire, glass

FILO DI LUCI LED CON VASETTI DI VETRO

- Con 10 LED
- Colore luce: bianco caldo
- Materiale: filo in rame, vetro

GUIRLANDE LUMINEUSE À LED AVEC DES BOCAUX EN VERRE

- Avec 10 LED
- Couleur de la lumière : blanche chaude
- Matériau : guirlande en cuivre, verre

CABLE DE LUCES LED CON TARROS DE CRISTAL

- Con 10 luces LED
- Color de la luz: blanco cálido
- Material: cable de cobre, cristal

LED-LICHTERKETTE MIT GLÄSERN

- Mit 10 LEDs
- Lichtfarbe: Warmweiß
- Material: Kupferdrah, Glas



2 x AA batteries
(not included)



PACKAGING

window box w/hook
and w/try me
L 21 x H 15 x W 3 cm

SOLD X 4

STRI0001



8 052783 613672



FOR INDOOR
USE ONLY

COPPER WIRE LIGHTS

L 190 cm

COPPER WIRE LIGHTS

- With 20 LEDs
- Light colour: warm white
- Material: copper wire

FILO DI LUCINE IN RAME

- Con 20 LED
- Colore luce: bianco caldo
- Materiale: filo in rame

GUIRLANDE LUMINEUSE EN CUIVRE

- Avec 20 LED
- Couleur de la lumière : blanche chaude
- Matériau : guirlande en cuivre

CABLE DE COBRE CON LUCES

- Con 20 luces LED
- Color de la luz: blanco cálido
- Material: cable de cobre

LICHTERKETTE AUS KUPFERDRAHT

- Mit 20 LEDs
- Lichtfarbe: Warmweiß
- Material: Kupferdrah



2 x AA batteries
(not included)



PACKAGING

window box w/try me
L 6 x H 12 x W 3.5 cm



DISPLAY

material: cardboard
L 19.5 x H 20 x W 16.5 cm

12 PCS

COSKIT1



8 051128 752205



FOR INDOOR
USE ONLY

MINI DECORATIVE LIGHTS

L MAX 14 x H MAX 15 x W 3.3 cm

MINI DECORATIVE LIGHTS

- Light colour: warm white
- Material: metal, wood, plastic

MINI LUCI DECORATIVE

- Colore luce: bianco caldo
- Materiale: metallo, legno, plastica

MINI LAMPES DÉCORATIVES

- Couleur de la lumière : blanche chaude
- Matériau : métal, bois, plastique

* While stock lasts



3 x LR44 batteries
(included)

MINILUCES DECORATIVAS

- Color de la luz: blanco cálido
- Material: metal, madera, plástico

DEKORATIVE MINI-LICHTER

- Lichtfarbe: Warmweiß
- Material: Metall, Holz, Kunststoff

PACKAGING

window box w/hook
L MAX 15 x H MAX 18.5 x W 4 cm
SOLD X 3

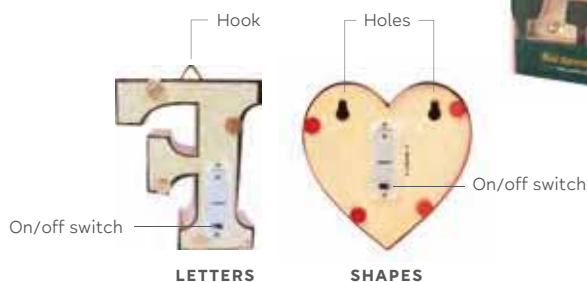

LETTERS

SHAPES



LELI0001



LELI0002



LELI0003



LELI0004



LELI0005



LELI0006



LELI0007



LELI0008



LELI0009



LELI0010



LELI0011



LELI0012



LELI0013



LELI0014



LELI0015



LELI0016



LELI0017



LELI0018



LELI0019



LELI0020



LELI0021



LELI0022



LELI0023



LELI0024



LELI0025



LELI0026



LELI0027



MINI DECORATIVE LIGHTS RANGE
3 PCS X LETTER





CLOUD

LELI0035 *



8 052783 617830



FLAMINGO

LELI0040



8 059174 834227



UNICORN

LELI0041



8 059174 834234



STAR

LELI0042



8 059174 839581



CACTUS

LELI0043



8 059174 839598



HEART

LELI0044



8 059174 839604

MINI DECORATIVE LIGHTS RANGE
3 PCS X SHAPE



8 054320 564379

DISPLAY ON DEMAND



MINI DECORATIVE LIGHTS
RANGE + DISPLAY

Ø 50, H 190 cm

Double-sided spinner display

Swivel wheels

42 hooks

Material: metal

Assortment:

- 5 pcs x shape

- 5 pcs x A, G, L, M, R, S

- 3 pcs x B, C, D, E, F, H, I, J, K,
N, O, P, Q, T, U, V, W, X, Y, Z, &



8 054320 561255

FOR INDOOR
USE ONLY

LED LIGHT

L 7.5 x H 11.3 x W 1.5 cm

LED LIGHT

- Ideal for wardrobes, bathrooms, corridors, basements, and more
- 6 LED lights
- Power: 36 lumens
- Material: plastic

LUCE A LED

- Ideale per armadi, bagni, corridoi, cantine e molto altro ancora
- 6 luci LED
- Potenza: 36 Lumen
- Materiale: plastica

LAMPE À LED

- Idéale pour les armoires, salles de bains, couloirs, caves et bien d'autres encore
- 6 lampes à LED
- Puissance : 36 Lumen
- Matériau : plastique

LUZ LED

- Ideal para armarios, baños, pasillos, sótanos y mucho más
- 6 luces LED
- Potencia: 36 lúmenes
- Material: plástico

LED-LICHT

- Ideal für Schränke, Bäder, Flure, Keller und vieles andere mehr
- 6 LED-Leuchten
- Stärke: 36 Lumen
- Material: Kunststoff



3 x AAA batteries
(not included)

PACKAGING

carded
L 13 x H 20.5 x W 4 cm

SOLD X 4

NTL0001



8 058093 949418



Self-standing
packaging



Hole for
fixing

On/off switch

Adhesive
backing

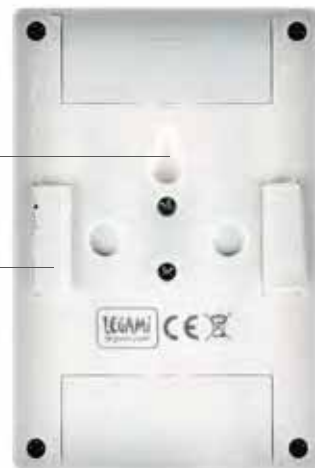

HANGING LAMP

Ø 5.5 cm, H 16 cm

HANGING LAMP WITH CORD

- 1 watt LED warm white light
- Water resistant IP44: ideal for both indoor and outdoor use
- Material: plastic, fabric cord

LAMPADA A SOSPENSIONE CON CORDA

- Luce LED bianca calda da 1 Watt
- Resistente all'acqua IP44: ideale sia per l'interno che per l'esterno
- Materiale: plastica, cordino in tessuto

LAMPE À SUSPENSION AVEC CORDON

- Lampe à LED blanche chaude de 1 Watt
- Résistante à l'eau IP44 : idéale à l'intérieur, comme à l'extérieur
- Matériau : plastique, cordon en tissu

LÁMPARA DE SUSPENSIÓN CON CUERDA

- Luz LED blanco cálido de 1 Watt
- Resistente al agua IP44: ideal tanto para interior como para exterior
- Material: plástico, cuerda de tejido

HÄNGELAMPE MIT KABELSCHNUR

- LED-Lampe mit weichem weißem Licht von 1 Watt
- Wasserfest IP44: Ideal sowohl für Innen- als auch für Außenräume
- Material: Kunststoff, Schnur aus Stoff

* While stock lasts



3 x AAA batteries
(not included)

PACKAGING

carded
L 14.5 x H 23 x W 6 cm

SOLD X 4

HL0001 *



8 058093 949661



Self-standing
packaging

46 cm



Water Resistant

RETRO ALARM CLOCK

L 10.9 x H 8.7 x W 6 cm

VINTAGE INSPIRED ALARM CLOCK

- Ivory face and glow-in-the-dark hands
- Material: plastic

OROLOGIO-SVEGLIA VINTAGE

- Quadrante avorio e lancette che si illuminano al buio
- Materiale: plastica

HORLOGE-RÉVEIL VINTAGE

- Cadran couleur ivoire et aiguilles qui s'éclairent dans l'obscurité
- Matériau : plastique

RELOJ DESPERTADOR VINTAGE

- Esfera marfil y agujas que se iluminan en la oscuridad
- Material: plástico

VINTAGE-WECKER

- Elfenbeinfarbenes Zifferblatt und im Dunkeln leuchtende Zeiger
- Material: Kunststoff

PACKAGING

window box
L 12 x H 11.3 x W 7 cm
SOLD X 2



1 x AA battery
(not included)

MINI TICK TOCK

L 4.5 x H 5.8 x W 2 cm

ALARM CLOCK

- Material: matte metal

OROLOGIO-SVEGLIA

- Materiale: metallo opaco

HORLOGE-RÉVEIL

- Matériau : métal opaque

RELOJ DESPERTADOR

- Material: metal opaco

WECKER

- Material: mattes Metall



1 x LR44H battery
(included)

PACKAGING

PET box w/hook
L 4.5 x H 6.5 x W 2 cm

FIRST ORDER: MOQ 1 FULL ASSORTED DISPLAY (16 PCS)

material: cardboard
L 19.5 x H 11.5 x W 10 cm
16 PCS: 3 X SVE0023, 3 X SVE0024, 2 X SVE0025, 3 X SVE0026, 2 X SVE0027, 3 X SVE0028



INDIVIDUAL COLOURS: SOLD X 3



BAMBOO FOLDING STAND

L 28 x H 20 x W 2.5 cm (closed)
L 28 x H MAX 20 x W MAX 20 cm (open)

BAMBOO FOLDING STAND

- Practical stand for tablets, books, recipe books or sheet music
- Material: bamboo, stainless steel

LEGGIO PIEGHEVOLE IN BAMBOO

- Pratico supporto per tablet, libri, ricettari o spartiti
- Materiale: bamboo, acciaio inox

PUPITRE PLIABLE EN BAMBOU

- Support pratique pour tablettes, livres, recueils de recettes ou partitions
- Matériau : bambou, acier inox

ATRIL PLEGABLE DE BAMBÚ

- Práctico soporte para tabletas, libros, recetarios o partituras
- Material: bambú, acero inoxidable

KLAPPPULT AUS BAMBUS

- Praktischer Ständer für Tablets, Bücher, Rezeptsammlungen oder Noten
- Material: Bambus, Edelstahl

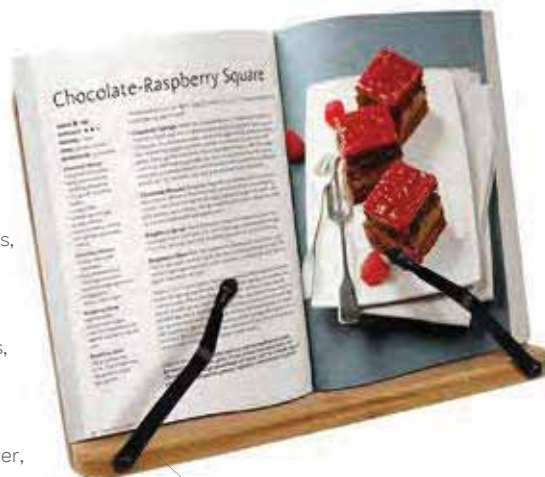

Stainless steel folding page-holders

PACKAGING

cardboard box
L 27 x H 20 x W 4 cm
SOLD X 4



Reclinable: 5 different tilt angles



FOLDING STOOL

L 39.5 x H 30 x W 21.5 cm (open)

FOLDING STOOL

- Space-saving closable stool
- Material: PP, metal screws

SGABELLO PIEGHEVOLE

- Sgabello richiudibile salvaspazio
- Materiale: PP, viti in metallo

ESCABEAU PLIANT

- Escabeau repliable et peu encombrant
- Matériau : PP, vis en métal

TABURETE PLEGABLE

- Taburete plegable compacto
- Material: PP, metal screws

KLAPPHOCKER

- Platzsparender Klapphocker
- Material: PP, metal screws

PACKAGING

Shrink-wrapping
L 39.5 x H 44 x W 5.5 cm

SOLD X 4

FS0001



8 059174 839680



Up to
150 kg

SLAM DUNK

Ø 32 cm, H 30 cm

BASKETBALL BIN

- Material: plastic

CESTINO A FORMA DI CANESTRO

- Materiale: plastica

CORBEILLE PANIER DE BASKET

- Matériau : plastique

PAPELERA BALONCESTO

- Material: plástico

BASKETBALL-KORB MÜLLEIMER

- Material: Kunststoff

PACKAGING

cardboard belly band
SOLD X 6

BTC0001



8 052461 961491



SECRET ROCK

L 10.3 x H 5.5 x W 9 cm

KEY-HIDER STONE

- Reclosable compartment
- Material: polyresin, plastic

SASSO NASCONDI CHIAVE

- Scpartimento richiudibile
- Materiale: poliresina, plastica

PIERRE CACHE-CLÉ

- Compartiment refermable
- Matériau : polyrésine, plastique

PIEDRA ESCONDE LLAVE

- Compartimento recerrable
- Material: poliresina, plástico

STEIN ZUM VERSTECKEN VON SCHLÜSSELN

- Wiederverschließbares Fach
- Material: Polyresin, Kunststoff

DISPLAY

material: cardboard
L 19.5 x H 23.5 x W 22.5 cm

8 PCS

ROCKKIT1



8 051128 752267



Top



Bottom



SEWING KIT

Ø 8 cm, H 16 cm

SEWING KIT

- Retro style glass jar with a soft lid that can be used as a pincushion
- Sewing kit complete with lots of accessories
- Material: glass jar, soft lid with pincushion

KIT PER CUCITO

- Barattolo di vetro dallo stile retrò con tappo morbido che consente di appuntare aghi e spilli
- Kit per cucito completo di tanti accessori
- Materiale: barattolo in vetro, tappo morbido con cuscino

KIT DE COUTURE

- Bocal en verre au style rétro avec couvercle mou qui permet d'y épingler des aiguilles et des épingles
- Kit de couture avec de nombreux accessoires
- Matériau : bocal en verre, couvercle mou avec coussin

KIT DE COSTURA

- Bote de vidrio en estilo retro con tapón blando que permite clavar agujas y alfileres
- Kit de costura completo de accesorios
- Material: bote de vidrio, tapón blando con almohadilla

NÄHSET

- Glasbehälter im Retro-Stil mit weichem Deckel, der als Nadelkissen dient
- Vollständiges Nähset mit vielen Accessoires
- Material: Behälter aus Glas, weicher Deckel mit Nadelkissen

PACKAGING

cardboard box
L 8.5 x H 16.2 x W 8.5 cm

SOLD X 4

SEW0001



8 056304 489937



LOVE IS THE ANSWER

L 10 x H 10 x W 7 cm

HEART OF ANSWERS

- Contains a multi-sided dice with 20 possible answers (in English)
- Material: ABS

CUORE DELLE RISPOSTE

- Contiene un dado a più facce con 20 possibili risposte (in lingua inglese)
- Materiale: ABS

CŒUR À RÉPONSES

- Il contient un dé à plusieurs faces comptant 20 réponses possible (fournies en anglaise)
- Matériau : ABS

CORAZÓN DE LAS RESPUESTAS

- Contiene un dado de varias caras con 20 posibles respuestas (escritas en inglés)
- Material: ABS

HERZ DER ANTWORTEN

- Enthält einen Würfel mit mehreren Seiten und mit 20 möglichen Antworten (in englischer Sprache)
- Material: ABS

PACKAGING

cardboard box
L 10.5 x H 8.5 x W 10.3 cm

SOLD X 4

LIA0001



No batteries needed

OUR LOVE IS FOREVER

L 4 x H 6.5 x W 2 cm

LOVERS' PADLOCK

- 2 keys included
- Material: metal

LUCCHETTO DEGLI INNAMORATI

- 2 chiavi incluse
- Materiale: metallo

CADENAS D'AMOUR

- 2 clés incluses
- Matériau : métal

CANDADO DE LOS ENAMORADOS

- Incluye 2 llaves
- Material: metal

VORHÄNGESCHLOSS FÜR VERLIEBTE

- Inklusive 2 Schlüssel
- Material: Metall

PACKAGING

window box
L 11.7 x H 14.7 x W 3.5 cm

SOLD X 4

LOV0001

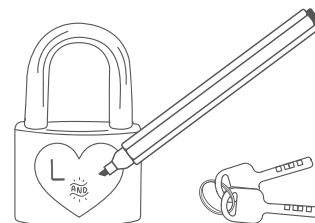

MAGNETIC HOURGLASS

L 8 x H 16.5 x W 8 cm (base included)

MAGNETIC HOURGLASS

- Hourglass with ferrous powder
- Magnetic wooden base

CLESSIDRA MAGNETICA

- Clessidra con polvere di ferro
- Base in legno magnetica

SABLIER MAGNÉTIQUE

- Sablier avec de la poudre de fer
- Base en bois magnétique

RELOJ DE ARENA MAGNÉTICO

- Reloj de arena con polvo de hierro
- Base magnética de madera

MAGNETISCHE SANDUHR

- Sanduhr mit Eisenpulver
- Magnetholzbasis

PACKAGING

cardboard box
L 9 x H 20 x W 9 cm

SOLD X 4

HG0001

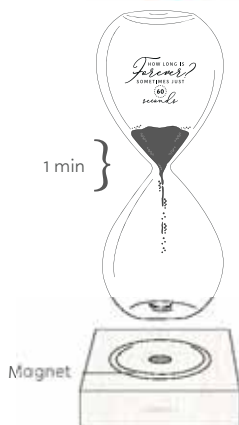

PEACE OF MIND

H 24.5 cm

HEAD MASSAGER

- Contains 12 flexible metal arms
- Material: metal handle, wooden grip

MASSAGGIATORE PER LA TESTA

- 12 bracci in metallo flessibile
- Materiale: manico in metallo, impugnatura in legno

MASSEUR DE TÊTE

- 12 branches en métal flexible
- Matériau : manche en métal, poignée en bois

MASAJEADOR PARA LA CABEZA

- 12 brazos de metal flexible
- Material: mango de metal, empuñadura de madera

MASSAGEGERÄT FÜR DEN KOPF

- 12 flexible Metallarme
- Material: Griff aus Metall, Handgriff aus Holz

PACKAGING

PET box w/ hook
L 6 x H 28 x W 6 cm



DISPLAY

material: cardboard
L 13.5 x H 38.5 x W 19.5 cm

6 PCS

HEADKIT1



PHOTO LOVERS

MAGNETIC WIRE PHOTO HOLDER

H 120 cm

MAGNETIC WIRE PHOTO HOLDER

- 7 photo clips included
- Material: plastic, metal, magnet

FILo MAGNETICO PORTA FOTO

- 7 ferma-foto inclusi
- Materiale: plastica, metallo, magnete

FIL MAGNÉTIQUE PORTE-PHOTOS

- 7 clips pour photos inclus
- Matériau : plastique, métal, aimant

CUERDA MAGNÉTICA PORTAFOTOS

- Incluye 7 clips para fotos
- Material: plástico, metal, imán

MAGNETBAND ALS FOTOHALTER

- Inklusive 7 Fotohalter
- Material: Kunststoff, Metall, Magnet



PACKAGING

carded
L 14 x H 18 cm x W 1 cm

SOLD X 3



CAMERA

CAB0014



8 056304 489876



HEART

CAB0016



8 056304 489890



CAT

CAB0018



8 056304 489913

LUCKY

L 6 x H 4.5 x W 2 cm

MAGNETIC PHOTO HOLDER

- Also ideal as a paper clip holder, business card holder, ring holder
- Material: metal, magnet

PORTAFOTO MAGNETICO

- Ideale anche come porta graffette, porta biglietti da visita, porta anelli
- Materiale: metallo, magnete

PORTE PHOTOS MAGNÉTIQUE

- Idéal aussi comme porte trombones, porte cartes de visite, porte bagues
- Matériau : métal, aimant

PORTAFOTOS MAGNÉTICO

- Ideal también como portaclips, porta tarjetas de visita, portanillos
- Material: metal, imán

MAGNETISCHER FOTOHALTER

- Ideal auch für Büroklammern, Visitenkarten oder Ringe
- Material: Metall, Magnet



PACKAGING

window box
L 9 x H 11.5 x W 4 cm

SOLD X 6

BDM0001



8 059174 839765

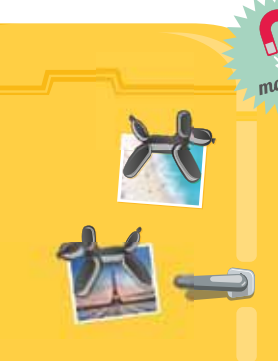

Double magnet



Photo holder



Ring holder



Paper clip holder

GLITTER PHOTO FRAME

GLITTER PHOTO FRAME

- 1 replaceable photo included
- Material: PC, liquid

PORTAFOTO CON GLITTER

- 1 fotografia sostituibile inclusa
- Materiale: PC, liquido

CADRE PHOTO AVEC PAILLETES

- 1 photo remplaçable incluse
- Matériau : PC, liquide

PORTARRETRATOS CON PURPURINA

- Incluye 1 fotografía que se puede cambiar
- Material: PC, líquido

BILDERRAHMEN MIT GLITTER

- Inklusive 1 austauschbaren Fotos
- Material: PC, Flüssigkeit



MINI
L 6.2 x H 9.4 x W 2.3 cm

PACKAGING
cardboard box
L 7.2 x H 10 x W 3.6 cm
SOLD X 4

GPF0001
8 059174 834821



SMALL
L 11.5 x H 9.5 x W 2.3 cm

PACKAGING
cardboard box
12.5 x H 10 x W 3.6 cm
SOLD X 4

GPF0002
8 059174 834838



MEDIUM
L 16 x H 11 x W 2.4 cm

PACKAGING
cardboard box
L 17 x H 12 x W 3.6 cm
SOLD X 4

GPF0003
8 059174 834845



Travel

COLLECTION



TRAVEL ORGANISER

L 11 x H 23.5 cm (closed)

TRAVEL ORGANISER

- 4 large pockets for boarding pass and passport
- 7 small pockets for credit cards and tickets
- Magnetic clasp
- RFID blocking: protects against data theft
- Material: PU with polyester internal lining

PORTA DOCUMENTI DA VIAGGIO

- 4 tasche grandi per carte d'imbarco e passaporto
- 7 tasche piccole per carte di credito e ticket
- Chiusura magnetica
- Protezione RFID: protegge dal furto dei dati
- Materiale: PU con fodera interna in poliestere

PORTE-DOCUMENTS DE VOYAGE

- 4 grandes pochettes pour les cartes d'embarquement et le passeport
- 7 petites pochettes pour les cartes de crédit et les tickets
- Fermeture magnétique
- Protection RFID : protège du vol de données
- Matériau : PU avec doublure intérieure en polyester

PORTA DOCUMENTOS DE VIAJE

- 4 bolsillos grandes para tarjetas de embarque y pasaporte
- 7 bolsillos pequeños para tarjetas de crédito y tiques
- Cierre magnético
- Protección RFID: protege del robo de datos
- Material: PU con forro interno de poliéster

REISEDOKUMENTENTASCHE

- 4 große Fächer für Bordkarten und Reisepass
- 7 kleine Fächer für Kreditkarten und Tickets
- Magnetverschluss
- RFID-Schutz: schützt vor Datendiebstahl
- Material: PU mit Innenfutter aus Polyester

SOLD X 3

PACKAGING

plastic bag
L 14.5 x H 30.5 cm



EMPTY DISPLAY ON DEMAND

material: cardboard
L 15.5 x H 35 x W 22 cm
minimum order qty: 18 pcs



DISTO



8 055748 241996

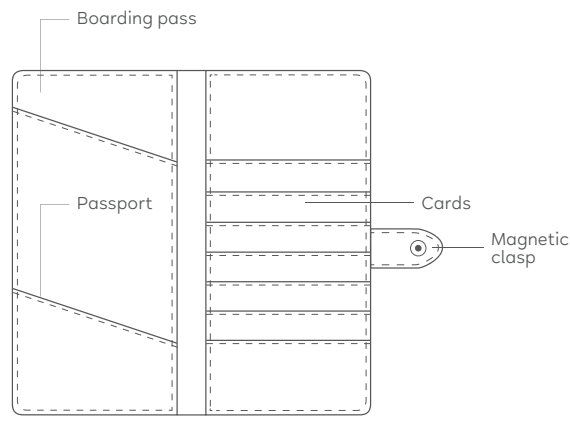

22 cm





PASSPORT HOLDER

L 10.5 x H 14 cm (closed)

PASSPORT HOLDER

- 1 passport pocket
- 4 pockets for credit cards and tickets
- RFID blocking: protects against data theft
- Material: PU with polyester internal lining

PORTA PASSAPORTO

- 1 tasca per il passaporto
- 4 tasche per carte di credito e ticket
- Protezione RFID: protegge dal furto dei dati
- Materiale: PU con fodera interna in poliester

PORTE-PASSEPORT

- 1 pochette pour le passeport
- 4 pochettes pour les cartes de crédit et les tickets
- Protection RFID : protège du vol de données
- Matériau : PU avec doublure intérieure en polyester

PORTA PASAPORTE

- 1 bolsillo para el pasaporte
- 4 bolsillos para tarjetas de crédito y tiques
- Protección RFID: protege del robo de datos
- Material: PU con forro interno de poliéster

REISEPASSHÜLLE

- 1 Fach für den Reisepass
- 4 Fächer für Kreditkarten und Tickets
- RFID-Schutz: schützt vor Datendiebstahl
- Material: PU mit Innenfutter aus Polyester

* While stock lasts

SOLD X 3

PACKAGING

plastic bag
L 13.5 x H 20.5 cm



EMPTY DISPLAY ON DEMAND

material: cardboard
L 15.5 x H 25.5 x W 17.5 cm
minimum order qty: 18 pcs

DISPH



8 055748 242016

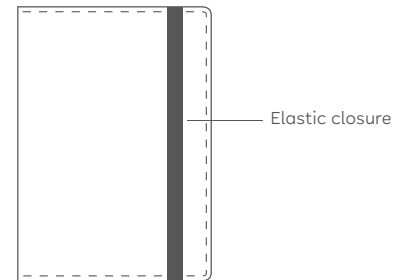
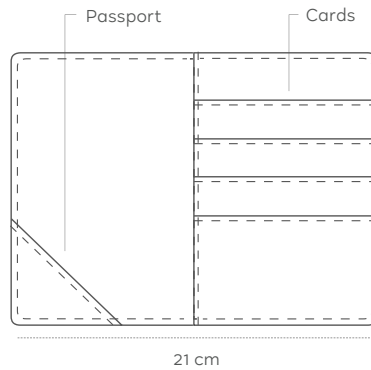

BADGE HOLDER

L 10.4 x H 9 cm

BADGE HOLDER

- Dimensions for inserting badge or business cards: 9,5 x 6,5 cm
- Lanyard with snap hook and safety clip clasp
- Material: PU with polyester internal lining

PORTA BADGE

- Dimensioni utili del badge o dei biglietti da visita inseribili: 9,5 x 6,5 cm
- Cordino con moschettone e chiusura con clip di sicurezza
- Materiale: PU con fodera interna in poliester

PORTE-BADGE

- Dimensions du badge ou de la carte de visite insérables : 9,5 x 6,5 cm
- Cordelette avec mousqueton et fermeture avec clip de sécurité
- Matériau : PU avec doublure intérieure en polyester

PORTA TARJETA DE IDENTIFICACIÓN

- Dimensiones de la tarjeta identificativa o tarjeta de visita: 9,5 x 6,5 cm
- Cuerda con mosquetón y cierre con clip de seguridad
- Material: PU con forro interno de poliéster

NAMENSSCHILDHALTER

- Maße des einzusteckenden Namensschildes oder der Visitenkarte: 9,5 x 6,5 cm
- Band mit Karabinerhaken und Sicherheits- Clipverschluss
- Material: PU mit Innenfutter aus Polyester

SOLD X 3

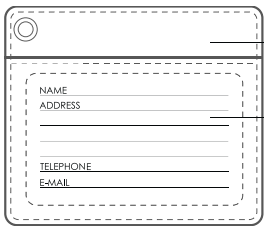

Your badge

Space for your personal data

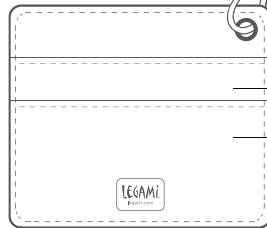

ID card

Driving licence



Safety clip clasp

PACKAGING

plastic bag
L 12 x H 19.5 cm



EMPTY DISPLAY ON DEMAND

material: cardboard
L 13.5 x H 24.5 x
W 23.5 cm
minimum order qty:
18 pcs

DISBH



BH0023 RED



BH0024 TURQUOISE



BH0026 BLACK



BH0029 PETROL BLUE





CARD HOLDER

L 11.5 x H 7.5 cm (closed)

CARD HOLDER

- RFID blocking: protects against data theft
- Material: PU with 10 plastic inserts

PORTA CARTE DI CREDITO

- Protezione RFID: protegge dal furto dei dati
- Materiale: PU con 10 bustine trasparenti

✳ While stock lasts

SOLD X 3



CCH0019 BLACK



8 056304 487278



CCH0020 LILAC ✳



8 056304 487285



CCH0021 MAGENTA



8 056304 487292



CCH0022 PETROL BLUE



8 059174 835750

PORTE CARTE DE CRÉDIT

- Protection RFID : protège du vol de données
- Matériau : PU avec 10 pochettes transparentes

TARJETERO

- Protección RFID: protege del robo de datos
- Material: PU con 10 fundas transparentes

KREDITKARTENETUI

- RFID-Schutz: schützt vor Datendiebstahl
- Material: PU mit 10 durchsichtigen Hüllen

EMPTY DISPLAY ON DEMAND

material: cardboard
L 11 x H 23 x W 21 cm
minimum order qty: 18 pcs

DISCCH



8 055748 242023



PACKAGING

plastic bag
L 10.5 x H 17.5 cm



Elastic closure



10 Plastic inserts

23 cm

LUGGAGE TAG

L 4 x H 24.5 cm

LUGGAGE TAG

- Space for personal data
- Material: PU, microfibre

ETICHETTA BAGAGLIO

- Spazio per dati personali
- Materiale: PU, microfibra

ÉTIQUETTE DE BAGAGE

- Espace pour les données personnelles
- Matériau : PU, microfibre

ETIQUETA PARA EQUIPAJE

- Espacio para datos personales
- Material: PU, microfibra

KOFFERETIKETT

- Platz für persönliche Daten
- Material: PU, Mikrofaser



LUG0010 RED



8 056304 487124



LUG0011 TURQUOISE



8 056304 487131



LUG0013 BLACK



8 056304 487155



LUG0016 PETROL BLUE



8 059174 835743

PACKAGING

plastic bag
L 7 x H 24.5 cm

SOLD X 3



LUGGAGE STRAP

L 200 x H 5 cm

LUGGAGE STRAP

- Adjustable and durable
- Velcro closure
- Material: polyester, PU, metal

CORREA PARA MALETA

- Ajustable y resistente
- Cierre con velcro
- Material: poliéster, PU, metal

HOW TO USE:

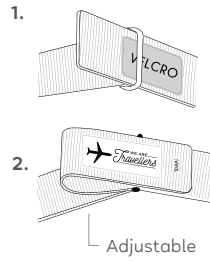

PACKAGING

PET and cardboard box w/hook
L 6 x H 20.8 x W 4 cm



CINGHIA PER VALIGIA

- Regolabile e resistente
- Chiusura con velcro
- Materiale: poliester, PU, metallo

KOFFERGURT

- Regulierbar und widerstandsfähig
- Klettverschluss
- Material: Polyester, PU, Metall

SANGLE POUR VALISE

- Réglable et résistante
- Fermeture Velcro
- Matériau : polyester, PU, métal

SOLD X 2



LUBE0001 BLACK

LUBE0002 BLUE

LUBE0003 GREEN

LUBE0004 TURQUOISE

LUBE0005 BROWN

LUBE0006 MAGENTA



HANDS FREE STRAP

L 4.5 x H MIN 25.5 x W 1.5 cm - L 4.5 x H MAX 37.5 x W 1.5 cm (open)

BAG HOLDER STRAP FOR SUITCASE

- Adjustable strap
- Resistant snap buckle closure
- Also suitable as a bag hanger for clothes
- Material: polyester, plastic

CORREA PORTABOLSA PARA MALETA

- Correa ajustable
- Cierre con resistente hebilla de presión
- Adecuada también como percha de bolso
- Material: poliéster, plástico

CINGHIA PORTA BORSA PER VALIGIA

- Cinghia regolabile
- Chiusura con fibbia a scatto resistente
- Adatta anche come appendiabiti da borsa
- Materiale: poliester, plastica

KOFFERGURT FÜR KOFFER

- Verstellbarer Gurt
- Haltbarer Schnappverschluss
- Auch als an der Tasche befestigter Bügel geeignet
- Material: Polyester, Kunststoff

SANGLE PORTE SAC POUR VALISE

- Sangle réglable
- Fermeture avec boucle à clip résistante
- Elle est aussi adaptée pour accrocher des vêtements au sac
- Matériau : polyester, plastique



Adjustable strap

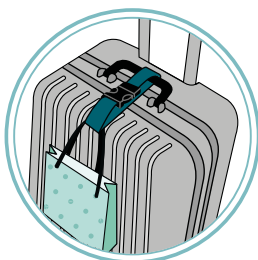

Resistant snap buckle closure, easy to hook and unhook

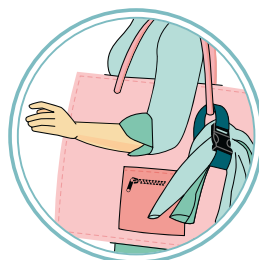

Also suitable as a bag hanger for clothes



HFB0001



PACKAGING

plastic bag
L 8 x H 22.3 x W 1.5 cm
SOLD X 3

COTTON SLEEP MASK

L 21 x H 9.5 x W 0.5 cm

SLEEP MASK

- Elastic velcro closure
- Material: cotton

MASCHERINA DA NOTTE

- Chiusura in velcro elastica
- Materiale: cotone

MASQUE DE SOMMEIL

- Fermeture Velcro élastique
- Matériau : coton

ANTIFAZ DE NOCHE

- Cierre elástico con velcro
- Material: algodón

SCHLAFMASKE

- Elastischer Klettverschluss
- Material: Baumwolle

PACKAGING

plastic bag
L 12 x H 15 x W 1.5 cm



DISPLAY

material: cardboard
L 14 x H 26 x W 22 cm
12 PCS

MASKKIT1



8 051128 750454

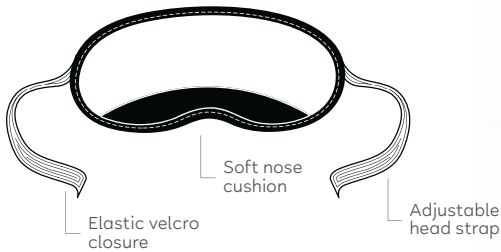

SLEEP MASK

L 20.5 x H 10 x W 1 cm



SLEEP MASK

- Elastic strap that is practical, comfortable and adjustable
- Material: polyester

MASCHERINA DA NOTTE

- Elastico regolabile, pratico e comodo
- Materiale: poliestere

MASQUE DE SOMMEIL

- Sangle élastique, pratique, confortable et réglable
- Matériau : polyester

ANTIFAZ DE NOCHE

- Sujeción con elástico, práctica, cómoda y ajustable
- Material: poliéster

SCHLAFMASKE

- Elastischer, praktischer, bequemer und regulierbarer Verschluss
- Material: Polyester

PACKAGING

window box
L 9.5 x H 23 x W 1.8 cm



DISPLAY

material: cardboard
L 11.3 x H 31 x W 15.5 cm
7 PCS

SEMKIT4



8 051128 755008



*MORE DESIGNS ON PAGE 85



MINI TRAVEL PILLOW

L 18 x H 9 x W 9 cm

MINI TRAVEL PILLOW IN MEMORY FOAM

- Small and portable
- Perfect for neck support
- The external cover can be removed and machine-washed

MINI CUSCINO DA VIAGGIO IN MEMORY FOAM

- Piccolo e portatile
- Perfetto per sostenere il collo
- Fodera esterna sfoderabile e lavabile in lavatrice

MINI COUSSIN DE VOYAGE EN MOUSSE À MÉMOIRE DE FORME

- Petit et portable
- Parfait pour soutenir le cou
- Doublure externe déhoussable et lavable en machine

MINI ALMOHADA DE VIAJE EN MEMORY FOAM

- Pequeña y portátil
- Perfecta para apoyar el cuello
- Funda exterior desenfundable y lavable en la lavadora

MINI-REISEKISSEN AUS MEMORY-SCHAUM

- Klein und tragbar
- Perfekt um den Nacken zu stützen
- Abnehmbarer und in der Waschmaschine waschbarer Außenbezug

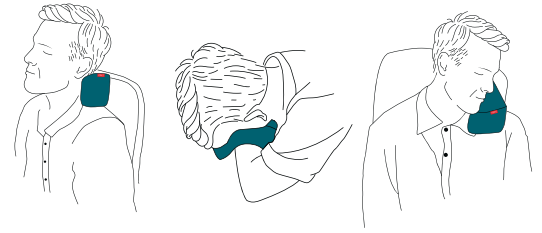

SOLD X 3



Material
Exterior: 94% Velour, 6% Spandex
Interior: 100% Memory Foam

PETROL BLUE
STP0001

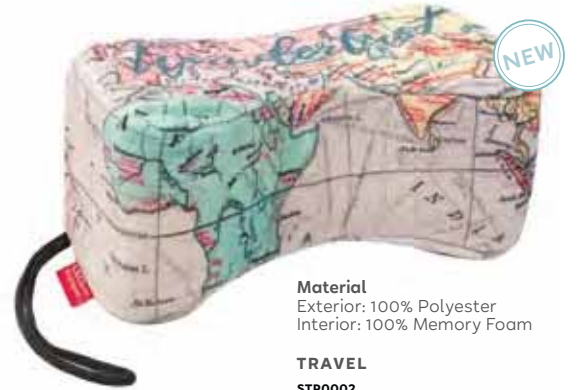

Material
Exterior: 100% Polyester
Interior: 100% Memory Foam

TRAVEL
STP0002



TRAVEL PILLOW

L 31 x H 28 x W 10 cm

TRAVEL PILLOW IN MEMORY FOAM

- The external cover can be removed and machine-washed
- Material: exterior: 94% Velour, 6% Spandex; interior: 100% Memory Foam

CUSCINO DA VIAGGIO IN MEMORY FOAM

- Fodera esterna sfoderabile e lavabile in lavatrice
- Materiale: esterno: 94% velour, 6% Spandex; interno: 100% memory foam

COUSSIN DE VOYAGE EN MOUSSE À MÉMOIRE DE FORME

- Doublure externe déhoussable et lavable en machine
- Matériau : extérieur : 94 % tissu « Velour », 6% Spandex ; intérieur : 100% mousse à mémoire de forme

ALMOHADA DE VIAJE EN MEMORY FOAM

- Funda exterior desenfundable y lavable en la lavadora
- Material: exterior 94 % velour, 6 % Spandex; interior: 100 % memory foam

REISEKISSEN AUS MEMORY-SCHAUM

- Abnehmbarer und in der Waschmaschine waschbarer Außenbezug
- Material: Außen 94% Velours, 6% Spandex; Innen: 100% Memory-Schaum

PACKAGING

window box w/handle
L 30 x H 28.8 x W 9 cm
SOLD X 2



TP0001 BLUE



TP0002 GREY



TP0003 TURQUOISE



TP0004 DARK RED



TRAVEL ORGANISER SET

SET OF 3 TRAVEL BAGS

- Ideal for storing clothing, shoes or travel accessories
- Material: polyester

SET DI 3 BUSTE DA VIAGGIO

- Ideale per riporre indumenti, scarpe o accessori da viaggio
- Materiale: poliestere

SET DE 3 HOUSES DE VOYAGE

- Idéal pour ranger les vêtements, les chaussures ou les accessoires de voyage
- Matériau : polyester

SET DE 3 ORGANIZADORES DE VIAJE

- Ideal para meter prendas, zapatos o accesorios de viaje
- Material: poliéster

SET MIT 3 KOFFERORGANIZERN

- Ideal für Bekleidung, Schuhe oder Reise-Accessoires
- Material: Polyester

PACKAGING

cardboard box
L 14.5 x H 25 x W 3.5 cm
SOLD X 4

TSB0001



8 052461 962047



SHOE BAG

L 23 x H 37 x W 12 cm

LARGE PACKING CUBE

L 40 x H 26 x W 10 cm

SMALL PACKING CUBE

L 26 x H 20 x W 10 cm



FOLDABLE TRAVEL BAG

L 20 x H 15 cm (folded)

L 36.5 x H 32 x W 18 cm (open, handles excluded)

FOLDABLE TRAVEL BAG

- Ultra-lightweight and super-resistant
- Maximum weight supported: 5 kg
- Material: polyester

BORSA DA VIAGGIO PIEGHEVOLE

- Ultra leggera e super resistente
- Peso massimo sopportato: 5 kg
- Materiale: poliestere

SAC DE VOYAGE PLIABLE

- Ultraléger et très résistant
- Poids maximum supporté : 5 kg
- Matériau : polyester

BOLSA DE VIAJE PLEGABLE

- Ultraligera y superresistente
- Peso máximo soportado: 5 kg
- Material: poliéster

FALTBARE REISETASCHE

- Ultraleicht und besonders haltbar
- Maximales tragbares Gewicht: 5 kg
- Material: Polyester

PACKAGING

cardboard belly band
L 20 x H 19.5 x W 5 cm
SOLD X 4

TSB0001



8 052461 962054



MAX
5KG

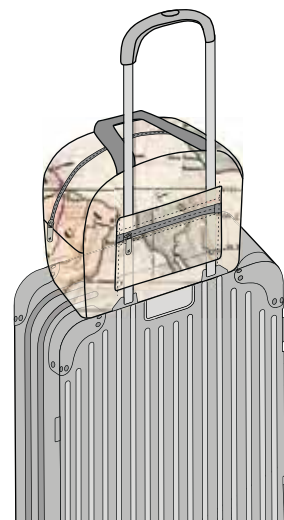

TRAVEL TOILETRY BAG

L 24 x H 15 x W 8 cm (closed)
L 24 x H 42 x W 4 cm (open, hook included)

TRAVEL TOILETRY BAG

- Perfect for travelling or for the gym, also ideal for everyday use
- Material: polyester

BEAUTY CASE DA VIAGGIO

- Perfetto per il viaggio o per la palestra, ideale anche per l'uso quotidiano
- Materiale: poliester

TROUSSE DE MAQUILLAGE DE VOYAGE

- Parfaite pour les voyages ou la salle de sport, mais aussi pour un usage quotidien
- Matériau : polyester

NECESER DE VIAJE

- Perfecto para viajar o llevar al gimnasio, también es ideal para usar a diario
- Material: poliéster

REISE-KOSMETIKTASCHE

- Perfekt für Reisen oder das Fitnessstudio, ideal auch für den Alltag
- Material: Polyester

PACKAGING

cardboard belly band
L 24 x H 22.5 x W 6 cm

SOLD X 4

TOR0001



8 052461 962061



With hook

5 compartments:
3 small pockets and
2 larger pockets
with zip closure



TRAVELLER SET

L 15 x H 11 x W 4.5 cm

TRAVELLER SET

- The set includes: 1 spatula, 3 empty bottles and 2 pots which comply with airport regulations
- Includes a sheet of personalisable plastic labels
- Material: plastic, TPU

SET DA VIAGGIO

- Il set comprende: 1 spatola, 3 flaconi e 2 barattoli conformi alle norme aeroportuali
- Include un foglio di etichette plastificate personalizzabili
- Materiale: plastica, TPU

KIT DE VOYAGE

- Le kit inclut : 1 spatule, 3 flacons et 2 pots conformes aux réglementations des aéroports
- Comprend une série d'étiquettes plastifiées personnalisables
- Matériau : plastique, TPU

SET DE VIAJE

- El set incluye: 1 espátula, 3 frascos y 2 tarros conformes con las normas aeroportuarias
- Incluye un folio de etiquetas plastificadas personalizables
- Material: plástico, TPU

REISE-SET

- Das Set enthält: 1 Spatel, 3 Fläschchen und 2 Dosen, die den Flughafenbestimmungen entsprechen
- Enthält ein Blatt mit individuell gestaltbaren Kunststoff-Etiketten
- Material: Kunststoff, TPU

PACKAGING

PVC pouch
SOLD X 4

TBS0001



8 052783 614242

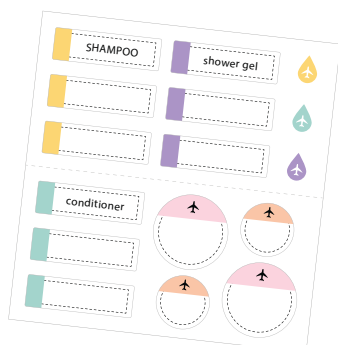

FOLDABLE BACKPACK

L 6.5 x H 8.5 cm (folded)
L 28 x H 47 cm (open)

FOLDABLE BACKPACK

- Ultra-lightweight and super-resistant
- Secure zip closure, inner pocket, adjustable straps
- Maximum weight supported: 5 kg
- Material: polyester

ZAINO PIEGHEVOLE

- Ultra leggero e super resistente
- Chiusura sicura con zip, tasca interna, cinghie regolabili
- Peso massimo supportato: 5 kg
- Materiale: poliestere

SAC-À-DOS PLIABLE

- Ultra-léger et super résistant
- Fermeture éclair sûre, poche interne, bretelles réglables
- Poids maximum supporté : 5 kg
- Matériau : polyester

MOCHILA PLEGABLE

- Ultraligera y superresistente
- Cierre seguro con cremallera, bolsillo interior, correas ajustables
- Peso máximo soportado: 5 kg
- Material: poliéster

FALTBARER RUCKSACK

- Ultraleicht und trotzdem besonders haltbar
- Mit einem Reißverschluss sicher zu verschließen, Innentasche, Verstellbare Trageriemen
- Maximales tragbares Gewicht: 5 kg
- Material: Polyester

SOLD X 4



FB0001
8 051739 309362

TRAVEL BAGS

SET OF 3 TRAVEL BAGS

- Material: polyester

SET DI 3 BUSTE DA VIAGGIO

- Materiale: poliestere

SET DE 3 SACHETS DE VOYAGE

- Matériau : polyester

SET DE 3 BOLSAS DE VIAJE

- Material: poliéster

SET MIT 3 REISETASCHEN

- Material: Polyester

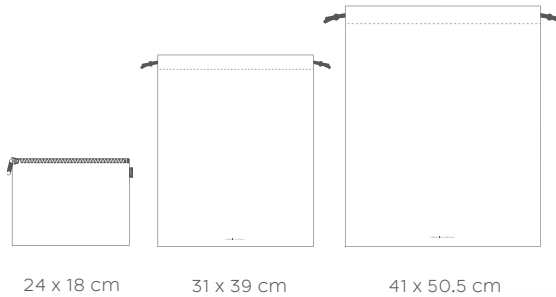

PACKAGING
cardboard belly
band w/hook
L 24 x H 21 x
W 2.5 cm
SOLD X 2



TRAVEL
POSE0001

8 052783 616055



JUNGLE
POSE0002

8 052783 616062

DIGITAL LUGGAGE WEIGHING SCALE

L 3 x H 9.8 x W 2.6 cm

DIGITAL LUGGAGE WEIGHING SCALE

- Tare function, for weighing any objects to be added to the baggage
- Measurement unit: kg/lb
- Maximum weight: 50 kg/110 lb
- Material: ABS, PC

BILANCIA DIGITALE PESA VALIGIA

- Funzione tara, per pesare eventuali oggetti da aggiungere al bagaglio
- Unità di misura: kg/lb
- Peso massimo: 50 kg/110 lb
- Materiale: ABS, PC

PÈSE-BAGAGE NUMÉRIQUE

- Fonction tare, pour peser d'éventuels objets à ajouter dans le bagage
- Unités de mesure : kg/lb
- Poids maximum : 50 kg/110 lb
- Matériau : ABS, PC

BALANZA DIGITAL PARA MALETA

- Función tara, para pesar objetos que se vayan a añadir al equipaje
- Unidades de medida: kg/lb
- Peso máximo: 50 kg/110 lb
- Material: ABS, PC

DIGITALE KOFFERWAAGE

- Tara-Funktion, um eventuelle Gegenstände, die dem Gepäck hinzugefügt werden sollen, abzuwiegen
- Maßeinheit: kg/lb
- Maximales Gewicht: 50 kg/110 lb
- Material: ABS, PC



PACKAGING:

window box
L 6 x H 17 x W 3.5 cm
SOLD X 4

DTS0001



How to use:

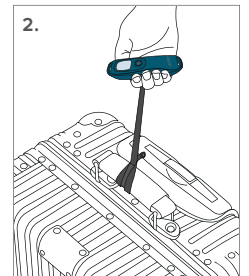
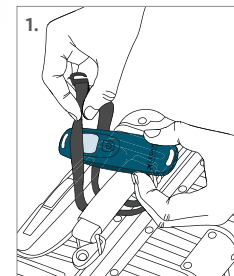

1 x CR2032 battery (included)

TRAVEL SCALE WITH TAPE MEASURE

L 9.7 x H 13 x W 3 cm

TRAVEL SCALE WITH TAPE MEASURE

- Measurement unit: kg/lb
- Maximum weight: 35 kg/80 lb
- Material: ABS,PC, steel

BILANCIA PESA VALIGIA CON METRO

- Unità di misura: kg/lb
- Peso massimo: 35 kg/80 lb
- Materiale: ABS,PC, acciaio

PÈSE-BAGAGE AVEC MÈTRE

- Unités de mesure : kg/lb
- Poids maximum : 35 kg/80 lb
- Matériau : ABS,PC, acier

PESO PARA MALETAS CON METRO

- Unidades de medida: kg/lb
- Peso máximo: 35 kg/80 lb
- Material: ABS,PC, acero

KOFFERWAAGE MIT METERMASS

- Maßeinheit: kg/lb
- Maximales Gewicht: 35 kg/80 lb
- Material: ABS,PC, Stahl



PACKAGING

window box
L 12.5 x H 18.5 x W 4.8 cm
SOLD X 4

TS0002

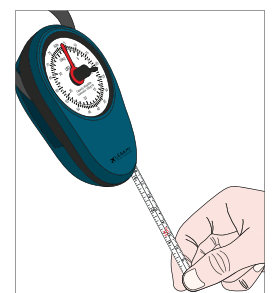
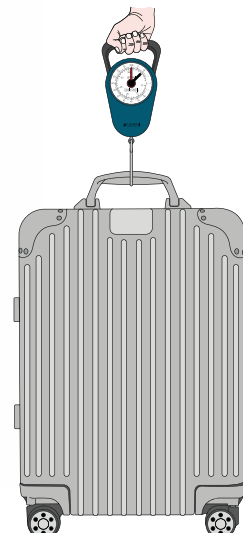

No batteries needed

MINI TRAVEL IRON

L 10 x H 3.2 x W 7.5 cm (folded)

MINI TRAVEL IRON

- Compact and light
- Power cord with Schuko plug included
- Dry iron, no water
- Material: PC, aluminium coated with non-stick Teflon paint

MINI FERRO DA STIRO DA VIAGGIO

- Compatto e leggero
- Cavo di alimentazione con spina schuko incluso
- Stira a secco, senza acqua
- Materiale: PC, alluminio rivestito con vernice teflon antiaderente

MINI FER À REPASSER DE VOYAGE

- Compact et léger
- Câble d'alimentation muni d'une prise schuko inclus
- Repassage à sec, sans eau
- Matériau : PC, aluminium revêtu d'un émail téflon antiadhésif

MINIPLANCHA DE VIAJE

- Compacta y ligera
- Cable de alimentación con enchufe Schuko incluido
- Plancha en seco, sin agua
- Material: PC, aluminio revestido con pintura teflón antiadherente

MINI-REISEBÜGELEISEN

- Kompakt und leicht
- Im Lieferumfang ist ein Netzkabel mit Schuko-Stecker enthalten
- Funktioniert ohne Wasser
- Material: PC, Aluminium mit Antihaft-Teflonlack



Temperature range:
100°C-200°C



Supply:
100-240 V ~ 50 Hz



Power:
25 W

PACKAGING

material: cardboard box
L 11.5 x H 9 x W 8 cm

SOLD X 3

T10001



8 051739 306750

Non-stick
metal plate

Power
cord input

Folding handle

1.5 m

Indicator
light

LINT-REMOVING STICKY ROLLER

L 4 x H 9.5 x W 4 cm (closed)

LINT-REMOVING STICKY ROLLER

- Contains 3 rolls of 30 sheets each
- Pre-cut easy-tear paper
- Material: plastic, adhesive paper

RULLO ADESIVO LEVA PELUCCHI

- Contiene 3 rotoli da 30 fogli cadauno
- Carta pretagliata strappo facile
- Materiale: plastica, carta adesiva

ROULEAU ADHÉSIF ANTI-PELUCHES

- Contient 3 rouleaux de 30 feuilles chacun
- Papier prédécoupé facile à détacher
- Matériau : plastique, papier adhésif

RODILLO ADHESIVO QUITA PELUSAS

- Contiene 3 rodillos de 30 hojas cada uno
- Hojas precortadas que se separan fácilmente
- Material: plástico, papel adhesivo

FUSSELROLLE

- Enthält 3 Rollen mit jeweils 30 Klebeblättern
- Vorgeschnittenes, leicht abreißbares Papier
- Material: Kunststoff, Klebepapier

PACKAGING

carded
L 12.5 x H 17 x W 6 cm
SOLD X 4

Self-standing
packaging



LB0001 AQUA



8 052783 613924

LB0002 GREY



8 052783 614174

TSA LUGGAGE PADLOCK

L 3 x H 5.8 x W 1.5 cm

TSA LUGGAGE PADLOCK

- Programmable 3-digit combination
- Material: plastic, chromed steel

LUCCHETTO TSA PER VALIGIA

- Combinazione programmabile a 3 cifre
- Materiale: plastica, acciaio cromato

CADENAS TSA POUR VALISE

- Combinaison programmable à 3 chiffres
- Matériau : plastique, acier chromé

CANDADO TSA PARA MALETA

- Combinación de 3 cifras configurable
- Material: plástico, acero cromado

TSA-SCHLOSS FÜR KOFFER

- Programmierbare 3-stellige Kombination
- Material: Kunststoff, verchromter Stahl

PACKAGING

carded
L 8.5 x H 14.5 x W 1.5 cm



DISPLAY

material: cardboard
L 20.5 x H 21 x W 13 cm

10 PCS

TSAKIT2



TRAVEL ALARM CLOCK

L 6.5 x H 2.5 x W 7 cm (closed)

ANALOG TRAVEL ALARM CLOCK

- Practical metal case
- Material: matte metal, plastic

OROLOGIO-SVEGLIA ANALOGICA DA VIAGGIO

- Pratica custodia in metallo
- Materiale: metallo opaco, plastica

HORLOGE-RÉVEIL ANALOGIQUE DE VOYAGE

- Étui métallique pratique
- Matériau : métal opaque, plastique

RELOJ-DESPERTADOR ANALÓGICO DE VIAJE

- Práctica funda en metal
- Material: metal opaco, plástico

ANALOG-REISEWECKER

- Praktisches Etui aus Metall
- Material: mattes Metall, Kunststoff

PACKAGING

cardboard box
L 7 x H 9.5 x W 3 cm
SOLD X 3

TAC001



1 x LR44 battery (included)



WORLDWIDE TRAVEL ADAPTER

L 6 x H 5.7 x W 4.6 cm

UNIVERSAL WORLDWIDE TRAVEL ADAPTER

- Compatible with more than 150 countries
- 2 USB ports for the direct charging of mobile devices such as smartphones, iPhones and tablets
- Material: ABS, brass

ADATTATORE UNIVERSALE DA VIAGGIO

- Compatibile in più di 150 paesi
- 2 porte USB per ricaricare direttamente i dispositivi mobili come smartphone, iPhone e tablet
- Materiale: ABS, ottone

CHARGEUR ADAPTATEUR DE VOYAGE UNIVERSEL

- Compatible dans plus de 150 pays
- 2 ports USB pour recharger directement les dispositifs mobiles de type smartphone, iPhone et tablette
- Matériau : ABS, laiton

ADAPTADOR DE VIAJE UNIVERSAL

- Compatible en más de 150 países
- 2 puertos USB para cargar directamente los dispositivos móviles como smartphone, iPhone y tabletas
- Material: ABS, latón

UNIVERSALER REISELADEADAPTER

- Kompatibel in mehr als 150 Ländern
- 2 USB-Anschlüsse zum direkten Aufladen von mobilen Geräten wie Smartphones, iPhones und Tablets
- Material: ABS, Messing

DISPLAY

material: cardboard
L 14 x H 16 x W 16 cm
6 PCS

TAKIT2



Function indicator light



PACKAGING

PET box w/hook
L 6.3 x H 10 x W 5 cm



Bags & Co

COLLECTION



WHAT A WALLET!



L 20 x H 10 x W 3 cm (closed)

WALLET

- Practical and safe zip closure
- External metal zip, internal plastic zip
- Material: 50% PU, 40% cotton, 10% polyester

PORTAFOGLIO

- Chiusura a cerniera pratica e sicura
- Cerniera esterna in metallo, cerniera interna in plastica
- Materiale: 50% PU, 40% cotone, 10% poliester

PORTEFEUILLE

- Fermeture éclair pratique et sûre
- Fermeture éclair extérieure en métal, fermeture interne en plastique
- Matériau : 50% PU, 40% coton, 10% polyester

MONEDERO

- Cierre de cremallera práctico y seguro
- Cremallera externa de metal y cremallera interna de plástico
- Material: 50 % PU, 40 % algodón, 10 % poliéster

GELDBÖRSE

- Öffnung mit praktischem und sicherem Reißverschluss
- Reißverschluss außen aus Metall, Reißverschluss innen aus Kunststoff
- Material: 50% PU, 40% Baumwolle, 10% Polyester

SOLD X 2

PACKAGING

FSC® certified paper envelope
L 14 x H 25 x W 4 cm



TRAVEL
WALL0001



8 052461 964256



FLOWERS
WALL0002



8 052461 964263



CACTUS
WALL0003



8 052461 964270



ESCAPE
WALL0004



8 052461 964287



TROPICAL
WALL0005



8 052461 964294



STARS
WALL0006



8 052461 964300

HOT & COLD

VACUUM BOTTLE

- Light and resistant
- Hermetic seal
- Material: double-layer stainless steel, removable silicone handle

BOTTIGLIA TERMICA

- Leggera e resistente
- Chiusura ermetica
- Materiale: acciaio inox a doppio strato, manico in silicone removibile

* While stock lasts

SOLD X 2

GOURDE THERMIQUE

- Légère et résistante
- Fermeture hermétique
- Matériau : acier inoxydable à double paroi, poignée en silicone amovible

BOTELLA TÉRMICA

- Ligera y resistente
- Cierre hermético
- Material: acero inoxidable de doble capa, asa de silicona extraíble

THERMOSFLASCHE

- Leicht und strapazierfähig
- Hermetisch dichtem Verschluss
- Material: Zweischichtiger Edelstahl, abnehmbarer Silikongriff



FOOD CONTACT PARTS
BPA AND PHTHALATE-FREE

500 ml

Ø 7 cm, H 24.5 cm

HOT & COLD BOTTLE
500 ML RANGE
2 PCS X DESIGN



8 054320 564980



AFTER RAIN
SSB0002



8 059174 832469



TRAVEL
SSB0005



8 059174 832490



CORAL
SSB0007 *



8 059174 832513



PETROL BLUE
SSB0008



8 059174 832520



BLACK
SSB0010



8 054320 563808



STARS
SSB0011



8 054320 563815



FLORA
SSB0012



8 054320 563822



DAISY
SSB0013



8 054320 563839

800 ml

NEW

Bags & Co.

Ø 8 cm, H 29.2 cm

HOT & COLD BOTTLE
800 ML RANGE
2 PCS X DESIGN



8 054320 564751



PETROL BLUE
SSBL0001



8 054320 563853



BLACK
SSBL0002



8 054320 563860



TRAVEL
SSBL0003



8 054320 563877



GOLD FOIL

STARS
SSBL0004



8 054320 563884



SILVER FOIL

FLORA
SSBL0005



8 054320 563891

DISPLAYS ON DEMAND FOR HOT&COLD 500ml

COUNTER EMPTY DISPLAY ON DEMAND

material: cardboard
L 21 x H 4 x W 31 cm (empty)
L 21 x H 26.5 x W 31 cm (full)
minimum order qty: 16 pcs

DISBOTS



8 059174 834111



FLOOR EMPTY DISPLAY ON DEMAND

material: cardboard, wooden base
L 46 x H 176 x W 39 cm
minimum order qty: 32 pcs

DISBOTM



8 059174 834128



HOT & COLD RANGE + COUNTER DISPLAY 2 PCS X DESIGN



8 054320 564300

HOT & COLD RANGE + FLOOR DISPLAY 4 PCS X DESIGN



8 054320 564317

WHAT A MASK!

CLOTH FACE MASK

- Two-ply filtration face mask. Anti-droplet treatment on both sides
- Quality fabric: comfortable, washable, reusable
- Fabric treated with Acquazero by Sitip
- Double-sided: can be used from both sides. Wash before changing side of use

MASCHERINA IN TESSUTO

- Mascherina filtrante a doppio strato. Trattamento antigocchia su entrambi i lati
- Tessuto di qualità, confortevole, lavabile, riutilizzabile
- Tessuto trattato Acquazero by Sitip
- Double face: utilizzabile da entrambi i lati. Lavare prima di cambiare lato di utilizzo

MASQUE EN TISSU

- Masque filtrant avec double couche. Traitement anti-gouttes sur les deux côtés
- Tissu de qualité, confortable, lavable, réutilisable
- Tissu traité Acquazero de Sitip
- Double-face : utilisable des deux côtés. Laver avant de changer de côté d'utilisation

MASCARILLA DE TELA

- Mascarilla filtrante de doble capa. Tratamiento antigoteo por ambos lados
- Tejido de calidad, confortable, lavable, reutilizable
- Tejido con tratamiento Acquazero de Sitip
- Reversible: puede utilizarse por ambos lados. Lavar antes de usar por el otro lado

MUNDSCHUTZ AUS STOFF

- Filtrierender Mundschutz, zweilagig. Beidseitiger Tröpfchenschutz
- Hochwertiges, angenehm zu tragendes, waschbares, wiederverwendbares Gewebe
- Gewebebehandlung mit Acquazero by Sitip
- Zweiseitiger Wende-Mundschutz: Beidseitig verwendbar. Vor der Verwendung der anderen Seite waschen

Wash before using for the first time. Can be washed up to 30 times. Tumble-drying is recommended in order to reactivate the anti-droplet treatment



EMPTY DISPLAY ON DEMAND

for adults and kids' masks
material: cardboard
L 17.5 x H 27 x W 16.5 cm
minimum order qty: 30 pcs

DISMATE



* While stock lasts

ADJUSTABLE
ELASTIC

TOP-QUALITY
FABRIC

ANTI-DROPLET
TREATMENT

REUSABLE

WASHABLE

KID SIZE

L 17 x H 11 cm



Side 1: print
82% polyester,
18% elastane



Side 2: white
82% polyester,
18% elastane



ONE SIZE FITS
5 - 12 YEAR OLDS

PACKAGING

cardboard envelope
L 13 x H 16.5 cm
SOLD X 6



Be safe...
and everything
is going to be ok!

AFTER RAIN
MABA0001 *



8 052461 964645



Be safe...
and discover!

SPACE
MABA0002



8 052461 964652



Be safe...
and cute!

PANDA
MABA0003



8 052461 964669



Be safe...
and roar!

DINO
MABA0004



8 052461 964676



Be safe...
and magical!

UNICORN
MABA0005



8 052461 964683



Be safe...
and smile!

SMILE *

MABA0006



8 052461 964690

L 24 x H 14 cm



Side 1: print
82% polyester,
18% elastane

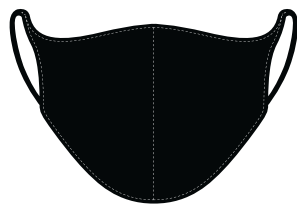

Side 2: black
80% polyamide,
20% elastane

PACKAGING
cardboard envelope
L 16 x H 19.5 cm
SOLD X 6



ONE SIZE FITS
ADULTS AND KIDS (10+)



Be safe...
and everything
is going to be ok!

AFTER RAIN
MATE0001



8 052461 964188



Be safe...
and blossom!

FLOWERS
MATE0002 *



8 052461 964195



Be safe...
and stylish!

GEOMETRIC
MATE0003



8 052461 964201



Be safe...
and wild!

JUNGLE
MATE0004 *



8 052461 964218



Be safe...
and bright!

FLASH
MATE0005



8 052461 964225



Be safe...
and shiny!

STARS
MATE0007



8 052461 965628

NOT FOR SALE IN THE UK



COIN PURSE & ZIPPER POUCH

COIN PURSE & ZIPPER POUCH

- Handy zip closure
- Material: 80% RPET, 20% polyester

PORTA MONETE & POCLETTE CON ZIP

- Pratica chiusura con cerniera zip
- Materiale: 80% RPET, 20% poliestere

PORTE-MONNAIE & POCLETTE À FERMETURE ÉCLAIR

- Fermeture éclair pratique
- Matériau : 80% RPET, 20% polyester

* While stock lasts

SOLD X 3

MONEDERO & BOLSA CON CREMALLERA

- Práctico cierre de cremallera
- Material: 80 % RPET, 20 % poliéster

GELDBÖRSE & REISSVERSCHLUSSTASCHE

- Praktischer Reißverschluss
- Material: 80% RPET, 20% Polyester



EMPTY DISPLAY ON DEMAND

material: metal
L 23 x H 51 x W 33,5 cm
minimum order qty: 66 pcs

DISFUN



8 052783 613009



COIN PURSE



TRAVEL
PURSE0013



8 051122 264131



NEWSPAPER
PURSE0014



8 051122 264148



FIESTA
PURSE0018



8 051122 264186



AIR BALLOON
PURSE0020



8 051122 264209



TO THE MOON
PURSE0021



8 051122 264216



ROBOT
PURSE0024 *



8 051122 264247



DRAMA LLAMA
PURSE0025 *



8 052783 613030



CHERRY BOMB
PURSE0026 *



8 051739 309409



PANDA
PURSE0027



8 051739 309416



TAKE IT EASY
PURSE0028



8 051739 309423



CACTUS
PURSE0029



8 051739 309430



TROPICAL DREAM
PURSE0030

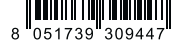

8 051739 309447



PINEAPPLES
PURSE0031



8 051739 309454



GENIUS
PURSE0032 *



8 051739 309461



AIR MAIL
POUCH0011



8 051122 264285



TRAVEL
POUCH0013



8 051122 264308



AIR BALLOON
POUCH0014



8 051122 264315



TO THE MOON
POUCH0018



8 051122 264353



CAMERA
POUCH0019



8 051122 264360



CHERRY BOMB
POUCH0024



8 051739 309478



PANDA
POUCH0025



8 051739 309485



TAKE IT EASY
POUCH0026



8 051739 309492



CACTUS
POUCH0027



8 051739 309508



TROPICAL DREAM
POUCH0028



8 051739 309515



PINEAPPLES
POUCH0029



8 051739 309522



GENIUS
POUCH0030



8 051739 309539

FIESTA & SIESTA

L 19.5 x H 2 x W 1.7 cm (closed)

FOLDING PAPER FAN

- Elastic closure
- Material: paper

VENTAGLIO IN CARTA PIEGHEVOLE

- Chiusura con elastico
- Materiale: carta

ÉVENTAIL PLIABLE EN PAPIER

- Fermeture avec élastique
- Matériau : papier

ABANICO PLEGABLE DE PAPEL

- Cierre con elástico
- Material: papel

FALTBARER PAPIERFÄCHER

- Verschluss mit Gummiband
- Material: Papierfächer

INDIVIDUAL DESIGNS: SOLD X 4

FIRST ORDER: MOQ 1 FULL ASSORTED DISPLAY (16 PCS)

material: cardboard
L 17 x H 26.5 x W 14 cm

16 PCS: 4 X DESIGN

PAPKIT2



8 051128 754636



BLOOM
PAP0002



8 052783 613702



PEACOCK
PAP0003



8 052783 613719



ALOHA
PAP0004



8 052783 613726



JUNGLE
PAP0005



8 059174 835217

FOLDING UMBRELLA

L 5 x H 23.5 x W 5 cm (closed); Ø 100 cm, H 55 cm (open)

FOLDING UMBRELLA

- Manual opening, windproof structure
- Carrying case included
- Material: polyester, black steel frame, plastic handle

OMBRELLO PIEGHEVOLE

- Apertura manuale, struttura antivento
- Custodia inclusa
- Materiale: poliester, struttura in acciaio nero, impugnatura in plastica

PARAPLUIE PLIANT

- Ouverture manuelle, structure résistante au vent
- Étui inclus
- Matériau : polyester, structure en acier noir, poignée en plastique

SOLD X 3

PARAGUAS PLEGABLE

- Apertura manual, estructura antiviento
- Funda incluida
- Material: poliéster, estructura en acero negro, mango de plástico

TASCHENSCHIRM

- Manuelle Öffnung, Anti-Wind-Struktur
- Schutzhülle inklusive
- Material: Polyester, Struktur aus schwarzem Stahl, Plastikgriff

EMPTY DISPLAY ON DEMAND

material: cardboard
L 17 x H 8 x W 17 cm (empty)
L 17 x H 24 x W 17 cm (full)
minimum order qty: 9 pcs

DISUMB



8 051128 752502



AFTER RAIN
UMB0001



8 052783 615539



TRAVEL
UMB0003



8 052783 615553

I LOVE YOU UMBRELLA

Ø 123 cm, H 93 cm (open)

HEART-SHAPED UMBRELLA

- Manual opening
- Material: polyester, black steel frame, plastic handle

OMBRELLO A FORMA DI CUORE

- Apertura manuale
- Materiale: poliester, struttura in acciaio nero, impugnatura in plastica

PARAPLUIE EN FORME DE CŒUR

- Ouverture manuelle
- Matériau : polyester, structure en acier noir, poignée en plastique

PARAGUAS EN FORMA DE CORAZÓN

- Apertura manual
- Material: poliéster, estructura de acero negro, mango de plástico

REGENSCHIRM IN HERZFORM

- Manuelle Öffnung
- Material: Polyester, Struktur aus schwarzem Stahl, Plastikgriff

SOLD X 3

UMBH0001



8 052461 961484

RAINBOW UMBRELLA

Ø 130 cm, H 105 cm (open)

UMBRELLA

- Opens up automatically
- Material: polyester, black steel frame, wooden handle

OMBRELLO

- Apertura automatica
- Materiale: poliester, struttura in acciaio nero, impugnatura in legno

PARAPLUIE

- Ouverture automatique
- Matériau : polyester, structure en acier noir, poignée en bois

PARAGUAS

- Apertura automática
- Material: poliéster, estructura en acero negro, mango de madera

REGENSCHIRM

- Automatische Öffnung
- Material: Polyester, Struktur aus schwarzem Stahl, Holzgriff

SOLD X 3

UMBMC0002



8 051739 309195

Automatic opening

EVERYDAY BAG

L 45 x H 37.5 cm (without handles)

COTTON BAG

- Handy zip closure, document/money pocket
- Material: 100% cotton, handles 100% PU

BORSA IN COTONE

- Pratica chiusura con cerniera zip, tasca porta documenti/soldi
- Materiale: 100% cotone, manici 100% PU

SAC EN COTON

- Fermeture éclair pratique, poche portemonnaie/documents
- Matériau : 100% coton, anses 100% PU

SOLD X 2

BOLSO DE ALGODÓN

- Práctico cierre de cremallera, bolsillo para documentos/dinero
- Material: 100 % algodón, asas 100 % PU

BAUMWOLLTASCHE

- Praktischer Reißverschluss, Innentasche für Dokumente/Geld
- Material: 100% Baumwolle, Griffe 100% PU

EMPTY DISPLAY ON DEMAND

material: metal
L 31,5 x H 150 x W 31,5 cm
minimum order qty: 48 pcs

DISGIF



BOOKLOVER
BAG0006



8 056304 482181



TRAVELLER
BAG0009



8 052783 613481



STARDUST
BAG0010



8 052783 613498



BANANA
BAG0012



8 052783 614099



COTTON MESH BAG

L 35 x H 65 cm (handles included)

COTTON MESH BAG

- Durable and practical
- Material: 100% cotton

BORSA A RETE IN COTONE

- Resistente e pratica
- Materiale: 100% cotone

SAC EN MAILLE DE COTON

- Résistant et pratique
- Matériau : 100% coton

BOLSA DE RED EN ALGODÓN

- Resistente y práctica
- Material: 100 % algodón

EINKAUFSNETZ AUS BAUMWOLLE

- Haltbar und praktisch
- Material: 100% Baumwolle

PACKAGING

cardboard belly band
L 15 x H 12 x W 5 cm

SOLD X 3



MAB0001 BEIGE
8 051739 307603

MAB0002 BLUE
8 051739 307610

MAB0003 CORAL
8 051739 307627

MAX 10 KG

FOLDABLE BAG

L 12 x H 12 cm (folded); L 43 x H 45.5 cm (open)

FOLDABLE BAG

- Practical, lightweight and resistant
- Material: polyester

BORSA PIEGHEVOLE

- Pratica, leggera e resistente
- Materiale: poliestere

SAC PLIABLE

- Pratique, léger et résistant
- Matériau : polyester

BOLSA PLEGABLE

- Práctica, ligera y resistente
- Material: poliéster

FALTBARE EINKAUFSTASCHE

- Praktisch, leicht und widerstandsfähig
- Material: Polyester

DISPLAY

material: cardboard
L 13 x H 17 x W 11 cm

7 PCS

FBAKIT4

8 051128 754674



MAX 20 KG

NICE TO MEET YOU

Mini

PHOTO COLLECTION

L 10.2 x H 6.5 x W 1.4 cm

CARD HOLDER

- Material: metal coated in PU with magnetic closure, soft velvet lining

PORTA CARTE

- Materiale: metallo rivestito in PU con chiusura magnetica, interno in morbido velluto

PORTE-CARTES

- Matériau : métal avec revêtement en PU et fermeture magnétique, intérieur en velours doux

* While stock lasts

SOLD X 2

TARJETERO

- Material: metal revestido en PU con cierre magnético, interior de terciopelo suave

VISITENKARTENTASCHE

- Material: Metall mit PU-Verkleidung und Magnetverschluss, innen aus weichem Samt

EMPTY DISPLAY ON DEMAND

material: cardboard
L 16 x H 18 x W 15 cm
minimum order qty: 12 pcs

DISMCHM



MCHM0015



MCHM0020



GOLD FOIL

* MCHM0027



MCHM0030



GOLD FOIL

MCHM0031



GOLD FOIL

MCHM0032



GOLD FOIL

MCHM0033



SILVER FOIL

* MCHM0034



COLOUR COLLECTION

L 10.2 x H 6.5 x W 1.4 cm

CARD HOLDER

- Material: metal coated in PU with magnetic closure, soft velvet lining

PORTA CARTE

- Materiale: metallo rivestito in PU con chiusura magnetica, interno in morbido velluto

PORTE-CARTES

- Matériau : métal avec revêtement en PU et fermeture magnétique, intérieur en velours doux

* While stock lasts

SOLD X 2

TARJETERO

- Material: metal revestido en PU con cierre magnético, interior de terciopelo suave

VISITENKARTENTASCHE

- Material: Metall mit PU-Verkleidung und Magnetverschluss, innen aus weichem Samt

EMPTY DISPLAY ON DEMAND

material: cardboard
L 16 x H 18 x W 15 cm
minimum order qty: 12 pcs

DISMCHM



MCHM0021



MCHM0022



MCHM0023



* MCHM0028



* MCHM0029



KEEP IN CONTACT

L 9 x H 3 x W 5 cm

CONTACT LENS HOLDER WITH MIRROR

- Contact lens holder (removable) inside the box
- Material: metal coated in PU with spring closure, velvet-covered interior

PORTA LENTI A CONTATTO CON SPECCHIETTO

- All'interno scatola porta lenti a contatto (removibile)
- Materiale: metallo rivestito in PU con chiusura a molla, rivestimento all'interno in velluto

ÉTUI LENTILLES DE CONTACT AVEC MIROIR

- Contient une petite boîte à lentilles de contact (amovible)
- Matériau : métal avec revêtement en PU et fermeture à ressort, revêtement intérieur en velours

ESTUCHE PARA LENTILLAS CON ESPEJO

- Contiene un portalentillas (extraíble)
- Material: metal revestido en PU con cierre de muelle, revestimiento interior de terciopelo

KONTAKTLINSENBOX MIT SPIEGEL

- Mit innerem Kontaktlinsehälter (herausnehmbar)
- Material: Metall mit PU-Verkleidung und Federverschluss, Innen mit Samt ausgekleidet

DISPLAY

material: cardboard
L 13.5 x H 16.5 x W 15 cm
8 PCS

KCKIT1



8 051128 750096



DISPLAY

material: cardboard
L 13.5 x H 16.5 x W 15 cm
8 PCS

KCKIT2



8 051128 750102



DISPLAY

material: cardboard
L 13.5 x H 16.5 x W 15 cm
8 PCS

KCKIT3



8 051128 750119



SEE YOU SOON

L 16.2 x H 6.8 x W 1.4 cm (closed)

FOLDABLE GLASSES CASE

- Magnetic clasp
- Material: PU exterior, soft velvet lining

CUSTODIA PORTAOCCIALI PIEGHEVOLE

- Chiusura magnetica
- Materiale: esterno in PU, interno in morbido velluto

ÉTUI À LUNETTES PLIABLE

- Fermeture magnétique
- Matériau : extérieur en PU, intérieur en velours doux

* While stock lasts

SOLD X 3

FUNDA PARA GAFAS PLEGABLE

- Cierre magnético
- Material: exterior de PU, interior de terciopelo suave

FALTBARES BRILLENETUI

- Magnetverschluss
- Material: außen aus PU, innen aus weichem Samt

EMPTY DISPLAY ON DEMAND

material: cardboard
L 26 x H 22.5 x W 12 cm
minimum order qty: 15 pcs

DISFGC



8 052461 965604



* FGC004



8 058093 946776



FGC005



8 058093 946783



FGC007



8 052783 617298



FGC009



8 059174 837747



FGC010



8 059174 837754



FGC011



8 059174 837761



FGC012



8 059174 837785

SECRETS BOX

Mini

MEDIUM

L 16.5 x H 3.5 x W 6 cm

GLASSES AND PEN CASE

- Material: metal coated in PU with spring closure

ASTUCCIO PORTA OCCHIALI E PENNE

- Materiale: metallo rivestito in PU con chiusura a molla

ÉTUI À LUNETTES ET STYLOS

- Matériau : métal avec revêtement en PU et fermeture à ressort

* While stock lasts

SOLD X 2

ESTUCHE PARA GAFAS Y BOLÍGRAFOS

- Material: metal revestido en PU con cierre de muelle

ETUI FÜR BRILLE UND STIFTE

- Material: Metall mit PU-Verkleidung und Federverschluss

EMPTY DISPLAY ON DEMAND

material: cardboard
L 27.5 x H 19.5 x W 19 cm
minimum order qty: 12 pcs

DISMSBM



8 057093 530350



* MSBM0042



8 055748 243273



MSBM0045



8 055748 243303



MSBM0046



8 058093 945588



MSBM0047



8 058093 945595



MSBM0048



8 058093 945601



MSBM0050



8 058093 945625



MSBM0051



8 058093 945632



MSBM0052



8 058093 945649



MSBM0055



8 058093 945670



MSBM0058



8 058093 945700



MSBM0059



8 058093 945717



MSBM0060



8 058093 945724



MSBM0061



8 052783 615867



MSBM0062



8 052783 615874

SMALL

L 9 x H 3 x W 5 cm

MINI CASE

• Material: metal coated in PU with spring closure

MINI ASTUCCIO

• Materiale: metallo rivestito in PU con chiusura a molla

MINI-ÉTUI

• Matériau : métal avec revêtement en PU et fermeture à ressort

* While stock lasts

SOLD X 2

MINI ESTUCHE

• Material: metal revestido en PU con cierre de muelle

MINI-ETUI

• Material: Metall mit PU-Verkleidung und Federverschluss

EMPTY DISPLAY ON DEMAND

material: cardboard
L 27.5 x H 19 x W 19 cm
minimum order qty: 16 pcs

DISMSBS



8 051070 279140



MSBS0070



8 051764 522842



MSBS0071



8 055748 243310



MSBS0073



8 055748 243334



MSBS0075



8 055748 243358



MSBS0076



8 055748 243365



* MSBS0077



8 055748 243372



MSBS0078



8 055748 243389



MSBS0079



8 058093 945731



MSBS0080



8 058093 945748



MSBS0082



8 058093 945762



MSBS0083



8 058093 945779



MSBS0084



8 058093 945786



MSBS0085



8 058093 945793



MSBS0087



8 058093 945816



MSBS0088



8 058093 945823



MSBS0089



8 058093 945830



MSBS0090



8 052783 615881



MSBS0091



8 052783 615898



MSBS0092



8 052783 615904



MSBS0093



8 052783 615911



MSBS0094



8 052783 615928

MY INITIAL - ADHESIVE LETTER

L MAX 2.5 x H 2.5 x W 0.2 cm

ADHESIVE METAL LETTER

- Single-use
- Material: metal, 3M adhesive

LETTERA ADESIVA IN METALLO

- Monouso
- Materiale: metallo, adesivo 3M

LETTRE ADHÉSIVE EN MÉTAL

- À usage unique
- Matériau : métal, adhésif 3M

LETRA ADHESIVA DE METAL

- Artículo de un solo uso
- Material: metal, adhesivo 3M

KLEBBUCHSTABE AUS METALL

- Einmalige Verwendung
- Material: Metall, 3M-Klebstoff

INDIVIDUAL DESIGNS: SOLD X 2

PACKAGING
carded
L 5 x H 8 cm



FIRST ORDER: MOQ 1 FULL
ASSORTED DISPLAY (120 PCS)

material: cardboard
L 20.5 x H 16 x W 15.5 cm

ASSORTMENT:

- 6 PCS: A, E, L, M, S
- 5 PCS: B, C, D, F, G, I, R, &
- HEART, STAR,
- FOUR-LEAF CLOVER
- 4 PCS: N, O, P, T, V
- 3 PCS: J
- 2 PCS: H, K, W, Z
- 1 PC: Q, U, X, Y



ILSKIT1



8 051128 752540



ILS0001



8 052783 615638



ILS0002



8 052783 615645



ILS0003



8 052783 615652



ILS0004



8 052783 615669



ILS0005



8 052783 615676



ILS0006



8 052783 615683



ILS0007



8 052783 615690



ILS0008



8 052783 615706



ILS0009



8 052783 615713



ILS0010



8 052783 615720



ILS0011



8 052783 615737



ILS0012



8 052783 615744



ILS0013



8 052783 615751



ILS0014



8 052783 615768



ILS0015



8 052783 615775



ILS0016



8 052783 615782



ILS0017



8 052783 615799



ILS0018



8 052783 615805



ILS0019



8 052783 615812



ILS0020



8 052783 615829



ILS0021



8 052783 615836



ILS0022



8 052783 615843



ILS0023



8 052783 615850



ILS0024



8 052783 616543



ILS0025



8 052783 616550



ILS0026



8 052783 616567



ILS0027



8 052783 616574



ILS0028



8 052783 616581



ILS0029



8 052783 616598



ILS0030



8 052783 616604

CUTIE

L MAX 3.2 x H MAX 2.5 x 0.2 cm

SET OF 2 METAL STICKERS

- Single-use
- Material: metal, 3M adhesive

SET DI 2 ADESIVI IN METALLO

- Monouso
- Materiale: metallo, adesivo 3M

SET DE 2 AUTOCOLLANTS EN MÉTAL

- À usage unique
- Matériau : métal, adhésif 3M

SET DE 2 ADHESIVOS DE METAL

- Artículo de un solo uso
- Material: metal, adhesivo 3M

SET AUS 2 AUFKLEBERN AUS METALL

- Einmalige Verwendung
- Material: Metall, 3M-Klebstoff



PACKAGING

carded
L 6.2 x H 11 cm



HUG ME

DISPLAY

material: cardboard
L 6.8 x H 14.6 x W 6.5 cm

10 PCS

ENAKIT1



PACKAGING

carded
L 6.2 x H 11 cm



BE HAPPY

DISPLAY

material: cardboard
L 6.8 x H 14.6 x W 6.5 cm

10 PCS

ENAKIT2



PACKAGING

carded
L 6.2 x H 11 cm



GOOD VIBES

DISPLAY

material: cardboard
L 6.8 x H 14.6 x W 6.5 cm

10 PCS

ENAKIT3



PACKAGING

carded
L 6.2 x H 11 cm



TAKE IT EASY

DISPLAY

material: cardboard
L 6.8 x H 14.6 x W 6.5 cm

10 PCS

ENAKIT4



PACKAGING

carded
L 6.2 x H 11 cm



UNICORN

DISPLAY

material: cardboard
L 6.8 x H 14.6 x W 6.5 cm

10 PCS

ENAKIT5



PACKAGING

carded
L 6.2 x H 11 cm



GRL PWR

DISPLAY

material: cardboard
L 6.8 x H 14.6 x W 6.5 cm

10 PCS

ENAKIT6



I LOVE MY BAG

L 4 x H 6.5 x W 1 cm

BAG HANGER

- Non-slip rear side
- Material: zinc

GANCIO PORTA BORSA

- Lato posteriore antiscivolo
- Materiale: zinco

CROCHET PORTE-SAC

- Côté arrière antidérapant
- Matériau : zinc

COLGADOR PARA BOLSO

- Lado posterior antideslizante
- Material: zinc

HANDTASCHENTRAGEHAKEN

- Rutschfeste Rückseite
- Material: Zink

INDIVIDUAL DESIGNS: SOLD X 5



PACKAGING
plastic bag
L 8 x H 12 cm



FIRST ORDER: MOQ 1 FULL ASSORTED DISPLAY (20 PCS)

material: cardboard
L 17.5 x H 19 x W 13 cm
20 PCS: 5 X DESIGN

HANGKIT1



8 051128 752694



HANG0001



8 052783 618721



HANG0002



8 052783 618738



HANG0003



8 052783 618745



HANG0004



8 052783 618752



MY KEY RING

L 5 x H 9 x W 0.5 cm

KEY RING

- Material: TPU, metal

PORTACHIAVI

- Materiale: TPU, metallo

PORTE-CLÉS

- Matériau : TPU, métal

LLAVERO

- Material: TPU, metal

SCHLÜSSELANHÄNGER

- Material: TPU, Metall



PACKAGING

carded
L 7 x H 11.5 x W 0.7 cm



DISPLAY

cardboard
L 7.5 x H 22 x W 20.5 cm
8 PCS

KRKIT1



8 051128 754919



LUCKY CHAIN

H MAX 8 cm (cord included)

KEY RING

- Material: zinc with silicone cord

PORTACHIAVI

- Materiale: zinco con cordino in silicone

PORTE-CLÉS

- Matériau : zinc avec cordon en silicone

SOLD X 3

LLAVERO

- Material: zinc con cuerda en silicona

SCHLÜSSELANHÄNGER

- Material: Zink mit Silikonschnur

EMPTY DISPLAY ON DEMAND

material: cardboard
L 27 x H 27 x W 19.5 cm
minimum order qty: 36 pcs

DISLUCKY2



8 056304 488886



KEY0002



8 057093 533245



KEY0003



8 057093 533252



KEY0004



8 057093 533269



KEY0006



8 057093 533283



KEY0007



8 057093 533290



KEY0012



8 057093 539674



KEY0016



8 051764 522699



KEY0021



8 055748 243426

MY INITIAL - KEY RING

H 6 cm (without hook)

KEY RING

• Material: PU, metal

PORTACHIAVI

• Materiale: PU, metallo

PORTE-CLÉS

• Matériau : PU, métal

LLAVERO

• Material: PU, metal

SCHLÜSSELANHÄNGER

• Material: PU, Metall

INDIVIDUAL DESIGNS: SOLD X 1

STARTER KIT:

50 PCS:

3 PCS: A, E, L, M, S, HEART

2 PCS: B, C, D, F, G, I, N, P, R, T, V

1 PC: H, J, K, O, Q, U, W, X, Y, Z

INKKIT1



8 051128 752564

EMPTY DISPLAY

ON DEMAND

material: cardboard

L 27 x H 27.5 x W 19.5 cm

minimum order qty: 1 starter kit

DISINK



8 052783 618103



INK0001



8 052783 616635



INK0002



8 052783 616642



INK0003



8 052783 616659



INK0004



8 052783 616666



INK0005



8 052783 616673



INK0006



8 052783 616680



INK0007



8 052783 616697



INK0008



8 052783 616703



INK0009



8 052783 616710



INK0010



8 052783 616727



INK0011



8 052783 616734



INK0012



8 052783 616741



INK0013



8 052783 616758



INK0014



8 052783 616765



INK0015



8 052783 616772



INK0016



8 052783 616789



INK0017



8 052783 616796



INK0018



8 052783 616802



INK0019



8 052783 616819



INK0020



8 052783 616826



INK0021



8 052783 616833



INK0022



8 052783 616840



INK0023



8 052783 616857



INK0024



8 052783 616864



INK0025



8 052783 616871



INK0026



8 052783 616888



INK0027



8 052783 616895

Lifestyle

COLLECTION



Mugs

COLLECTION



ESPRESSO FOR TWO

Ø 5.5 cm, H 5 cm - 50 ml

TWO NEW BONE CHINA PORCELAIN COFFEE MUGS

DUE TAZZINE DA CAFFÈ IN PORCELLANA NEW BONE CHINA

DEUX TASSES À CAFÉ EN PORCELAINE NEW BONE CHINA

DOS TAZAS DE CAFÉ EN PORCELANA NEW BONE CHINA

ZWEI ESPRESSOTASSEN AUS NEW-BONE-CHINA-PORZELLAN

PACKAGING window box L 16 x H 7 x W 7 cm **SOLD X 2**



MM0003



8 056304 482648



MM0005



8 056304 482662



MM0006



8 056304 482679



MM0007



8 056304 482686



MM0009



8 058093 946790



MM0010



8 058093 946806



MM0011



8 058093 946813



MM0013



8 052783 616611



MM0014



8 052783 616628



MM0015



8 059174 835767

COUNT YOUR LUCKY STARS



Ø 10 cm, H 9 cm - 350 ml

NEW BONE CHINA PORCELAIN MUG

TAZZA IN PORCELLANA NEW BONE CHINA

TASSE EN PORCELAINE NEW BONE CHINA

TAZA DE PORCELANA NEW BONE CHINA

NEW-BONE-CHINA-PORZELLANTASSE

PACKAGING

window box
L 15 x H 14 x W 10 cm

SOLD X 1



ARIES
CUP0001



TAURUS
CUP0002



GEMINI
CUP0003



CANCER
CUP0004



LEO
CUP0005



VIRGO
CUP0006



LIBRA
CUP0007



SCORPIO
CUP0008



SAGITTARIUS
CUP0009



CAPRICORN
CUP0010



AQUARIUS
CUP0011



PISCES
CUP0012



CUP-PUCCINO

Ø 10 cm, H 9 cm - 350 ml

NEW BONE CHINA PORCELAIN MUG

TAZZA IN PORCELLANA NEW BONE CHINA

TASSE EN PORCELAINE NEW BONE CHINA

TAZA DE PORCELANA NEW BONE CHINA

NEW-BONE-CHINA-PORZELLANTASSE

PACKAGING

window box
L 15 x H 14 x W 10 cm
SOLD X 1



TAKE A BREAK COLLECTION



CUP0013



8 051739 307917



CUP0014



8 051739 307924



CUP0015



8 051739 307931



CUP0016



8 051739 307948



CUP0017



8 051739 307955



CUP0018



8 051739 307962



CUP0019



8 051739 307979



CUP0020



8 051739 307986



CUP0021



8 051739 307993



CUP0022



8 051739 308006



CUP0023



8 051739 308013



CUP0024



8 051739 308020



CUP0035



8 052461 962139



CUP0036



8 052461 962146



CUP0037



8 052461 962153



CUP0050



8 052461 962948

BUONGIORNO COLLECTION - ITALIAN MARKET



CUP0038



8 052461 962825

WORLD CITIES COLLECTION



MILANO
CUP0025



8 051739 308037



ROMA
CUP0026



8 051739 308044



ROMA
CUP0027



8 051739 308051



FIRENZE
CUP0028



8 051739 308068



COMO
CUP0033



8 051739 308211



NAPOLI
CUP0034



8 051739 308228

TU VUÒ FÀ L'AMERICANO

Ø 10 cm, H 15 cm - 300 ml

DOUBLE-LAYER NEW BONE CHINA PORCELAIN MUG

- Keeps your drinks warm
- With soft silicone lid

TAZZA IN PORCELLANA NEW BONE CHINA A DOPPIO STRATO

- Mantiene calde le tue bevande
- Con tappo in morbido silicone

TASSE EN PORCELAINE NEW BONE CHINA À DOUBLE PAROI

- Maintient vos boissons chaudes
- Avec couvercle en silicone souple

TAZA DE PORCELANA NEW BONE CHINA CON DOBLE CAPA

- Mantiene calientes tus bebidas
- Con tapa en silicona blanda

NEW-BONE-CHINA PORZELLANTASSE MIT DOPPELTER BESCHICHTUNG

- Hält Ihre Getränke warm
- Mit Deckel aus weichem Silikon



Without silicone lid

PACKAGING

window box
L 10.3 x H 16 x W 10.3 cm

SOLD X 1



AME0001



8 051122 263653



AME0002



8 051122 263660



AME0004



8 051122 263684



AME0005



8 051122 263691



AME0008



8 051122 263721



AME0009



8 051122 263738



AME0010



8 051122 263745



AME0012



8 051122 263769



AME0013



8 051122 263776



AME0015



8 052783 617069



BUONGIORNO MUG

Ø 9 cm, H 8 cm - 350 ml

NEW BONE CHINA PORCELAIN MUG

TAZZA IN PORCELLANA NEW BONE CHINA

TASSE EN PORCELAINE NEW BONE CHINA

TAZA DE PORCELANA NEW BONE CHINA

NEW-BONE-CHINA-PORZELLANTASSE

* While stock lasts



PACKAGING

window box
L 12 x H 15 x W 9 cm

SOLD X 1



Every day
is an adventure.

MUG0062



8 056304 484765



Life is better
when you are laughing.

MUG0063



8 056304 484772



Dream big.

MUG0073 *



8 056304 484871



Booklover: (booklover) n.1. A
person devoted to reading
2. One who would rather...

MUG0074 *



8 056304 484888



Today I choose
happiness.

MUG0075



8 056304 484895

ITALIAN MARKET



Never stop dreaming.

MUG0079



8 056304 484932



Non pensate di annegare i
vostri dispiaceri nell'alcool.
Sanno nuotare.
Albert Willemetz

MUG0016



8 031301 359209



Se ami qualcuno
lascialo dormire.

MUG0047 *



8 056304 484611



Voglio bere con te il primo
caffè del mattino.

MUG0048 *



8 056304 484628



Tu riempi i miei giorni.

MUG0050



8 056304 484642



Chi legge i tuoi stessi libri ha
una mappa per la tua anima.

MUG0051



8 056304 484659



Ho un sogno e...
ti ci devo portare.

MUG0052



8 056304 484666



Scusate esattamente
quanto manca al weekend?

MUG0053



8 056304 484673



Questa storia che per
uscire bisogna togliersi il
pigiama deve finire.

MUG0054



8 056304 484680



Oggi sarà un giorno
stupendo.

MUG0055



8 056304 484697



I'm going to see
the world.
#Bergamo

MUG0056



8 056304 484703



I'm going to see
the world.
#Firenze

MUG0057 *



8 056304 484710



I'm going to see
the world.
#Verona

MUG0082



8 052783 614990



I'm going to see
the world.
#Venezia

MUG0083



8 052783 615003



I'm going to see
the world.
#Torino

MUG0084



8 052783 615010

DISPLAY ON DEMAND

EMPTY DISPLAY ON DEMAND

- 2-sided
- Material: cardboard, wooden base
- L 55 x H 162 x W 35 cm

MINIMUM ORDER QTY: 63 PCS

- Espresso for two: 18 pcs
- Cup-puccino/ Count your lucky stars: 30 pcs
- Tu vuoi fà l'americano: 15 pcs

DISMUG2



8 054320 564973



Magnets

MAGNET

L 5.5 x H 8 cm

MAGNET

- UV varnish or foil printing
- Material: paper, plastic, magnetised plastoferrite

CALAMITA

- Stampa con vernice UV o lamina
- Materiale: carta, plastica, plastoferrite magnetizzata

AIMANT

- Impression avec vernis UV ou film laminé
- Matériau : papier, plastique, plastoferrite magnétisé

* While stock lasts

SOLD X3

IMÁN

- Con motivos en barniz UV o efecto metálico
- Material: papel, plástico, imanes plásticos magnetizados

MAGNET

- Druck mit UV-Lack oder Folie
- Material: Papier, Kunststoff, magnetisierter Plastoferrit

EMPTY DISPLAY ON DEMAND

material: metal
L 23,5 x H 30 x W 16 cm
minimum order qty: 60 pcs

DISMAG



8 051070 279232

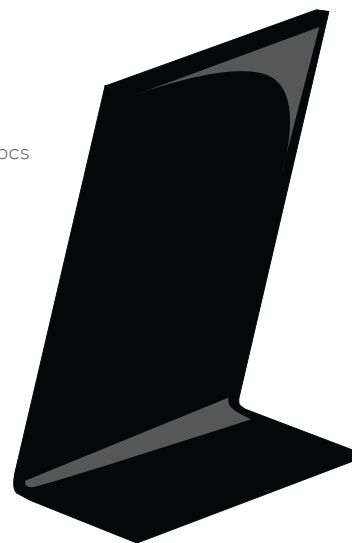

WORLD CITIES COLLECTION



BERGAMO

MAG0230



8 052783 615027



BERGAMO

MAG0260



8 052783 618370



FIRENZE

MAG0231



8 052783 615034



FIRENZE

MAG0232



8 052783 615041



FIRENZE

MAG0263



8 052783 618400



MILANO

MAG0233



8 052783 615058



MILANO

MAG0261



8 052783 618387



ROMA

MAG0234



8 052783 615065



ROMA

MAG0264



8 052783 618417



VENEZIA

MAG0235



8 052783 615072



VENEZIA

MAG0236



8 052783 615089



VENEZIA

MAG0266



8 052783 618431



VERONA

MAG0237



8 052783 615096



TORINO

MAG0262



8 052783 618394

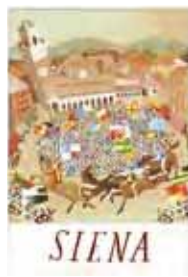

SIENA

MAG0265



8 052783 618424



COMO

MAG0267



8 051739 308914



NAPOLI

MAG0268



8 051739 309256



PARIS

MAG0238



8 052783 615225



LONDON

MAG0239



8 052783 615232



NEW YORK

MAG0240



8 052783 615249



Barcelona

MAG0241



8 052783 615256



MAG0242



8 052783 615263



MAG0243



8 052783 615270



MAG0244



8 052783 615287



MAG0245



8 052783 615294



MAG0246 *



8 052783 615300



MAG0247



8 052783 615317



MAG0248



8 052783 615324



MAG0249



8 052783 615331



MAG0250



8 052783 615348



MAG0251



8 052783 615355



MAG0252



8 052783 615362



MAG0253



8 052783 615379



MAG0254



8 052783 615386



MAG0255



8 052783 615393



MAG0256 *



8 052783 615409



MAG0257



8 052783 615416



MAG0258



8 052783 615423



MAG0259



8 052783 615430

NEVER STOP DREAMING

L 6.5 x H 6.5 cm

SET OF 3 MAGNETS

- UV varnish or foil printing
- Material: paper, plastic, magnetised plastoferrite

SET DI 3 MAGNETI

- Stampa con vernice UV o lamina
- Materiale: carta, plastica, plastoferrite magnetizzata

SET DE 3 AIMANTS

- Impression avec vernis UV ou film laminé
- Matériau : papier, plastique, plastoferrite magnétisé

* While stock lasts

SET DE 3 IMANES

- Con motivos en barniz UV o efecto metálico
- Material: papel, plástico, imanes plásticos magnetizados

SET MIT 3 MAGNETEN

- Druck mit UV-Lack oder Folie
- Material: Papier, Kunststoff, magnetisierter Plastoferrit

PACKAGING

- carded
- L 7.2 x H 24.3 cm
- SOLD X 6

MSET001 *



8 052783 613931



MAGNETIC NOTEPAD

L 9.8 x H 12.7 x W 2.5 cm

MAGNETIC NOTEPAD

- 235 tear-off sheets
- 80 g/m² paper
- Material: paper. Rigid baking card. Magnetic base

BLOCCHETTO NOTE MAGNETICO

- 235 fogli staccabili
- Carta 80 g/m²
- Materiale: carta. Supporto in cartoncino rigido. Base magnetica

BLOC-NOTES MAGNÉTIQUE

- 235 feuilles détachables
- Papier 80 g/m²
- Matériau : papier. Support en carton rigide. Base magnétique

SOLD X 6

BLOC DE NOTAS MAGNÉTICO

- 235 hojas separables
- Papel de 80 g/m²
- Material: papel. Soporte de cartón rígido. Base magnética

MAGNETISCHER NOTIZBLOCK

- 235 abtrennbare Zettel
- Papier 80 g/m²
- Material: Papier. Basis aus stabilem Karton. Magnetische Basis



MGNOT0001



8 052461 962092

SOMETHING TO REMEMBER

L MAX 29 x H MAX 30.6 cm

MAGNETIC WHITEBOARD

- Marker with safety cap conforming to toy regulations
- Material: magnetic rubber sheet

LAVAGNA MAGNETICA

- Pennarello conforme alla normativa giocattolo con tappo anti soffoco
- Materiale: foglio magnetico gommato

TABLEAU MAGNÉTIQUE

- Feutre avec bouchon anti-étouffement, conforme à la réglementation applicable aux jouets
- Matériau : feuille magnétique caoutchoutée

* While stock lasts

PIZARRA MAGNÉTICA

- Rotulador con tapón antiasfixia conforme a la normativa de juguetes
- Material: hoja magnética revestida con goma

MAGNETTAFEL

- Filzstift mit verschlucksicherem Verschluss, entspricht der Spielzeugrichtlinie
- Material: Magnetblatt mit Gummiüberzug

PACKAGING

PVC bag w/ hook

SOLD X 2



BUSY FAMILY

MBO0072



8 055748 249213



TRAVEL

MBO0081



8 058093 949944



SCHOOL BUS

MBO0076 *



8 055748 249251



FLAMINGO

MBO0082



8 058093 949951



PENGUIN

MBO0083



8 058093 949966



UNICORN

MBO0084



8 058093 949975

SOMETHING TO WRITE

L 14.8 x H 21 cm

SET OF FRIDGE MAGNETS

- The pack contains over 100 pieces, including letters, punctuation, numbers and symbols
- Material: magnetic rubber sheet

SET DI MAGNETI DA FRIGORIFERO

- Il set contiene più di 100 pezzi, incluse lettere, punteggiatura, numeri e simboli
- Materiale: foglio magnetico gommatto

SET D'AIMANTS MAGNÉTIQUES POUR FRIGO

- Le set comprend plus de 100 pièces, dont des lettres, des signes de ponctuation, des chiffres et des symboles
- Matériau : feuille magnétique caoutchoutée

SET DE IMANES PARA EL FRIGORÍFICO

- El set contiene más de 100 piezas, entre las que se incluyen letras, signos de puntuación, números y símbolos
- Material: hoja magnética revestida con goma

MAGNET-SET FÜR DEN KÜHLSCHRANK

- Das Set enthält mehr als 100 Stücke, inklusive Buchstaben, Satzzeichen, Zahlen und Symbolen
- Material: Magnetblatt mit Gummiüberzug

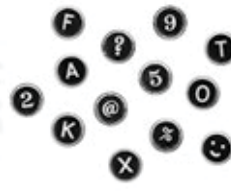
TYPEWRITER**PACKAGING**

cardboard envelope
L 16 x H 24 cm
SOLD X 6

STW0001



8 051122 265657

**AIRPORT****PACKAGING**

cardboard envelope
L 16 x H 24 cm
SOLD X 6

STW0002



8 051122 265664

**DON'T FORGET**

L 10 x H 21.5 cm

MAGNETIC NOTEPAD WITH 100 TEAR-OFF SHEETS

- Pencil included
- Two perforated lines
- Material: paper. Rigid baking card. Magnetic base

BLOC NOTES MAGNETICO CON 100 FOGLI STACCABILI

- Matita inclusa
- Doppia perforazione a strappo
- Materiale: carta. Supporto in cartoncino rigido. Base magnetica

BLOC-NOTES MAGNÉTIQUE AVEC 100 FEUILLES DÉTACHABLES

- Crayon inclus
- Double perforation, détachables
- Matériau : papier. Support en carton rigide. Base magnétique

BLOC DE NOTAS MAGNÉTICO CON 100 FOLIOS SEPARABLES

- Lápiz incluido
- Doble línea de arranque
- Material: papel. Soporte de cartón rígido. Base magnética

MAGNETNOTIZBLOCK MIT 100 ABTRENNBAREN BLÄTTERN

- Inklusive Bleistift
- Doppelte Perforation zum Abtrennen
- Material: Papier. Basis aus stabilem Karton. Magnetische Basis

* While stock lasts

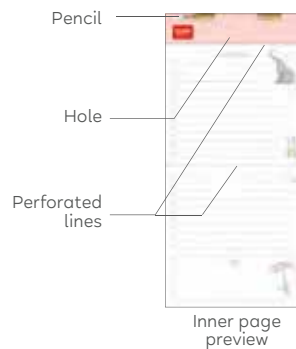
**PACKAGING**

plastic bag
L 13 x H 25.7 x W 1.3 cm
SOLD X 2



ELEPHANT
MNPO065



8 051122 260003



UNICORN
MNPO066 *



8 051122 260010

Beauty

COLLECTION



HELLO BEAUTY

L 21 x H 19 x W 17 cm (handle included)

BEAUTY CASE

- With zip closure, inside pockets and elastic brush holder straps
- Material: polyester, PU

BEAUTY CASE

- Con chiusura a zip, tasche interne e fascette elastiche porta pennelli
- Materiale: poliester, PU

TROUSSE DE MAQUILLAGE

- Avec fermeture éclair, poches internes et bandes élastiques porte-pinceaux
- Matériau : polyester, PU

NECESER

- Con cierre de cremallera, bolsillos internos y bandas elásticas portapinceles
- Material: poliéster, PU

KÖSMETIKTASCHE

- Mit Öffnung mit Reißverschluss, Innentaschen und elastischen Bändern, um Pinsel zu verstauen
- Material: Polyester, PU

SOLD X 3

PACKAGING

cardboard belly band
L 21 x H 21 x W 3 cm



CHERRY BOMB

BEB0001



8 059174 833008

FLOWER BLOOM

BEB0002



8 059174 833015

BLING QUEEN

L 13 x H 5.5 x W 9 cm

JEWELLERY BOX

- Mini size
- Zip closure
- Equipped with three compartments
- Material: PU, soft velvet inner lining

PORTAGIOIE

- Formato mini
- Chiusura a zip
- Dotato di tre scomparti
- Materiale: PU, interno foderato in morbido velluto

BOÎTE À BIJOUX

- Format mini
- Avec fermeture éclair
- Dotée de trois compartiments
- Matériau : PU, doublure intérieure en velours doux

JOYERO

- Formato mini
- Cierre con cremallera
- Dotado de tres compartimentos
- Material: PU, interior forrado de terciopelo suave

SCHMUCKKASTEN

- Miniformat
- Mit einem Reißverschluss zu öffnen
- Mit drei Fächern ausgestattet
- Material: PU, Innenfutter aus weichem Samt

SOLD X 3



SHINE BRIGHT

JEB0001



8 059174 834081

STARDUST

JEB0002



8 059174 834098

NAILS BEFORE MALES

L 2 x H 18 x W 0.3 cm

SET OF 3 NAIL FILES

- 2 sides = 2 actions: coarse-grained back for filing; fine-grained front for refining
- Material: sandpaper, EVA, PS

SET DI 3 LIME PER UNGHIE

- 2 lati = 2 azioni: retro a grana grossa per limare; fronte a grana fine per rifinire
- Materiale: carta abrasiva, EVA, PS

SET DE 3 LIMES À ONGLES

- 2 faces = 2 actions : une face recto à gros grain pour limer; une face verso à grain fin pour la finition
- Matériau : papier émeri, EVA, PS

SET DE 3 LIMAS DE UÑAS

- 2 lados = 2 acciones: lado de grano grueso para limar; lado de grano fino para pulir
- Material: papel de lija, EVA, PS

SET MIT 3 NAGELFEILEN

- 2 Seiten = 2 Funktionen: Rückseite mit grober Körnung zum Feilen; Vorderseite mit feiner Körnung zum Nachbearbeiten
- Material: Schleifpapier, EVA, PS

PACKAGING

PVC bag
L 9 x H 22.5 x W 0.4 cm
SOLD X 6



NO PROBLAMA
NFS0001



8 059174 832346



BE WILD
NFS0002



8 059174 832353

LITTLE PANDA & LITTLE MONKEY

L 8.3 x H MAX 9 x W 10.5 cm

NAIL POLISH DRYER

- Material: plastic

ASCIUGA SMALTO

- Materiale: plastica

SÈCHE VERNIS À ONGLES

- Matériau : plastique

SECADOR DE UÑAS

- Material: plástico

NAGELACKTROCKNER

- Material: Kunststoff



2 x AAA batteries
(not included)



LITTLE PANDA
NDM0001



8 058093 949586

LITTLE MONKEY
NDM0002



8 058093 949593

PACKAGING

window box
L 9 x H 12.5 x W 11 cm
SOLD X 3



BYE BYE FRIDA

L 5 x H 0.5 x W 0.6 cm

SET OF 4 MINI TWEEZERS

- 4 different tips for every need: flat tip, slant tip, pointed-slant tip, point tip
- Material: stainless steel

SET DI 4 MINI PINZETTE

- 4 punte differenti per ogni necessità: punta piatta, punta angolata, punta obliqua, punta appuntita
- Materiale: acciaio inossidabile

SET DE 4 MINI PINCES À ÉPILER

- 4 mors différents pour chaque besoin: mors plats, mors crabe, mors en biais, mors pointus
- Matériau : acier inoxydable

SET DE 4 MINI PINZAS

- 4 puntas diferentes para cada necesidad: punta plana, punta angulada, punta oblicua, punta fina
- Material: acero inoxidable

SET MIT 4 MINI-PINZETTEN

- 4 verschiedene Spitzen für jeden Bedarf: Spitze mit gerader Form, Spitze mit eckiger Form, Spitze mit schräger Form, Spitze mit spitz zulaufender Form
- Material: Edelstahl

PACKAGINGPVC bag
L 6.2 x H 16 x W 0.7 cm**SOLD X 6**

TWE0001



8 059174 831943

**BOBBY PINS**

H 5.5 cm

HAIR PINS

- Set of 20 assorted hair pins
- Material: metal

FORCINE PER CAPELLI

- Set di 20 forcine assortite per capelli
- Materiale: metallo

ÉPINGLES À CHEVEUX

- Kit de 20 épingles à cheveux assorties
- Matériau : métal

HORQUILLAS PARA EL PELO

- Set de 20 horquillas variadas para el pelo
- Material: metal

HAARNADELN

- Set aus 20 farblich sortierten Haarnadeln
- Material: Metall

DISPLAYmaterial: cardboard
L 20 x H 16 x W 10 cm**18 PCS**

PINSKIT1

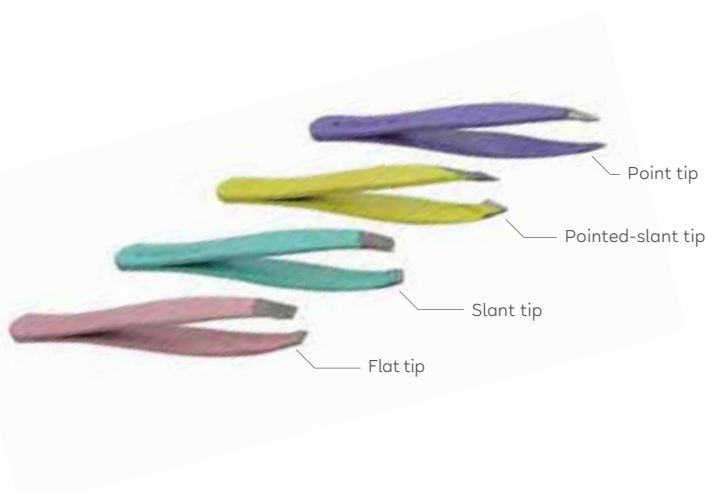

8 051128 750140

**PACKAGING**plastic jar
Ø 3 cm, H 7 cm

COLOURS:
gold pearl effect,
blue, pastel
green, pastel
pink, black pearl
effect

**LOOKIN' SHARP**

L 6.5 x H 3.7 x W 3.2 cm

CONTACT LENS CASE

- Material: polystyrene, polypropylene, ABS

PORTA LENTI A CONTATTO

- Materiale: polistirene, polipropilene, ABS

ÉTUI À LENTILLES DE CONTACT

- Matériau : polystyrène, polypropylène, ABS

PORTALENTILLAS

- Material: poliestireno, polipropileno, ABS

KONTAKTLINSENBEHÄLTER

- Material: Polystyrol, Polypropylen, ABS

PACKAGINGPET box w/hook
L 6.5 x H 6 x W 3.5 cm**DISPLAY**material: cardboard
L 14.5 x H 19.5 x W 21.5 cm**12 PCS**

CLSKIT1



8 051128 752175



HAND CREAM

Ø 6.5, H 3.5 cm - 18 ml

SCENTED HAND CREAM

- Moisturising and nourishing
- Dermatologically tested

CREMA PROFUMATA PER LE MANI

- Idratante e nutriente
- Dermatologicamente testata

CRÈME PARFUMÉE POUR LES MAINS

- Hydratante et nourrissante
- Testée sous contrôle dermatologique

CREMA PERFUMADA PARA LAS MANOS

- Hidratante y nutriente
- Dermatológicamente testada

DUFTENDE HANDCREME

- Feuchtigkeitsspendend und nährend
- Dermatologisch getestet

PACKAGING

view top box with
cardboard base
L 9 x H 9 x W 4 cm



DISPLAY

material: cardboard
L 19 x H 23 x W 19.5 cm
12 PCS

CREAMKIT1



8 051128 752151



PACKAGING

view top box with
cardboard base
L 9 x H 9 x W 4 cm



DISPLAY

material: cardboard
L 19 x H 23 x W 19.5 cm
12 PCS

CREAMKIT2



8 051128 752168



UNICORN
Magic cherry



NARWHAL
Vanilla dream

SMACK

Ø 2 cm, H 7.5 cm

NATURAL LIP BALM

- 75% natural ingredients
- Nourishing and protective

BURROCAO NATURALE

- 75% di ingredienti naturali
- Nutriente e protettivo

BAUME À LÈVRES NATUREL

- 75% d'ingrédients naturels
- Nourissant et protecteur

SOLD X 4

BÁLSAMO LABIAL NATURAL

- 75 % de ingredientes naturales
- Nutritivo y protector

NATÜRLICHER LIPPENBALSAM

- 75% natürliche Inhaltsstoffe
- Nährstoffreich und schützend



EMPTY DISPLAY

ON DEMAND
material: cardboard
L 19 x H 16.5 x W 10 cm
minimum order qty: 28 pcs

DISSMACK



8 051070 279201



RASPBERRY
SMA0001



8 051070 270673



ALOE
SMA0002



8 051070 270680



COCONUT
SMA0004



8 051070 270703



VANILLA
SMA0005



8 051070 270710



CHERRY
SMA0006



8 051070 270727



CHOCOLATE
SMA0008



8 057093 533542



STRAWBERRY
SMA0009



8 057093 533559

MAGIC KISS - UNICORN

L 4.5 x H 5.5 x W 4 cm

LIP GLOSS

LUCIDALABBRA

BRILLANT À LÈVRES

BRILLO DE LABIOS

LIPGLOSS

DISPLAY

material: plastic
L 14 x H 15.5 x W 14 cm

24 PCS

ULPINKKIT1



Cotton candy

MAGIC KISS - MERMAID

L 4 x H 5 x W 3.3 cm

LIP GLOSS

LUCIDALABBRA

BRILLANT À LÈVRES

BRILLO DE LABIOS

LIPGLOSS

DISPLAY

material: plastic
L 14 x H 15.5 x W 14 cm

24 PCS

MLGKIT1



Sweet vanilla

MAGIC KISS - CACTUS

L 5 x H 4 x W 3 cm

LIP GLOSS

LUCIDALABBRA

BRILLANT À LÈVRES

BRILLO DE LABIOS

LIPGLOSS

DISPLAY

material: plastic
L 14 x H 15.5 x W 14 cm

24 PCS

CLGKIT1



Sweet vanilla

MAGIC KISS - PANDA

L 4.2 cm x H 4.8 x W 4.2 cm

LIP BALM

• Lasting hydration

BURROCACAO

• Idratazione duratura

BAUME À LÈVRES

• Hydratation durable

BÁLSAMO LABIAL

• Hidratación duradera

LIPPENBALSAM

• Dauerhafte
Feuchtigkeitversorgung

DISPLAY

material: cardboard
L 19.5 x H 18 x W 21 cm

12 PCS

PANDAKIT2



PACKAGING

PET box w/hook
L 6 x H 7.5 x W 5 cm



Sweet vanilla



NICE TO SEE YOU

L 6 x H 6 x W 1 cm

HANDBAG MIRROR

- Two mirrors, one of which is magnifying
- Ideal for your handbag and for travelling

SPECCHIETTO DA BORSETTA

- Due specchi, uno dei quali ingranditore
- Ideale per la borsetta e per il viaggio

MIROIR DE POCHE

- Deux miroirs, l'un des deux grandissant
- Idéal à emporter dans votre sac à main et en voyage

ESPEJO DE BOLSO

- Dos espejos, uno de ellos con aumento
- Ideal para llevarlo en el bolso y para los viajes

TASCHENSPIEGEL

- Zwei Spiegel, von denen einer ein Vergrößerungsspiegel ist
- Ideal für die Handtasche und für Reisen

INDIVIDUAL DESIGNS: SOLD X 2



FIRST ORDER: MOQ 1 FULL ASSORTED DISPLAY (12 PCS)

material: cardboard
L 16 x H 13.3 x W 12 cm
12 PCS: 2 X DESIGN

MIRKIT1



8 051128 751963



FLOWERS
MIR0001



8 056304 486240



AIR BALLOON
MIR0004



8 056304 486271



PANDA
MIR0006



8 056304 486295



TRAVEL
MIR0008



8 051122 265893



UNICORN
MIR0009



8 051122 265909



CAT
MIR0010



8 051122 265916

CUTIE FRIENDS

Ø 4 cm, H 6.5 cm

MAKE-UP SPONGE

- Soft sponge for applying foundation and concealers
- Easy to use and soft to the touch
- Latex-free
- Material: PU

SPUGNETTA MAKE-UP

- Morbida spugnetta per l'applicazione di fondotinta e correttori
- Facile da utilizzare e morbida al tatto
- Priva di lattice
- Materiale: PU

ÉPONGE À MAQUILLAGE

- Éponge douce pour l'application de fonds de teint et de correcteurs
- Facile à utiliser et douce au toucher
- Sans latex
- Matériau : PU

ESPONJA DE MAQUILLAJE

- Suave esponja para la aplicación de la base de maquillaje y el corrector
- Fácil de utilizar y suave al tacto
- Sin látex
- Material: PU

MAKE-UP-SCHWAMM

- Weicher Schwamm zum Auftragen von Foundation und Concealer
- Einfach anzuwenden und mit weicher Haptik
- Latexfrei
- Material: PU

PACKAGING

PVC box w/fabric loop
L 4 x H 8 x W 4 cm

DINO



DISPLAY

material: cardboard
L 8.5 x H 17 x W 17 cm

8 PCS

BBLKIT1



8 051128 753257



PACKAGING

PVC box w/fabric loop
L 4 x H 8 x W 4 cm

LLAMA



DISPLAY

material: cardboard
L 8.5 x H 17 x W 17 cm

8 PCS

BBLKIT2



8 051128 753264



PACKAGING

PVC box w/fabric loop
L 4 x H 8 x W 4 cm

AVOCADO



DISPLAY

material: cardboard
L 8.5 x H 17 x W 17 cm

8 PCS

BBLKIT3



8 051128 753271



LOVE AT FIRST WIPE

L 6 x H 10.5 x W 2.5 cm (pack size)

10 WET WIPES

- Refreshing scented wet wipes for the hands and face in resealable packaging

10 SALVIETTINE UMIDIFICATE

- Salviettine umidificate rinfrescanti e profumate per le mani e il viso in confezione richiudibile

10 LINGETTES HUMIDES

- Lingettes humides rafraichissantes et parfumées pour les mains et le visage, dans un emballage refermable

10 TOALLITAS HÚMEDAS

- Toallitas húmedas refrescantes y perfumadas para las manos y el rostro en envase recerrable

10 FEUCHTTÜCHER

- Erfrischende und duftende Feuchttücher für Hände und Gesicht in einer wiederverschließbaren Verpackung



Aloe vera

DISPLAY

material: cardboard
L 12 x H 16.5 x W 11.5 cm

12 PCS

WIPKIT2



8 051128 751284



Sweet vanilla

DISPLAY

material: cardboard
L 12 x H 16.5 x W 11.5 cm

12 PCS

WIPKIT3



8 051128 751291



PARFUM À PORTER

Ø 2 cm, H 8.8 cm

REFILLABLE PERFUME SPRAY

- Contents: 2 refill adaptors, funnel, perfume holder
- Material: glass vial, metal lid

VAPORIZZATORE RICARICABILE PER PROFUMO

- Contiene: 2 adattatori per ricarica, imbuto, porta profumo
- Materiale: boccetta in vetro, tappo in metallo

VAPORISATEUR RECHARGEABLE POUR PARFUM

- Contient : 2 adaptateurs pour recharge, entonnoir, porte-parfum
- Matériau : flacon en verre, bouchon en métal

VAPORIZADOR DE PERFUME RECARGABLE

- Contenido: 2 adaptadores para la recarga, embudo, portaperfume
- Material: frasco de vidrio, tapón de metal

NACHFÜLLBARER PARFÜMZERSTÄUBER

- Inhalt: 2 Auffülladapter, Trichter, Parfümsprühflasche
- Material: Glasflakon, Metalldeckel



PACKAGING

PET box w/hook
L 3 x H 9 x W 3 cm

POIS



DISPLAY

material: cardboard
L 6.5 x H 16.5 x W 12.5 cm

8 PCS

RPHKIT1



8 051128 751222



PACKAGING

PET box w/hook
L 3 x H 9 x W 3 cm

HAPPINESS



DISPLAY

material: cardboard
L 6.5 x H 16.5 x W 12.5 cm

8 PCS

RPHKIT2



8 051128 751239



PACKAGING

PET box w/hook
L 3 x H 9 x W 3 cm

CATS



DISPLAY

material: cardboard
L 6.5 x H 16.5 x W 12.5 cm

8 PCS

RPHKIT3



8 051128 751246



AMAZING HAIR



L 6.8 x H MAX 11.5 x W 4.3 cm

DETANGLING HAIRBRUSH

- With flexible bristles in different heights: reduces the risk of hair damage and breakage
- Material: plastic

SPAZZOLA DISTRICANTE PER CAPELLI

- Denti flessibili, di altezze differenti: riduce il rischio di danneggiamento e rottura dei capelli
- Materiale: plastica

BROSSE DÉMÊLANTE POUR CHEVEUX

- Dents flexibles, de différentes hauteurs : elle réduit le risque d'abîmer et de casser les cheveux
- Matériau : plastique

CEPILLO PARA DESENREDAR EL CABELLO

- Dientes flexibles con diferentes alturas: reduce el riesgo de dañar y romper el cabello
- Material: plástico

ENTWIRRENDE HAARBÜRSTE

- Flexible Borsten mit unterschiedlicher Höhe: Reduziert das Risiko für geschädigtes oder brüchiges Haar
- Material: Kunststoff

PACKAGING

PVC box w/fabric loop
L 7 x H 11.5 x W 4.2 cm

SOLD X 4

UNICORN

BRU0001



8 052461 965987



PACKAGING

PVC box w/fabric loop
L 7 x H 9 x W 4.2 cm

SOLD X 4

FLORA

BRU0002



8 052461 965994



PACKAGING

PVC box w/fabric loop
L 7 x H 9 x W 4.2 cm

SOLD X 4

AVOCADO

BRU0003



8 052461 966007



NICE HAIR

W 3 cm, Ø 6.5 cm (closed)

HAIRBRUSH WITH MIRROR

SPAZZOLA CON SPECCHIO

BROSSE À CHEVEUX ET MIROIR

CEPILLO CON ESPEJO

HAARBÜRSTE MIT SPIEGEL

LILAC
PANDA



DISPLAY
material: cardboard
L 9 x H 17 x W 19 cm
4 PCS

HBKIT26



LADYBUGS



DISPLAY
material: cardboard
L 9 x H 17 x W 19 cm
4 PCS

HBKIT22



AFTER RAIN



DISPLAY
material: cardboard
L 9 x H 17 x W 19 cm
4 PCS

HBKIT27



UNICORN
RAINBOW



DISPLAY
material: cardboard
L 9 x H 17 x W 19 cm
4 PCS

HBKIT29



CAT



DISPLAY
material: cardboard
L 9 x H 17 x W 19 cm
4 PCS

HBKIT30



DONUT



DISPLAY
material: cardboard
L 9 x H 17 x W 19 cm
4 PCS

HBKIT31



UNICORN



DISPLAY
material: cardboard
L 9 x H 17 x W 19 cm
4 PCS

HBKIT32



PANDA



DISPLAY
material: cardboard
L 9 x H 17 x W 19 cm
4 PCS

HBKIT33



KOALA



DISPLAY
material: cardboard
L 9 x H 17 x W 19 cm
4 PCS

HBKIT34



CHILL OUT



Ø MAX 7.5 cm

REUSABLE COOLING EYE PADS

- 2 eye pads with a soothing effect
- Ingredients: 90.5% water, 5% glycerin, 4.5% sodium polyacrylate, glitter
- Material: PVC

DISCHETTI OCCHI RINFRESCANTI E RIUTILIZZABILI

- 2 dischetti per occhi con effetto lenitivo
- Ingredienti: 90,5% acqua, 5% glicerina, 4,5% poliacrilato di sodio, glitter
- Materiale: PVC

DISQUES RAFRAÎCHISSANTS ET RÉUTILISABLES POUR LES YEUX

- 2 disques pour les yeux avec un effet apaisant
- Ingrédients : 90,5% d'eau, 5% de glycérine, 4,5% de polyacrylate de sodium, paillettes
- Matériau : PVC

DISCOS REFRESCANTES Y REUTILIZABLES PARA OJOS

- 2 discos para ojos con efecto calmante
- Ingredientes: 90,5 % agua, 5 % glicerina, 4,5 % policacrilato de sodio, purpurina
- Material: PVC

WIEDERVERWENDBARE, ERFRISCHENDE AUGENPADS

- 2 Augenpads mit beruhigender Wirkung
- Inhaltsstoffe: 90,5% Wasser, 5% Glycerin, 4,5% Natriumpolyacrylat, Glitter
- Material: PVC

PACKAGING

PET box w/fabric loop
L 16.6 x H 8.2 x W 1 cm



PANDA



DISPLAY

material: cardboard
L 17.5 x H 14.5 x W 11.5 cm
10 PCS

EYPKIT1



8 051128 755220



PACKAGING

PET box w/fabric loop
L 16.6 x H 8.2 x W 1 cm

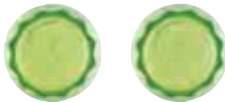

CUCUMBER



DISPLAY

material: cardboard
L 17.5 x H 14.5 x W 11.5 cm
10 PCS

EYPKIT2



8 051128 755237



PACKAGING

PET box w/fabric loop
L 16.6 x H 8.2 x W 1 cm



HEART



DISPLAY

material: cardboard
L 17.5 x H 14.5 x W 11.5 cm
10 PCS

EYPKIT3



8 051128 755244



CHILL OUT

L 19.5 x H MAX 11 cm

GEL EYE MASK

- Reusable mask with adjustable elastic
- Dual function: can be used hot or cold
- Ingredients: 70% water, 25% glycerin, 5% sodium polyacrylate
- Material: PVC, polyester

MASCHERA GEL PER OCCHI

- Maschera riutilizzabile con elastico regolabile
- Doppia funzione: sollievo caldo e sollievo freddo
- Ingredienti: 70% acqua, 25% glicerina, 5% sodio poliacrilato
- Materiale: PVC, poliester

MASQUE EN GEL POUR LES YEUX

- Masque réutilisable avec élastique réglable
- Double fonction : apaisement chaud et froid
- Ingrédients : 70% d'eau, 25% de glycérine, 5% de polyacrylate de sodium
- Matériau : PVC, polyester

ANTIFAZ DE GEL PARA LOS OJOS

- Antifaz reutilizable con elástico ajustable
- Doble función: alivio con efecto caliente y frío
- Ingredientes: 70 % agua, 25 % glicerina, 5 % poliacrilato de sodio
- Material: PVC, poliéster

GELMASKE FÜR DIE AUGEN

- Wiederverwendbare Maske mit verstellbarem Gummiband
- Doppelfunktion: warme und kalte Erleichterung
- Inhaltsstoffe: 70% Wasser, 25% Glycerin, 5% Natriumpolyacrylat
- Material: PVC, Polyester

PACKAGING

PET box
L 10.5 x H 22 x W 1.5 cm



PANDA



DISPLAY

material: cardboard
L 11.5 x H 28 x W 12.5 cm
7 PCS

EMKIT1



8 051128 752663



PACKAGING

PET box
L 10.5 x H 22 x W 1.5 cm



MEOW



DISPLAY

material: cardboard
L 11.5 x H 28 x W 12.5 cm
7 PCS

EMKIT2



8 051128 752670



PACKAGING

PET box
L 9 x H 22 x W 1.5 cm



DREAM BIG



DISPLAY

material: cardboard
L 10 x H 28 x W 12.5 cm
7 PCS

EMKIT3



8 051128 752687



NAP QUEEN

L 20,5 x H 10 x W 1 cm



SLEEP MASK

- Elastic strap that is practical, comfortable and adjustable
- Material: polyester

MASCHERINA DA NOTTE

- Elastico regolabile, pratico e comodo
- Materiale: poliestere

MASQUE DE SOMMEIL

- Sangle élastique, pratique, confortable et réglable
- Matériau : polyester

ANTIFAZ DE NOCHE

- Sujeción con elástico, práctica, cómoda y ajustable
- Material: poliéster

SCHLAFMASKE

- Elastischer, praktischer, bequemer und regulierbarer Verschluss
- Material: Polyester

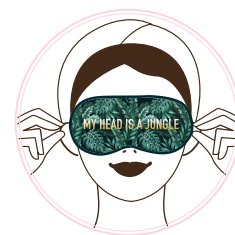
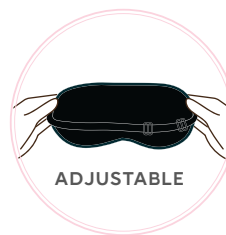

PACKAGING

window box
L 9.5 x H 23 x W 1.8 cm



DISPLAY

material: cardboard
L 11.3 x H 31 x W 15.5 cm

7 PCS

SEMKIT1



PACKAGING

window box
L 9.5 x H 23 x W 1.8 cm



DISPLAY

material: cardboard
L 11.3 x H 31 x W 15.5 cm

7 PCS

SEMKIT2



PACKAGING

window box
L 9.5 x H 23 x W 1.8 cm



DISPLAY

material: cardboard
L 11.3 x H 31 x W 15.5 cm

7 PCS

SEMKIT3



*ONE MORE DESIGN ON PAGE 32



Sos

COLLECTION



SOS CAR SWEET CAR

L MAX 6.8 x H MAX 11.5 cm



CAR FRESHENER

• Material: fragranced cardboard

PROFUMATORE PER AUTO

• Materiale: cartoncino profumato

DÉSODORISANT VOITURE

• Matériau : carton parfumé

AMBIENTADOR PARA EL COCHE

• Material: cartón perfumado

AUTO-LUFTERFRISCHER

• Material: parfümierter Karton

PACKAGING

carded
L 7.4 x H 19 cm



DISPLAY

material: cardboard
L 8 x H 22 x W 5 cm

12 PCS



HAPPINESS

Ocean

CARKIT2



8 051128 750836



DONNA AL VOLANTE

Vanilla

CARKIT4



8 051128 750850



AIR BALLOON

Strawberry

CARKIT5



8 051128 750867



UNICORN

Vanilla

CARKIT2



8 051128 751918



INHALE EXHALE

Ocean

CARKIT13



8 051128 755466



DREAM BIG

Vanilla

CARKIT14



8 051128 755473



CACTUS

On the beach

CARKIT15



8 051128 755480



FOLLOW YOUR DREAMS

Strawberry

CARKIT16



8 051128 755497



AVOCADO

On the beach

CARKIT17



8 051128 755503



PANTASTIC

Vanilla

CARKIT18



8 051128 755510

SOS NO-TOUCH KEY RING

L 9 x H 2.5 x W 0.3 cm

NO-TOUCH KEY RING

- An accessory that helps you to use objects without touching the parts potentially contaminated with germs
- Material: zinc

PORTACHIAVI NO TOUCH

- Accessorio che aiuta ad usare gli oggetti senza toccare le parti potenzialmente contaminate da germi
- Materiale: zinco

PORTE-CLÉS NO TOUCH

- Accessoire permettant d'utiliser les objets sans toucher les parties potentiellement contaminées par des germes
- Matériau : zinc

LLAVERO SIN CONTACTO

- Accesorio que ayuda a usar los objetos sin tener que tocar las partes potencialmente contaminadas por gérmenes
- Material: zinc

NO-TOUCH-SCHLÜSSELANHÄNGER

- Ein Accessoire, das hilft, Gegenstände zu benutzen, ohne die potentiell mit Keimen kontaminierten Teile mit den Händen zu berühren
- Material: Zink

PACKAGING

carded
L 16.5 x H 6 x W 0.5 cm



Touchscreen tip



DISPLAY

material: cardboard
L 11 x H 24.2 x W 15 cm
8 PCS

CKEYKIT1



- Key ring
- Grip
- Finger hole
- Door-opener hook
- Bottle-opener

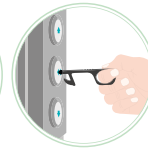

SOS POP

L 7.5 cm

BOTTLE OPENER KEY RING

- Material: metal

PORTACHIAVI APRIBOTTIGLIE

- Materiale: metallo

PORTE-CLÉS OUVRE-BOUTEILLE

- Matériau : métal

LLAVERO ABREBOTELLAS

- Material: metal

FLASCHENÖFFNER ALS SCHLÜSSELANHÄNGER

- Material: Metall

* While stock lasts

PACKAGING

carded
L 8.5 x H 15.5 x W 0.5 cm



DISPLAY

material: cardboard
L 11 x H 24 x W 15.5 cm
14 PCS

POPKIT2 *



SOS SECRET BANK

Ø 1.5 cm, L 5.5 cm

MONEY HOLDER KEY RING

- Can hold one rolled banknote
- Material: aluminium

PORTACHIAVI PORTA SOLDI

- Può contenere una banconota arrotolata
- Materiale: alluminio

PORTE-CLÉS PORTE-MONNAIE

- Peut contenir un billet roulé à l'intérieur
- Matériau : aluminium

LLAVERO PORTA DINERO

- Puede contener un billete enrollado
- Material: aluminio

SCHLÜSSELANHÄNGER FÜR EINE BANKNOTE

- Kann eine aufgerollte Banknote aufnehmen
- Material: Aluminium

PACKAGING

carded
L 7 x H 10.5 x W 0.7 cm



DISPLAY

material: cardboard
L 17 x H 17 x W 10.8 cm
10 PCS

SECKIT1



Fold your banknote, then roll and put it here



SOS MR. TICKLE

BACK SCRATCHER
• Material: metal

GRATTASCHIENA
• Materiale: metallo

GRATTE-DOS
• Matériau : métal

RASCADOR DE ESPALDA
• Material: metal

RÜCKENKRATZER
• Material: Metall

MINI BACK SCRATCHER

L 11 cm (closed)
L 25 cm (extended)

PACKAGING
carded
L 7.5 x H 15.5 x W 1.5 cm



DISPLAY
material: cardboard
L 18 x H 21 x W 10.5 cm
10 PCS

MBSKIT1
8 051128 754421

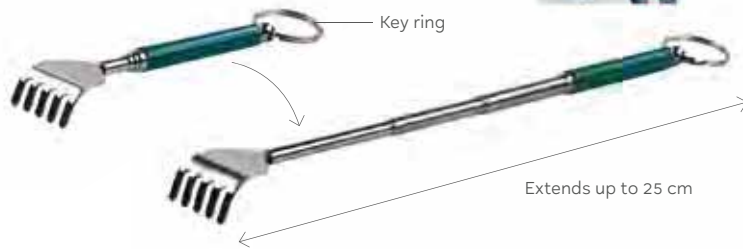

BACK SCRATCHER

L 15.5 cm (closed)
L 51 cm (extended)

PACKAGING
carded
L 8 x H 22.2 x W 1 cm



DISPLAY
material: cardboard
L 18.2 x H 29 x W 11.5 cm
10 PCS

TESCKIT1
8 051128 754896



SOS GLASSES

GLASSES REPAIR KIT

- Mini screwdriver key ring
- Material: plastic, metal

KIT RIPARA OCCHIALI

- Mini cacciavite portachiavi
- Materiale: plastica, metallo

KIT DE RÉPARATION POUR LUNETTES

- Mini tournevis porte-clés
- Matériau : plastique, métal

KIT REPARA GAFAS

- Llaveró en forma de mini destornillador
- Material: plástico, metal

BRILLEN-REPARATUR-SET

- Mini-Schraubendreher als Schlüsselanhänger
- Material: Kunststoff, Metall

PACKAGING

carded
L 7 x H 15.5 x W 1 cm



DISPLAY

material: cardboard
L 18 x H 22.5 x W 13 cm
12 PCS

EYEKIT2



6 screws and 2 nose pads

SOS STRING

L 68 cm

GLASSES CORD

- Suitable for most frames
- Material: polyamide, non-slip rubber loop

CORDINO PER OCCHIALI

- Adatto alla maggior parte delle montature
- Materiale: poliammide, passante antiscivolo in gomma

CORDON À LUNETTES

- Adapté à la plupart des montures
- Matériau : polyamide, passant antiglisse en caoutchouc

CORDÓN PARA GAFAS

- Se adapta a la mayoría de las monturas
- Material: poliamida, enganche antideslizante de goma

BRILLENBAND

- Für die meisten Brillengestelle geeignet
- Material: Polyamid, rutschfeste Gummischlaufe

INDIVIDUAL COLOURS: SOLD X 5

PACKAGING

carded
L 8 x H 16.5 cm



FIRST ORDER: MOQ 1 FULL ASSORTED DISPLAY (15 PCS)

material: cardboard
L 10 x H 27.5 x W 21 cm
15 PCS: 5 X COLOUR

ERKIT1



SOS LOOK AT ME

L 19 x H 15 cm (open); L 5 x H 5.5 cm (closed)

LENS CLEANING CLOTH

- Ideal for cleaning glasses and all types of screens
- Material: polyamide, polyester

PANNO PULIZIA LENTI

- Ideali per pulire occhiali e tutti i tipi di schermi
- Materiale: poliammide, poliester

CHIFFON DE NETTOYAGE LENTILLE OPTIQUE

- Idéal pour nettoyer vos lunettes et tout type d'écrans
- Matériau : polyamide, polyester

PAÑO PARA LIMPIAR LENTES

- Idóneas para limpiar gafas y todo tipo de pantallas
- Material: poliamida, poliéster

REINIGUNGSTUCH FÜR LINSEN

- Ideal zur Reinigung von Brillen und allen Arten von Bildschirmen
- Material: Polyamid, Polyester



DISPLAY

material: cardboard
L 22.5 x H 13.5 x W 16.8 cm
40 PCS: 4 X DESIGN

LOOKKITS

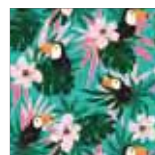

SOS SCREEN CLEANER

L 15 x H 13 cm

PRE-MOISTENED WIPES

- 12 individually-wrapped wipes
- Ideal for cleaning glasses and all types of screen

SALVIETTINE PRE-IMBEVUTE

- 12 salviettine confezionate singolarmente
- Ideali per pulire occhiali e tutti i tipi di schermi

LINGETTES NETTOYANTES PRÉ-HUMIDIFIÉES

- 12 lingettes avec sachet individuel
- Idéales pour nettoyer vos lunettes et tout type d'écrans

TOALLITAS HÚMEDAS

- 12 toallitas envasadas individualmente
- Idóneas para limpiar gafas y todo tipo de pantallas

VORGETRÄNKTE TÜCHER

- 12 einzeln verpackte Tücher
- Ideal zur Reinigung von Brillen und allen Arten von Bildschirmen

PACKAGING

cardboard box
L 6 x H 5.3 x W 4.5 cm



Individually-wrapped

DISPLAY

material: cardboard
L 12.5 x H 21 x W 19 cm

16 PCS

SCLKIT1



8 051128 750768



SOS MONEY

L 14 x H 8.5 x W 0.5 cm (closed)

SPENDING TRACKER NOTEBOOK

- PVC wallet for storing receipts and/or bills
- Material: 90 g/m² paper

TACCUINO NOTA SPESE

- Bustina in PVC per conservare ricevute e/o scontrini
- Materiale: carta 90 g/m²

CARNET DE DÉPENSES

- Pochette en PVC pour conserver les reçus et/ou les tickets de caisse
- Matériau : papier 90 g/m²

CUADERNO PARA ANOTAR GASTOS

- Sobrecito de PVC para guardar recibos y/o tickets
- Material: papel de 90 g/m²

AUSGABEN-NOTIZBUCH

- PVC-Umschlag zum Aufbewahren von Quittungen und/oder Kassenbelegen
- Material: Papier 90 g/m²

PACKAGING

PVC pouch
L 15 x H 9.8 x W 0.5 cm



66 pages

DISPLAY

material: cardboard
L 15.5 x H 16.5 x W 10.3 cm

15 PCS

MCBKIT1



8 051128 750294



SOS PASSWORD BOOK

L 8.2 x H 5 x W 0.4 cm (closed)

BOOKLET FOR ORGANISING USERNAMES AND PASSWORDS

- 9 sheets to keep up to 36 accounts
- Material: paper, magnetic cover

LIBRICINO PER ORGANIZZARE USERNAME E PASSWORD

- 9 fogli per custodire fino a 36 account
- Materiale: carta, copertina magnetica

CARNET POUR NOTER LES IDENTIFIANTS ET LES MOTS DE PASSE

- 9 feuilles pour ranger jusqu'à 36 comptes
- Matériau : papier, couverture magnétique

CUADERNILLO PARA ORGANIZAR NOMBRES DE USUARIO Y CONTRASEÑAS

- 9 folios para guardar hasta 36 cuentas
- Material: papel, tapa magnética

BÜCHLEIN ZUR ORGANISATION VON BENUTZERNAMEN UND PASSWÖRTERN

- 9 Blätter, um bis zu 36 Accounts aufzubewahren
- Material: Papier, Magnet-Cover

PACKAGING

carded
L 11 x H 13 x W 0.4 cm



DISPLAY

material: cardboard
L 12.5 x H 23 x W 18.5 cm

15 PCS

PSWKIT1



8 051128 750287



HAND CLEANSING GEL

L 4 x H 13 x W 3 cm (carabiner included) – 30 ml

HAND CLEANSING GEL

GEL DETERGENTE MANI

GEL NETTOYANT POUR LES MAINS

GEL LIMPIADOR DE MANOS

REINIGENDES HANDGEL



Equipped with a metal carabiner



62% alcohol

Non-sticky

With emollient pearls

No need to rinse

Instant and effective



TRAVEL

Ocean breeze

DISPLAY

material: cardboard box
L 14.5 x H 16 x W 13 cm

12 PCS

HSKIT1



8 051128 754469



FLORA

Flower power

DISPLAY

material: cardboard box
L 14.5 x H 16 x W 13 cm

12 PCS

HSKIT2



8 051128 754476



HAND CLEANSING GEL



L 5.3 x H 11.7 x W 3 cm – 100 ml

HAND CLEANSING GEL

GEL DETERGENTE MANI

GEL NETTOYANT POUR LES MAINS

GEL LIMPIADOR DE MANOS

REINIGENDES HANDGEL



70% alcohol

Non-sticky

With jojoba pearls

No need to rinse

Instant and effective



DISPLAY

material: cardboard box
L 11.5 x H 12 x W 12.5 cm

8 PCS

HSKIT3



8 051128 755589

TRAVEL

Fresh feel



DISPLAY

material: cardboard box
L 11.5 x H 12 x W 12.5 cm

8 PCS

HSKIT4



8 051128 755596

DAISY

Fresh feel



SOS FEEL BETTER

Ø 15 cm, H 6 cm - 350 ml

FABRIC ICE BAG

- Practical screw cap with hermetic seal
- Material: cotton and polyester, internal fabric with PVC coating

BORSA DEL GHIACCIO IN TESSUTO

- Pratico tappo a vite con chiusura ermetica
- Materiale: cotone e poliestere, tessuto interno con rivestimento in PVC

POCHE À GLACE EN TISSU

- Bouchon à vis pratique avec fermeture hermétique
- Matériau : coton et polyester, tissu interne avec revêtement en PVC

BOLSA DE HIELO DE TELA

- Práctico tapón de rosca con cierre hermético
- Material: algodón y poliéster, tejido interior con revestimiento en PVC

EISTASCHE AUS STOFF

- Praktischer, hermetischer Schraubverschluss
- Material: Baumwolle und Polyester, Innenfutter mit PVC-Überzug

PACKAGING

window box
L 11.2 x H 11 x W 11.2 cm
SOLD X 3



TRAVEL
IB0001



8 051122 263868



PANDA
IB0002



8 051122 263875



PENGUIN
IB0003



8 051122 263882

SOS 7-DAYS

L 10 x H 1.6 x W 3 cm

PILL BOX

- 7 different compartments, one for each day of the week
- Material: chrome-plated stainless metal, ABS

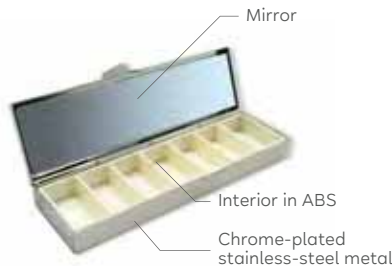

PORTA PILLOLE

- 7 diversi scomparti, uno per ogni giorno della settimana
- Materiale: metallo inossidabile cromato, ABS

PILULIER

- 7 compartiments séparés, un pour chaque jour de la semaine
- Matériau : métal inoxydable chromé, ABS

PASTILLERO

- 7 compartimentos distintos, uno para cada día de la semana
- Material: metal inoxidable cromado, ABS

PILLEDOSE

- 7 verschiedene Fächer, eins für jeden Wochentag
- Material: Verchromtes, rostfreies Metall, ABS



PIANO

DISPLAY

material: cardboard
L 10.5 x H 19 x W 13.5 cm
8 PCS

PILLKIT3



8 054320 564782



TRAVEL

DISPLAY

material: cardboard
L 10.5 x H 19 x W 13.5 cm
8 PCS

PILLKIT10



8 051128 755572



LOVE

DISPLAY

material: cardboard
L 10.5 x H 19 x W 13.5 cm
8 PCS

PILLKIT11



8 054320 564805



APOTHECARY

DISPLAY

material: cardboard
L 10.5 x H 19 x W 13.5 cm
8 PCS

PILLKIT12



8 051128 755534



STARDUST

DISPLAY

material: cardboard
L 10.5 x H 19 x W 13.5 cm
8 PCS

PILLKIT13



8 054320 564799



SOS RAIN

L 128 x H 130 cm

DISPOSABLE RAIN PONCHO WITH HOOD
 • Material: PE

PONCHO IMPERMEABILE USA E GETTA CON CAPPUCCIO
 • Materiale: PE

PONCHO DE PLUIE IMPERMÉABLE À CAPUCHE JETABLE
 • Matériau : PE

PONCHO IMPERMEABLE DESECHABLE CON CAPUCHA
 • Material: PE

EINWEG-REGENPONCHO MIT KAPUZE
 • Material: PE

PACKAGING
 plastic bag w/hook
 L 7 x H 11.5 x W 1.5 cm



DISPLAY
 material: cardboard
 L 22 x H 18.5 x W 14 cm
18 PCS

PONCHOKIT1



SOS SANPEI

Ø 25.5 cm, H 12.5 cm

FOLDABLE RAIN HAT
 • One size fits all
 • Material: nylon

CAPPELLO ANTIPIOGGIA PIEGHEVOLE
 • Taglia unica
 • Materiale: nylon

CHAPEAU DE PLUIE PLIABLE
 • Taille unique
 • Matériau : nylon

GORRO IMPERMEABLE PLEGABLE
 • Talla única
 • Material: nylon

FALTBARER REGENHUT
 • Einheitsgröße
 • Material: Nylon

INDIVIDUAL COLOURS: SOLD X 7

PACKAGING
 plastic bag
 L 12 x H 16 x W 1.5 cm



FIRST ORDER: MOQ 1 FULL ASSORTED DISPLAY (14 PCS)

material: cardboard
 L 26.5 x H 25.5 x W 17 cm
14 PCS: 7 X COLOUR

HATKIT2



SOS MR. PHONE

L 5.6 x H 52 cm

SILICONE NECK PHONE HOLDER
 • Removable strap and adjustable
 • Material: silicone, metal

PORTA CELLULARE DA COLLO IN SILICONE
 • Cordino removibile e regolabile
 • Materiale: silicone, metallo

SUPPORT TOUR DE COU EN SILICONE POUR TÉLÉPHONE PORTABLE
 • Tour de cou amovible et réglable
 • Matériau : silicone, métal

SOPORTE DE MÓVIL PARA CUELLO EN SILICONA
 • Cordón extraíble y regulable
 • Material: silicona, metal

HANDYKETTE AUS SILIKON
 • Entfernbare und verstellbare Band
 • Material: Silikon, Metall

SOLD X 6

With double metal hook

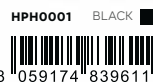

PACKAGING
 cardboard box
 L 9 x H 15 x 2.5 W cm



Stand & grip function

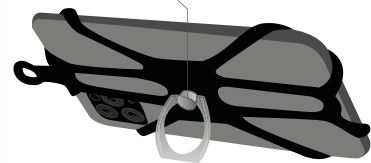

SOS WINTER

L MAX 9.5 x H MAX 10 cm

HAND WARMER

- Reusable
- Material: polyester, PE

SCALDAMANI

- Riutilizzabile
- Materiale: poliester, PE

CHAUFFE-MAINS

- Réutilisable
- Matériau : polyester, PE

CALENTADOR DE MANOS

- Reutilizable
- Material: poliéster, PE

HANDWÄRMER

- Wiederverwendbar
- Material: Polyester, PE

* While stock lasts



1.

Press the metal piece until a "click" is felt.

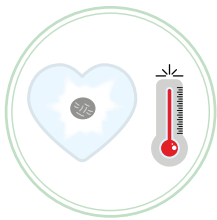

2.

The hand warmer will rapidly heat up. It will remain warm for approx. 30 minutes.

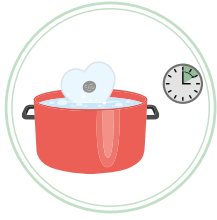

3.

To reuse it, place the hand warmer in boiling water for approx. 5 to 10 minutes.

PACKAGING

PET box w/hook
L 8.4 x H 16 x W 1.7 cm



EMERGENCY

DISPLAY

material: cardboard
L 10 x H 19.5 x W 11.5 cm
7 PCS

WARMKIT2 *



PACKAGING

PET box w/hook
L 8.4 x H 16 x W 1.7 cm



HUG ME

DISPLAY

material: cardboard
L 10 x H 19.5 x W 11.5 cm
7 PCS

WARMKIT3 *



PACKAGING

PET box w/hook
L 8.4 x H 16 x W 1.7 cm



TRAVEL

DISPLAY

material: cardboard
L 10 x H 19.5 x W 11.5 cm
7 PCS

WARMKIT6 *



PACKAGING

PET box w/hook
L 8.4 x H 16 x W 1.7 cm



ELEPHANT

DISPLAY

material: cardboard
L 10 x H 19.5 x W 11.5 cm
7 PCS

WARMKIT7 *



PACKAGING

PET box w/hook
L 9.5 x H 13.3 x W 1.7 cm



PANDA

DISPLAY

material: cardboard
L 10 x H 17.5 x W 11.5 cm
7 PCS

WARMKIT8



PACKAGING

PET box w/hook
L 9.5 x H 14.8 x W 1.7 cm



PENGUIN

DISPLAY

material: cardboard
L 10 x H 19.5 x W 11.5 cm
7 PCS

WARMKIT9



PACKAGING

PET box w/hook
L 9.5 x H 13.3 x W 1.7 cm



RAINBOW

DISPLAY

material: cardboard
L 10 x H 17.5 x W 11.5 cm
7 PCS

WARMKIT10



PACKAGING

PET box w/hook
L 9.5 x H 13.3 x W 1.7 cm



HEART

DISPLAY

material: cardboard
L 10 x H 17.5 x W 11.5 cm
7 PCS

WARMKIT11



SOS SUPERPEN

Ø 1.2, H 9.7 cm

MINI MULTIFUNCTION PEN

- Material: steel, aluminium

MINI PENNA MULTIFUNZIONE

- Materiale: acciaio, alluminio

MINI STYLO MULTIFONCTION

- Matériau : acier, aluminium

MINIBOLÍGRAFO MULTIFUNCIÓN

- Material: acero, aluminio

MINI-MULTIFUNKTIONSSTIFT

- Material: Stahl, Aluminium



PACKAGING

carded
L 8 x H 17 x W 1.4 cm



DISPLAY

material: cardboard
L 10 x H 26.5 x W 17 cm
10 PCS

PEMKTITI

8 051128 754964



Key ring

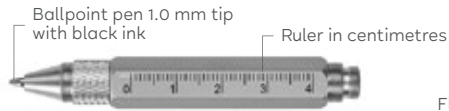

Ballpoint pen 1.0 mm tip with black ink

Ruler in centimetres

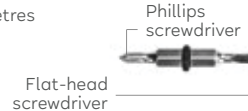

Phillips screwdriver

Flat-head screwdriver



Touchscreen rubber tip

SOS MR. 007

L 3 x H 5 x W 0.8 cm (closed)

7-IN-1 MULTI-TOOL

- Nickel-free key ring
- Material: metal

MULTIFUNZIONE 7 IN 1

- Portachiavi nickel free
- Materiale: metallo

MULTI-OUTIL 7-EN-1

- Porte-clés sans nickel
- Matériau : métal

MULTIHERRAMIENTA 7 EN 1

- Llavero sin níquel
- Material: metal

MULTIFUNKTIONSWERKZEUG 7 IN 1

- Nickelfreier Schlüsselanhänger
- Material: Metall

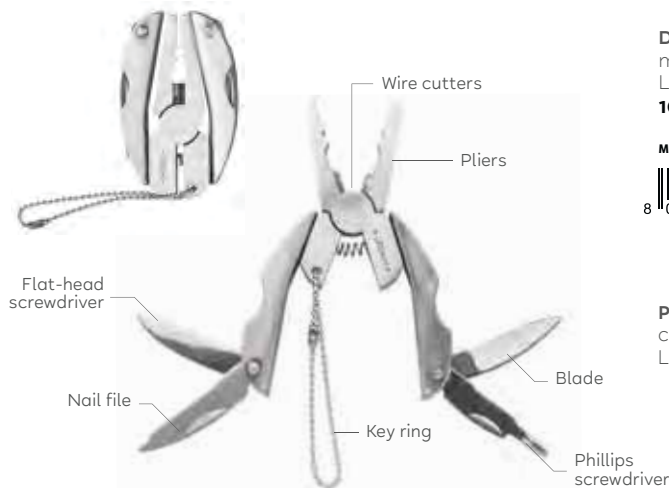

Wire cutters

Pliers

Flat-head screwdriver

Nail file

Blade

Key ring

Phillips screwdriver

DISPLAY

material: cardboard
L 12.5 x H 19.5 x W 12.8 cm
10 PCS

MULTKITI

8 051128 750553



PACKAGING

carded
L 10 x H 12 x W 1 cm



SOS I WILL SURVIVE

L 2.5 x H 9 cm (closed)

11-IN-1 MULTI-TOOL

- For recreational use only, not suitable for contact with food
- Material: ABS plastic handle, steel accessories

MULTIFUNZIONE 11 IN 1

- Solo per uso hobbistico, non adatto al contatto con alimenti
- Materiale: manico in plastica ABS, accessori in acciaio

MULTI-OUTIL 11-EN-1

- Adapté uniquement à des fins récréatives, ne convient pas au contact avec des aliments
- Matériau : manche en plastique ABS, accessoires en acier

MULTIHERRAMIENTA 11 EN 1

- Solo para uso lúdico, no apto para el contacto con alimentos
- Material: mango de plástico ABS, accesorios de acero

MULTIFUNKTIONSWERKZEUG 11 IN 1

- Nur zur Hobby-Anwendung, nicht für den Kontakt mit Lebensmitteln geeignet
- Material: Griff aus ABS-Kunststoff, Accessoires aus Stahl



Screwdriver

Can opener

Nail file

Awl

Corkscrew

Scissors

Saw

Bottle opener

Blade

DISPLAY

material: cardboard
L 11.5 x H 15 x W 13.8 cm
12 PCS

KNIFKITI

8 051128 750980



PACKAGING

cardboard box
L 10 x H 2.5 x W 3 cm



SOS MR. BIT

Ø 1.5 cm, H 11 cm

SCREWDRIVER

- Magnetic precision head and 8 interchangeable bits
- Material: metal, aluminium

CACCIAVITE

- Testa magnetica di precisione e 8 punte intercambiabili
- Materiale: metallo, alluminio

TOURNEVIS

- Support magnétique de précision et 8 pointes interchangeables
- Matériau : métal, aluminium

DESTORNILLADOR

- Cabezal magnético de precisión y 8 puntas intercambiables
- Material: metal, aluminio

SCHRAUBENDREHER

- Magnetischer Präzisionskopf und 8 auswechselbare Spitzen
- Material: Metall, Aluminium

PACKAGING

carded
L 7.5 x H 16.5 x W 2 cm





DISPLAY

material: cardboard
L 20 x H 24 x W 13.5 cm
12 PCS

SCWKIT3



Chrome vanadium bits

-  3 Phillips-heads
-  3 Flat-heads
-  2 Torx-heads



SOS MR. CARPENTER

L 7 x H 20 x W 2 cm

6-IN-1 MULTIFUNCTION HAMMER

- The handle contains 4 screwdrivers: 2 flat-head and 2 Phillips
- Material: steel

MARTELLLO MULTIFUNZIONE 6 IN 1

- Il manico contiene 4 cacciaviti: 2 a punta piatta e 2 a croce Phillips
- Materiale: acciaio

MARTEAU MULTIFONCTION 6-EN-1

- Le manche contient 4 tournevis : 2 à pointe plate et 2 cruciformes
- Matériau : acier

MARTILLO MULTIFUNCIÓN 6 EN 1

- El mango contiene 4 destornilladores: 2 de punta plana y 2 Phillips
- Material: acero

6-IN-1-MULTIFUNKTIONSHAMMER



- Der Griff enthält vier Schraubenzieher: zwei Schlitz- und zwei Kreuz-Schraubenzieher
- Material: Stahl

PACKAGING

carded
L 10 x H 26.5 x W 2.2 cm
SOLD X 6

HAMM0001



-  2 Phillips screwdrivers
-  2 flat-head screwdrivers

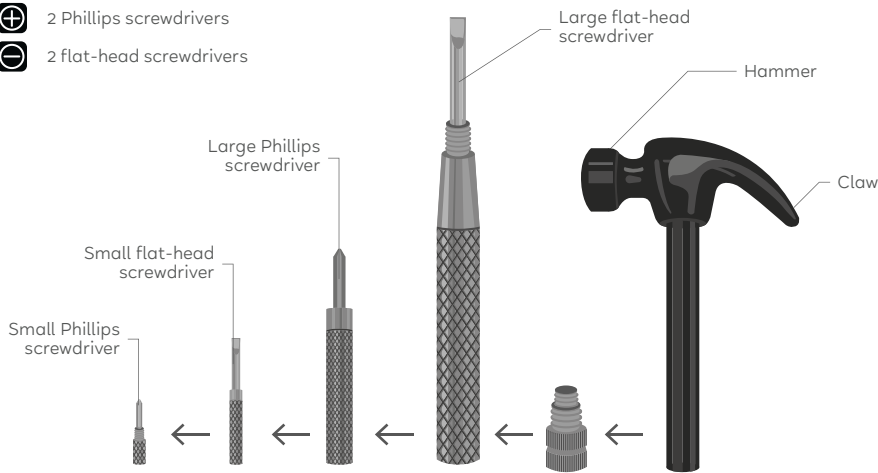

SOS MR. SIZE

L 23 x H 1.6 x W 3.6 cm (folded)

FOLDING RULER

- Extension: up to 200 cm / 78"
- 10 folds
- Double graduation in inches and centimetres
- Material: birch wood, iron hinges with engraved graduation

METRO PIEGHEVOLE

- Estensione: fino a 200 cm / 78"
- 10 pieghe
- Doppia misurazione: centimetri e pollici
- Materiale: legno di betulla, giunzioni in ferro con graduazione incisa

MÈTRE PLIANT

- Extension : jusqu'à 200 cm / 78"
- 10 segments
- Double mesure : centimètres et pouces
- Matériau : bois de bouleau, articulations en fer avec graduation gravée

METRO PLEGABLE

- Extensión: hasta 200 cm / 78"
- 10 pliegues
- Doble medida: centímetros y pulgadas
- Material: madera de abedul, uniones de hierro con escala grabada

KLAPPBARER METERSTAB

- Länge: bis zu 200 cm / 78"
- 10 Klappteile
- Zwei Maßeinheiten: Zentimeter und Zoll
- Material: Birkenholz, Gelenke aus Eisen mit eingepprägter Maßeinteilung



PACKAGING:

cardboard wrap
L 3.8 x H 25.8 x W 1.6 cm

SOLD X 6

WFR0001



SOS MR. SIZE

L 4.5 x H 4.5 x W 1.2 cm

RETRACTABLE TAPE MEASURE

- Double graduation in inches and centimetres
- Extension: up to 200 cm / 80"
- Material: PVC tape measure, ABS case

METRO RETRATTILE

- Doppia graduazione in pollici e centimetri
- Estensione: fino a 200 cm / 80"
- Materiale: metro in PVC, cassa in ABS

MÈTRE RÉTRACTABLE

- Double graduation en pouces et en centimètres
- Extension : jusqu'à 200 cm / 80"
- Matériau : mètre en PVC, boîtier en ABS

CINTA MÉTRICA RETRACTÍL

- Doble graduación, en pulgadas y centímetros
- Extensión: hasta 200 cm / 80"
- Material: metro en PVC, carcasa de ABS

ROLLMASSBAND

- Doppelmaßeinteilung in Zoll und Zentimeter
- Länge: bis zu 200 cm / 80"
- Material: Maßband aus PVC, Kapsel aus ABS

PACKAGING
carded
L 8 x H 14.4 x W 1.2 cm



DISPLAY

material: cardboard
L 8.5 x H 25 x W 20 cm

12 PCS

TMKIT2



Retraction button



Key chain

SOS MR. LIGHT

Ø 1.6 cm, H 12 cm

LED TORCH WITH MAGNETIC BASE AND MOUNTING CLIP

- Material: metal

TORCIA LED CON BASE MAGNETICA E CLIP DI FISSAGGIO

- Materiale: metallo

TORCHE À LED À BASE MAGNÉTIQUE ET CLIP DE FIXATION

- Matériau : métal

LINTERNA LED CON BASE MAGNÉTICA Y CLIP DE FIJACIÓN

- Material: metal

LED-TASCHENLAMPE MIT MAGNETBASIS UND BEFESTIGUNGS-CLIP

- Material: Metall

INDIVIDUAL COLOURS: SOLD X 6

PACKAGING
carded
L 9.5 x H 17 x W 2.5 cm



FIRST ORDER: MOQ 1 FULL ASSORTED DISPLAY (12 PCS)

material: cardboard
L 22 x H 25.5 x W 16 cm

12 PCS: 6 X COLOUR

MFKIT1



45 lumen
COB LED lighting

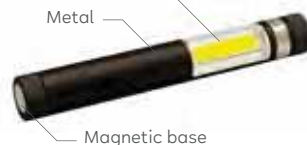

Metal

Magnetic base



1 x AAA battery
(included)

MF0001

RED



MF0002

BLACK



LIGHT MY FIRE

L 2.3 x H 6.8 x W 1 cm

RECHARGEABLE ELECTRIC LIGHTER

• Material: plastic, metal

ACCENDINO ELETTRICO RICARICABILE

• Materiale: plastica, metallo

BRIQUET ÉLECTRIQUE RECHARGEABLES

• Matériau : plastique, métal

MECHERO ELÉCTRICOS RECARGABLES

• Material: plástico, metal

WIEDERAUFLADBARES ELEKTRISCHE FEUERZEUG

• Material: Kunststoff, Metall



DISPLAY

material: cardboard
L 12 x H 15 x W 12 cm
50 PCS: 10 X DESIGN

LIGH0025



SI CHIAMA PIETRO



L 2.3 x H 6.8 x W 1 cm

ACCENDINO ELETTRICO RICARICABILE

• Materiale: plastica, metallo



DISPLAY

material: cardboard
L 12 x H 15 x W 12 cm
50 PCS: 10 X DESIGN

LIGH0034



LET THE WIND BLOW

L 2.7 x H 8 x W 1.2 cm

WINDPROOF LIGHTER

• Material: plastic, metal

ACCENDINO ANTIVENTO

• Materiale: plastica, metallo

BRIQUET ANTI-VENT

• Matériau : plastique, métal

MECHERO ANTIVIENTO

• Material: plástico, metal

WINDGESCHÜTZTES FEUERZEUG

• Material: Kunststoff, Metall



DISPLAY

material: cardboard
L 13.5 x H 15 x W 12.8 cm
50 PCS: 10 X DESIGN

BLKIT2



Wind Proof

NO SMOKING

L 7 x H 9 x W 1.5 cm (closed)

CIGARETTE CASE

• Material: tin, rubber coating

PORTASIGARETTE

• Materiale: latta, rivestimento in gomma

ÉTUI À CIGARETTES

• Matériau : fer-blanc, revêtement en caoutchouc

PITILLERA

• Material: hojalata, revestimiento en goma

ZIGARETTENETUI

• Material: Blech, Gummibeschichtung

* While stock lasts

INDIVIDUAL DESIGNS: SOLD X 2



FIRST ORDER: MOQ 1 FULL ASSORTED DISPLAY (8 PCS) + REFILL (8 PCS)

material: cardboard
L 18 x H 17.5 x W 12 cm

16 PCS: 2 X NOS0026, NOS0027, NOS0028, NOS0029, NOS0030, NOS0031, NOS0032, NOS0033

NOSKIT1



TO THE MOON

NOS0026 *



LADYBUGS

NOS0028 *



MEOW

NOS0029 *



UNICORN

NOS0031 *



ELEPHANT

NOS0032 *



SHAKE YOUR BUTTS

Ø 7 cm, H 12 cm

PUSH-BUTTON ASHTRAY

• Material: tin, plastic

POSACENERE CON PULSANTE

• Materiale: latta, plastica

CENDRIER À POUSSOIR

• Matériau : fer-blanc, plastique

CENICERO CON PULSADOR

• Material: hojalata, plástico

ASCHENBECHER MIT DRUCKKNOPF

• Material: Blech, Kunststoff



TRAVEL

DISPLAY

material: cardboard
L 8 x H 20 x W 22 cm

3 PCS

WASKIT1



8 051128 752618



JUNGLE

DISPLAY

material: cardboard
L 8 x H 20 x W 22 cm

3 PCS

WASKIT2



8 051128 752625



SLOTH

DISPLAY

material: cardboard
L 8 x H 20 x W 22 cm

3 PCS

WASKIT3



8 051128 752632

TAKE ME AWAY

L 6 x H 8.8 cm

POCKET ASHTRAY

• Outer material: PVC; internal material: heat-resistant aluminium foil

POSACENERE DA TASCHINO

• Materiale esterno: PVC; materiale interno: foglio in alluminio resistente al calore

CENDRIER DE POCHE

• Matériau extérieur : PVC; matériau intérieur : feuille en aluminium résistante à la chaleur

CENICERO DE BOLSILLO

• Material externo: PVC; material interno: capa de aluminio resistente al calor

ASCHENBECHER FÜR DIE TASCH

• Außenmaterial: PVC; Innenmaterial: wärmebeständige Aluminiumfolie



GO LEFT

DISPLAY

material: cardboard
L 9 x H 17 x W 17.5 cm

12 PCS

PASHKIT4



8 051128 755541



TRAVEL

DISPLAY

material: cardboard
L 9 x H 17 x W 17.5 cm

12 PCS

PASHKIT4



8 051128 755558



CHERRY

DISPLAY

material: cardboard
L 9 x H 17 x W 17.5 cm

12 PCS

PASHKIT20



8 051128 755657



LLAMA

DISPLAY

material: cardboard
L 9 x H 17 x W 17.5 cm

12 PCS

PASHKIT21



8 051128 755664



NO SMOKING

L 6 x H 9.5 x W 2.5 cm

CIGARETTE PACKET HOLDER

• Material: tin

PORTA PACCHETTO DI SIGARETTE

• Materiale: latta

ÉTUI POUR PAQUETS DE CIGARETTES

• Matériau : fer-blanc

✳ While stock lasts

INDIVIDUAL DESIGNS: SOLD X 3

PORTA-PAQUETE DE CIGARROS

• Material: hojalata

ETUI FÜR ZIGARETTENSCHACHTEL

• Material: Blech



FIRST ORDER: MOQ 1 FULL ASSORTED DISPLAY (12 PCS)

material: cardboard
L 21 x H 18 x W 14.5 cm

12 PCS: 3 X DESIGN

NOSPKIT1



8 051128 750881



BOAT
NOSP0015



8 056304 489838



TRAVEL
NOSP0016 ✳



8 056304 489845



AFTER RAIN
NOSP0017



8 056304 489852



CAT
NOSP0018 ✳



8 056304 489869

Hti-Tech

COLLECTION



MINI NIGHT DREAM

L 3.5 x H 1.6 x W 2.8 cm

LED READING LIGHT

- Reading lamp with two bulbs
- Material: ABS, stainless steel

LUCE LED DA LETTURA

- Luce da lettura con due lampadine
- Materiale: ABS, acciaio inox

LAMPE DE LECTURE À LED

- Lampe de lecture avec deux ampoules
- Matériau : ABS, acier inox

LUZ LED DE LECTURA

- Luz de lectura con dos bombillas
- Material: ABS, acero inoxidable

LED-LESELICHT

- Leselicht mit zwei Glühbirnen
- Material: ABS, Edelstahl



PACKAGING

carded
L 7.5 x H 12 cm



DISPLAY

material: cardboard
L 8.5 x H 21.5 x W 19 cm

10 PCS

LEDKIT1



8 051128 750935



2 x CR2025
batteries (included)



Stainless
steel clip

MICRO NIGHT DREAM

L 4.2 x H 3.5 x W 3.5 cm

LED GLASSES LIGHT

- Material: plastic

LUCE LED PER OCCHIALI

- Materiale: plastica

LAMPE À LED POUR LUNETTES

- Matériau : plastique

LUZ LED PARA GAFAS

- Material: plástico

LED-LICHT FÜR BRILLE

- Material: Kunststoff

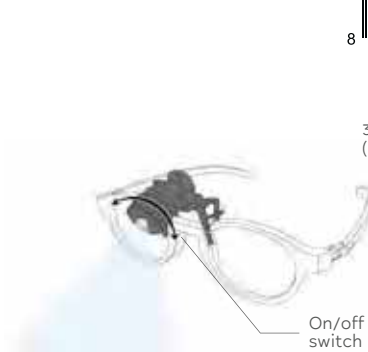

On/off
switch

PACKAGING

carded
L 7.3 x H 11.8 cm



DISPLAY

material: cardboard
L 18 x H 19 x W 14.5 cm

8 PCS

MNLKIT1



8 051128 751765



3 x LR41 batteries
(included)

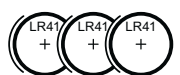

SMART NIGHT DREAM

L 13 x W 2 cm

ORIENTABLE LED READING LIGHT

- With practical clip
- Cold white LED light
- Material: ABS, metal

LUCE LED DA LETTURA ORIENTABILE

- Con pratica clip di aggancio
- Luce led bianco freddo
- Materiale: ABS, metallo

LAMPE DE LECTURE À LED ORIENTABLE

- Avec un clip d'accrochage pratique
- Lumière LED blanche froide
- Matériau : ABS, métal

LUZ LED DE LECTURA ORIENTABLE

- Incluye un práctico clip de enganche
- Luz led de color blanco frío
- Material: ABS, metal

EINSTELLBARES LED-LESELICHT

- Mit praktischem Einhak-Clip
- Kaltes weißes LED-Licht
- Material: ABS, Metall



2 x LR1130
batteries (included)



PACKAGING

carded
L 7.5 x H 17 cm



DISPLAY

material: cardboard
L 19 x H 24.5 x
W 13 cm

10 PCS

ABLKIT1



8 051128 752076



NIGHT DREAM

Ø 2.75 cm, H 23 cm



RECHARGEABLE READING LAMP WITH LED LIGHT

- Can be recharged from any USB port
- Material: plastic

LAMPADA DA LETTURA RICARICABILE CON ILLUMINAZIONE A LED

- Si ricarica da qualsiasi porta USB
- Materiale: plastica

LAMPE DE LECTURE RECHARGEABLE AVEC ILLUMINATION À LED

- Se recharge depuis n'importe quel port USB
- Matériau : plastique

LÁMPARA DE LECTURA RECARGABLE CON ILUMINACIÓN LED

- Recarga con cualquier puerto USB
- Material: plástico

WIEDERAUFLADBARE LESELAMPE MIT LED-BELEUCHTUNG

- Lässt sich über jeden USB-Anschluss aufladen
- Material: Kunststoff

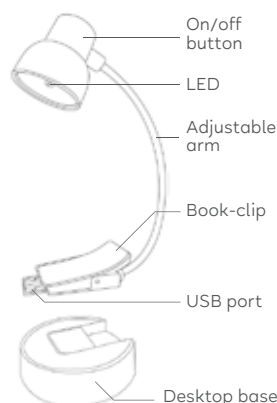

LED0003



8 051764 528073



PACKAGING

cardboard box
L 11.5 x H 18 x W 4 cm
SOLD X 3



WARM IT UP

L MAX 10 x H MAX 10 cm

USB MUG WARMER

- Ideal for mugs or glasses with a flat bottom
- Compatible with all USB ports (PC and Mac)
- Material: vinyl

SCALDA TAZZA USB

- Ideale per tazze o bicchieri con fondo piatto
- Compatibile con tutte le porte USB (PC e Mac)
- Materiale: vinile

CHAUFFE-TASSES USB

- Idéal pour les tasses ou les verres à fond plat
- Compatible avec tous les ports USB (PC et Mac)
- Matériau : vinyle

CALIENTA TAZA USB

- Ideal para tazas o vasos con fondo plano
- Compatible con todos los puertos USB (PC y Mac)
- Material: vinilo

USB-TASSENWÄRMER

- Ideal für Tassen oder Gläser mit flachem Boden
- Mit allen USB-Ports (PC und Mac) kompatibel
- Material: Vinyl

PACKAGING

window box
L 15 x H 15.5 x W 2.5 cm
SOLD X 3



No batteries needed



PANDA
WIU0001



8 051122 263790



VINYL
WIU0002



8 051122 263806



COOKIE
WIU0003



8 051122 263813



BOOKLOVER
WIU0004



8 051122 263820



CAT
WIU0006



8 052783 616536

BLOW AWAY

L 16 x H 8 x W 5.5 cm (MB0002)
L 10.5 x H 9 x W 4 cm (MB0003)

MINI USB BLOWER

- Connects directly to any USB port
- Useful for cleaning keyboards, monitors, PC fans and the general area surrounding a PC
- Material: plastic

MINI SOFFIATORE USB

- Si collega direttamente ad una qualsiasi presa USB
- Utile per la pulizia di tastiere, monitor, ventole PC ed in generale l'area intorno al PC
- Materiale: plastica

MINI SOUFFLEUR USB

- À brancher directement à une prise USB
- Idéal pour nettoyer les claviers, les écrans, les ventilateurs d'ordinateur et en général la zone autour de l'ordinateur
- Matériau : plastique

MINISOPLADOR USB

- Se conecta directamente a cualquier toma de USB
- Útil para la limpieza de teclados, monitores, ventiladores de ordenadores y el área del ordenador en general
- Material: plástico

MINI-USB-GEBLÄSE

- Lässt sich direkt mit jedem USB-Anschluss verbinden
- Nützlich für die Reinigung von Tastaturen, monitoren, PC-Lüftern und allgemein für den Bereich um den Computer
- Material: Kunststoff



For Windows and Mac



Cable length: 150 cm



No batteries needed

PACKAGING

cardboard box
L 15 x H 10.5 x W 5.5 cm
SOLD X 4

MB0002



8 052783 613627



PACKAGING

cardboard box
L 9.8 x H 14 x W 4.5 cm
SOLD X 4

MB0003



8 051739 306767



NEAT 'N CLEAN

L 14 x H 5.5 x W 4.5 cm

MINI USB VACUUM CLEANER

- Connects directly to any USB port
- Useful for cleaning keyboards and the general area surrounding a PC
- Includes 2 accessories: a brush and a flexible rubber nozzle
- Material: plastic

MINI ASPIRAPOLVERE USB

- Si collega direttamente ad una qualsiasi presa USB
- Utile per la pulizia di tastiere ed in generale l'area intorno al PC
- Include 2 accessori: spazzolina e bocchetta in gomma flessibile
- Materiale: plastica

MINI ASPIRATEUR USB

- À brancher directement à n'importe quel port USB
- Idéal pour nettoyer les claviers et en général la zone tout autour de l'ordinateur
- 2 accessoires inclus : brosse et buse flexible en caoutchouc
- Matériau : plastique

MINI ASPIRADORA USB

- Se conecta directamente a cualquier toma USB
- Útil para la limpieza de teclados y el área del ordenador en general
- Incluye 2 accesorios: mini cepillo y boquilla de goma flexible
- Material: plástico

MINI-STAUBSAUGER MIT USB-ANSCHLUSS

- Lässt sich direkt mit jedem USB-Anschluss verbinden
- Nützlich für die Reinigung von Tastaturen und allgemein für den Bereich um den Computer
- Inklusive 2 Accessoires: Bürstchen und Saugaufsatz aus flexiblem Gummi
- Material: Kunststoff



For Windows and Mac



Cable length: 150 cm



No batteries needed



PACKAGING

cardboard box
L 15 x H 9.5 x W 5.2 cm
SOLD X 4

MVC0001



8 051122 263837



MINI USB HUB

L 12.2 x H 2.2 x W 2.8 cm

4-PORT USB HUB

- Compatible with USB 1.0/1.1/2.0
- Connects up to 4 devices at the same time
- Material: plastic

HUB USB A 4 PORTE

- Compatibile con USB 1.0/1.1/2.0
- Connetti fino a 4 periferiche contemporaneamente
- Materiale: plastica

HUB USB À 4 PORTS

- Compatible avec USB 1.0/1.1/2.0
- Connectez jusqu'à 4 périphériques simultanément
- Matériau : plastique

HUB USB CON 4 PUERTOS

- Compatible con USB 1.0/1.1/2.0
- Conecta hasta 4 periféricos a la vez
- Material: plástico

USB-HUB MIT 4 PORTS

- Kompatibel mit USB 1.0/1.1/2.0
- Schließen Sie bis zu 4 Peripheriegeräte gleichzeitig an
- Material: Kunststoff



For Windows 7/8/10 and macOS



Cable length: 56 cm

PACKAGING

PET box w/hook
L 13.7 x H 5.7 x
W 3 cm

SOLD X 5



BLACK
MUA0001



8 058093 949609



WHITE
MUA0002



8 058093 949616

TOUCH ME

Ø 1 cm, L 5.5 cm

MINI TOUCHSCREEN PEN

- Compatible with all touchscreen devices
- Material: metal

MINI PENNINO TOUCH

- Compatibile con tutti i dispositivi touch screen
- Materiale: metallo

MINI STYLET TOUCH

- Compatible avec tous les dispositifs à écran tactile
- Matériau : métal

MINI LÁPIZ TÁCTIL

- Apto para todo tipo de pantallas táctiles
- Material: metal

MINI-TOUCH-STIFT

- Kompatibel mit allen Touchscreen-Bildschirmen
- Material: Metall

* While stock lasts

PACKAGING

carded
L 6.5 x H 12 x W 1 cm



DISPLAY

material: cardboard
L 16 x H 17 x W 8 cm
12 PCS: 3 X COLOUR

TOUKIT2 *



8 051128 751628

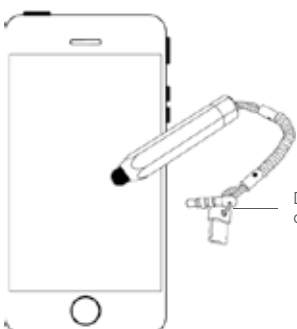

Dust-proof plug and Lightning adaptor



MAGNETIC CLIP

L MAX 4.8 x H MAX 3.3 x W 1 cm (closed)

MAGNETIC CLIP

- Ideal for keeping your cables tidy
- Material: silicone, magnet

CLIP MAGNETICA

- Ideale per tenere i cavi ordinati
- Materiale: silicone, magnete

CLIP MAGNÉTIQUE

- Idéal pour garder les câbles ordonnés
- Matériau : silicone, aimant

CLIP MAGNÉTICO

- Ideal para mantener los cables ordenados
- Material: silicona, imán

MAGNETISCHER CLIP

- Ideal, um Kabel zu ordnen
- Material: Silikon, Magnet

PACKAGING

carded
L 9 x H 12 cm x W 1 cm



HEART



DISPLAY

material: cardboard
10.6 x H 16.8 x W 8.4 cm
6 PCS

CATYHEAKIT1



PACKAGING

carded
L 9 x H 12 cm x W 1 cm



AVOCADO



DISPLAY

material: cardboard
10.6 x H 16.8 x W 8.4 cm
6 PCS

CATYAVOKIT2



PACKAGING

carded
L 9 x H 12 cm x W 1 cm



RAINBOW



DISPLAY

material: cardboard
10.6 x H 16.8 x W 8.4 cm
6 PCS

CATYRNBKIT3



PACKAGING

carded
L 9 x H 12 cm x W 1 cm



CACTUS



DISPLAY

material: cardboard
10.6 x H 16.8 x W 8.4 cm
6 PCS

CATYCAKIT4

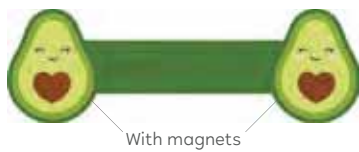

With magnets



CABLE TIES

L 18 x H 2 cm

SET OF 6 CABLE TIES

- Material: velcro

SET DI 6 FASCETTE STRINGICAVO

- Materiale: velcro

SET DE 6 ATTACHE-CÂBLES

- Matériau : Velcro

SET DE 6 BRIDAS PARA SUJETAR CABLES

- Material: velcro

SET AUS 6 KABELBINDERN

- Material: Klettverschluss

PACKAGING
carded
L 8 x H 13 x W 2.1 cm



DISPLAY
material: cardboard
L 20.5 x H 22 x W 17 cm
12 PCS

VEKIT1
8 051128 750492



CABLE HOLDERS

W 1.6 cm, Ø 2.8 cm - L 8.1 x H 2 x W 1.3 cm

SET OF 6 ADHESIVE CABLE HOLDERS

- Material: TPR rubber, 3M adhesive

SET DI 6 FERMACAVI ADESIVI

- Materiale: gomma TPR, adesivo 3M

SET DE 6 SERRE-CÂBLES ADHÉSIFS

- Matériau : caoutchouc TPR, adhésif 3M

SET DE 6 SUJETACABLES ADHESIVOS

- Material: goma TPR, adhesivo 3M

SET MIT 6 SELBSTKLEBENDEN KABELKLEMMEN

- Material: TPR-Gummi, 3M-Klebstoff

INDIVIDUAL COLOURS: SOLD X 5



PACKAGING
carded
L 10 x H 18 cm

CC0001 BLACK ■
8 052783 614105



PACKAGING
carded
L 10 x H 18 cm

CC0002 WHITE □
8 052783 614112

FIRST ORDER: MOQ 1 FULL ASSORTED DISPLAY (10 PCS)

material: cardboard
L 12.8 x H 28.5 x W 21 cm
10 PCS: 5 X COLOUR

CCKIT1
8 051128 752298



TWIST

L 3 x H 4.5 x W 0.5 cm



EARPHONE WINDER

- Perfect for winding your earphone wires
- Material: silicone

AVVOLGICAVO PER CUFFIE

- Ideale per avvolgere facilmente le cuffie audio
- Materiale: silicone

ENROULEUR DE CÂBLE POUR ÉCOUTEURS

- Idéal pour enrouler facilement les écouteurs
- Matériau : silicone

ENROLLA CABLE PARA AURICULARES

- Ideal para enrollar fácilmente el cable de los auriculares
- Material: silicona

KOPFHÖRERKABEL-AUFWICKLER

- Ideal für ein leichtes Aufwickeln von Kopfhörerkabeln
- Material: Silikon

PACKAGING
carded
L 7.5 x H 10.5 x W 0.7 cm



DISPLAY
material: cardboard
L 17 x H 17 x W 12 cm
20 PCS: 4 X COLOUR

TWKIT2
8 051128 751215



AQUA ■



LILAC ■



MAGENTA ■



BLUE ■



BLACK ■

HANDS UP



L 3.8 x H 6 x W 6 cm

MAGNETIC CAR PHONE HOLDER

- Excellent hold
- Maximum weight supported: 300 grams
- For smartphones, GPS and other electronic devices
- Material: plastic, magnet, aluminium

SUPPORTO CELLULARE DA AUTO MAGNETICO

- Ottima tenuta
- Peso massimo supportato: 300 grammi
- Per smartphone, GPS e altri dispositivi elettronici
- Materiale: plastica, magnete, alluminio

SUPPORT MAGNÉTIQUE DE VOITURE POUR TÉLÉPHONE MOBILE

- Un excellent maintien
- Poids maximum supporté : 300 grammes
- Pour smartphones, GPS et autres dispositifs électroniques
- Matériau : plastique, aimant, aluminium

SOPORTE DE MÓVIL MAGNÉTICO PARA COCHE

- Óptima fijación
- Peso máximo soportado: 300 gramos
- Para smartphones, GPS y otros dispositivos electrónicos
- Material: plástico, imán, aluminio

MAGNETISCHE TELEFONHALTERUNG FÜR DAS AUTO

- Optimaler Halt
- Maximale Belastung: 300 Gramm
- Für Smartphones, GPS und andere elektronische Geräte
- Material: Kunststoff, Magnet, Aluminium

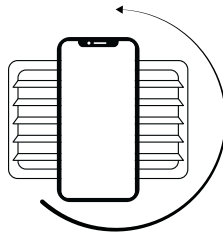

360° rotation

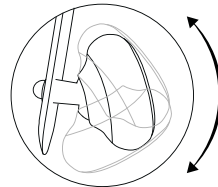

Adjustable tilt

PACKAGING

carded
L 11.5 x H 15 x W 4 cm

SOLD X 4

MCPH0002



8 052461 969770



The packaging contains



1x
Round adhesive
metal plate



1x
Rectangular
metal plate



1x
Instructions

HANDS UP

L 6.5 x H 8 x W 2.5 cm

AIR VENT CAR PHONE HOLDER

- Can be adjusted by 360 degrees
- For smartphones, GPS and other electronic devices
- Material: ABS, rubber coating

SUPPORTO PORTA CELLULARE DA AUTO PER FILTRO ARIA

- Regolabile a 360 gradi
- Per smartphone, GPS e altri dispositivi elettronici
- Materiale: ABS, rivestimento in gomma

SUPPORT TÉLÉPHONE VOITURE POUR GRILLE D'AÉRATION

- Réglable à 360 degrés
- Pour smartphones, GPS et autres dispositifs électroniques
- Matériau : ABS, revêtement en caoutchouc

SOPORTE DE TELÉFONO MÓVIL PARA RANURAS DE VENTILACIÓN DEL COCHE

- Se puede regular con un giro de 360 grados
- Para smartphones, GPS y otros dispositivos electrónicos
- Material: ABS, revestimiento en goma

TELEFONHALTERUNG FÜR DEN LUFTFILTER IM AUTO

- 360-Grad-einstellbar
- Für Smartphones, GPS und andere elektronische Geräte
- Material: ABS, Gummibeschichtung

PACKAGING

carded
L 10.5 x H 20 x W 2.8 cm

DISPLAY

material: cardboard
L 25.5 x H 27.5 x W 13 cm

8 PCS

CPHKIT1



8 051128 751253



360° rotation

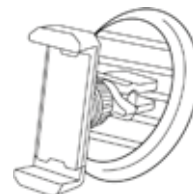

Compatible with most car air vents



Extends up to 8.9 cm wide

HOLD ME UP

L 2.5 x H 7.3 x W 0.3 cm

2 IN 1 STAND FOR MOBILE PHONE

- Improves the grip of the phone
- Material: ABS, polyester, adhesive

SUPPORTO PER CELLULARE 2 IN 1

- Migliora l'impugnatura del telefono
- Materiale: ABS, poliestere, adesivo

SUPPORT POUR TÉLÉPHONE PORTABLE 2 EN 1

- Il améliore la prise du téléphone
- Matériau : ABS, polyester, adhésif

SOPORTE PARA MÓVIL 2 EN 1

- Mejora el agarre del teléfono
- Material: ABS, polyéster, adhesivo

HANDYHALTERUNG 2 IN 1

- Sie verbessert den Griff des Telefons
- Material: ABS, Polyester, Klebstoff

PACKAGING
carded
L 8.3 x H 13.8 cm



DISPLAY
material: cardboard
L 18.5 x H 19 x W 10 cm
12 PCS

STRAPKIT2

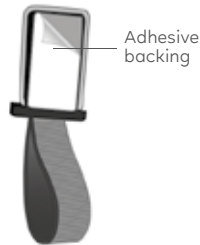

Adhesive backing

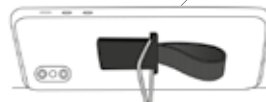

STAND

2 IN 1

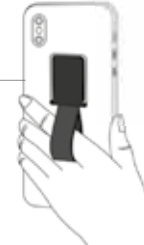

GRIP

Up to 9.7" and 400g

FOCUS ON

L 2.5 x H 5.5 x W 3.5 cm

3-IN-1 LENS SET WITH UNIVERSAL CLIP

- Material: ABS, glass, aluminium

KIT DI 3 LENTI IN 1 CON CLIP UNIVERSALE

- Materiale: ABS, vetro, alluminio

KIT D'OBJECTIFS 3 EN 1 AVEC CLIP UNIVERSEL

- Matériau : ABS, verre, aluminium

KIT DE OBJETIVOS 3 EN 1 CON CLIP UNIVERSAL

- Material: ABS, vidrio, aluminio

SET MIT 3 LINSEN IN 1, MIT UNIVERSALCLIP

- Material: ABS, Glas, Aluminium



Fisheye 180°

Wide-angle 0.65X

Macro 10X



PACKAGING
window box
L 7.8 x H 15.8 x W 3.8 cm
SOLD X 4

ML0002



WEBCAM COVER

2 small covers: L 0.9 x H 1.8 x W 0.01 cm

1 big cover: L 1.2 x H 2.9 x W 0.01 cm

SET OF 3 WEBCAM COVERS

- Material: ABS, 3M adhesive

SET DI 3 COVER PER WEBCAM

- Materiale: ABS, adesivo 3M

SET DE 3 CACHE WEBCAM

- Matériau : ABS, adhésif 3M

SET DE 3 FUNDAS PARA WEBCAM

- Material: ABS, adhesivo 3M

SET MIT 3 ABDECKUNG FÜR WEBCAM

- Material: ABS, 3M-Klebstoff

PACKAGING
carded
L 6.5 x H 12 x W 0.5 cm



DISPLAY
material: cardboard
L 16 x H 17 x W 8 cm
12 PCS

WECKIT1



Open

Slide

Close



FAN FOR FUN

Ø 6 cm, H 9.5 cm (fan blade)

PORTABLE MINI FAN

- Portable mini fan to carry everywhere with you on hot summer days
- Material: polycarbonate blades, aluminium handle

MINI VENTILATORE PORTATILE

- Mini ventilatore portatile da tenere sempre con sé nei caldi giorni estivi
- Materiale: pale in policarbonato, manico in alluminio

MINI VENTILATEUR PORTABLE

- Mini ventilateur portable à garder toujours sur soi, durant les chaudes journées d'été
- Matériau : pales en polycarbonate, manche en aluminium

MINI VENTILADOR PORTÁTIL

- Mini ventilador portátil para llevarlo siempre en los calurosos días de verano
- Material: aspas de policarbonato, mango de aluminio

TRAGBARER MINI-VENTILATOR

- Tragbarer Mini-Ventilator, der an heißen Sommertagen immer mitgenommen werden kann
- Material: Ventilatorflügel aus Polycarbonat, Griff aus Aluminium

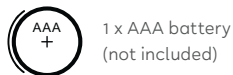

1 x AAA battery
(not included)

PACKAGING

carded
L 9.5 x H 15 cm



DISPLAY

material: cardboard
L 23 x H 24 x W 18 cm
12 PCS: 6 X COLOUR

PFKIT1



8 051128 751581



BLACK ■



RED ■

FAN FOR PHONE

Ø 9 cm (fan blade)

MINI FAN

- For iPhones, smartphones and tablets
- With USB-C, Micro-USB and Lightning adapter
- Material: TPE

MINI VENTILATORE

- Per iPhone, smartphone e tablet
- Con adattatore USB Tipo-C, Micro-USB e Lightning
- Materiale: TPE

MINI VENTILATEUR

- Pour iPhones, smartphones et tablettes
- Avec adaptateur USB Type-C, Micro USB et Lightning
- Matériau : TPE

MINI VENTILADOR

- Para iPhones, smartphones y tabletas
- Con adaptador USB Tipo C, Micro-USB y Lightning
- Material: TPE

MINI-VENTILATOR

- Für iPhones, Smartphones und Tablets
- Mit Adapter für USB Typ C, Micro-USB und Lightning
- Material: TPE



No batteries
needed

PACKAGING

carded
L 6 x H 15 x W 3 cm



DISPLAY

material: cardboard
L 15.5 x H 23.8 x W 16.8 cm
12 PCS

FANKIT2



8 051128 752588



For iPhones, smartphones
and tablets



USB-C, Micro-USB
and Lightning adapter



MINI FAN

L 6 x H 12 x W 2.5 cm (ice pop)
L 5.5 x H 12 x W 5.6 cm (pineapple)

PORTABLE MINI FAN

- Flexible blades
- Material: ABS, EVA

MINI VENTILATORE PORTATILE

- Pale flessibili
- Materiale: ABS, EVA

MINI VENTILATEUR PORTABLE

- Pales souples
- Matériau : ABS, EVA

MINIVENTILADOR PORTÁTIL

- Aspas flexibles
- Material: ABS, EVA

TRAGBARER MINI-VENTILATOR

- Flexible Flügelräder
- Material: ABS, EVA



2 x AAA batteries (not included)

PACKAGING

window box
L 8.5 x H 17.3 x W 3.5 cm

SOLD X 6

FAN0003



8 051739 306774



ICE POP



PACKAGING

window box
L 8.5 x H 17.3 x W 5.8 cm

SOLD X 6

FAN0004



8 052461 961637



PINEAPPLE

ME & YOU

AUDIO SPLITTER

- A 3.5 mm jack input that doubles into two audio outputs
- Material: soft plastic exterior, ABS and metal interior

SDOPPIATORE AUDIO

- Un ingresso jack da 3,5 mm che si sdoppia in due uscite audio
- Materiale: esterno in plastica morbida, interno in ABS e metallo

DOUBLEUR D'ÉCOUTEURS

- Une entrée jack de 3,5 mm se partageant en deux sorties audio
- Matériau : extérieur en plastique doux au toucher, intérieur en ABS et en métal

DIVISOR DE AURICULARES

- Un conector jack de 3,5 mm que se bifurca en dos salidas de audio
- Material: exterior de plástico blando, interior de ABS y metal

AUDIOVERDOPPLER

- Eine 3,5-mm-Klinkenbuchse, die sich in zwei Audioausgänge verdoppelt
- Material: außen aus weichem Kunststoff, innen aus ABS und Metall

✳ While stock lasts

INDIVIDUAL DESIGNS: SOLD X 3

PACKAGING

carded
L 8 x H 10 x
W 1.2 cm



FIRST ORDER: MOQ 1 FULL ASSORTED DISPLAY (14 PCS)

material: cardboard
L 19 x H 17.8 x W 15 cm

14 PCS: 2 X MY0001, MY0007, MY0012, MY0015, MY0019, MY0020, MY0021



MYKITS



8 052783 618783



MY0001



8 051070 278471

MY0007



8 052440 649860

MY0012



8 051764 522897



MY0015



8 056304 486196



MY0016



8 056304 486202



MY0020 ✳



8 052783 618776

SCREEN CLEANER

L MAX 3 x H MAX 3 x W MAX 0,1 cm

SCREEN CLEANER STICKERS

- Detachable and reusable
- Material: polyester, microfibre, silicone

ADESIVI PULISCI-SCHERMO

- Staccabili e riutilizzabili
- Materiale: poliestere, microfibra, silicone

ADHÉSIFS DE NETTOYAGE POUR ÉCRANS

- Amovibles et réutilisables
- Matériau : polyester, microfibre, silicone

ADHESIVOS LIMPIAPANTALLAS

- Se pueden despegar y volver a utilizar
- Material: poliéster, microfibra, silicone

KLEBENDEN DISPLAY-REINIGUNGSPADS

- Abnehmbar und wiederverwendbar
- Material: Polyester, Mikrofaser, Silikon



APPLY

CLEAN

REATTACH

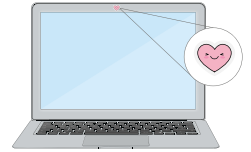

Can also be used as a webcam cover



GOOD VIBES

PACKAGING
cardboard envelope
w/window
L 6.5 x H 14.7 x W 0.2 cm

Set of 4



DISPLAY
material: cardboard
L 7 x H 18.2 x W 6.5 cm
12 PCS

SCSKIT1



TRAVEL

PACKAGING
cardboard envelope
w/window
L 6.5 x H 14.7 x W 0.2 cm

Set of 4



DISPLAY
material: cardboard
L 7 x H 18.2 x W 6.5 cm
12 PCS

SCSKIT2



SELFIE QUEEN

L 5.5 x H 8 x W 3 cm

SELFIE LIGHT

- 32 high-power LEDs
- USB charging cable included
- Material: plastic

LUCE PER SELFIE

- 32 LED ad alta potenza
- Cavo di ricarica USB incluso
- Materiale: plastica

LUMIÈRE POUR SELFIE

- 32 LED à haute puissance
- Câble USB pour la recharge de la batterie inclus
- Matériau : plastique

LUZ PARA SELFIS

- 32 LED de alta potencia
- Cable de carga USB incluido
- Material: plástico

SELFIE-LICHT

- 32 LEDs mit hoher Leistung
- USB-Kabel enthalten
- Material: Kunststoff

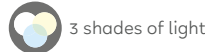
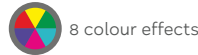

PACKAGING

window box
L 8.2 x H 16.8 x W 3.2 cm

SOLD X 4

SELF0001



QUEEN'S MIRROR

L 5.2 x H 8.7 cm

MIRROR FOR SMARTPHONE

- Contains: 2 dust-removal stickers, 1 wet wipe, 1 dry wipe and application instructions
- Equipped with reusable adhesive
- Shatter-proof
- Ultra-resistant tempered glass, super thin

SPECCHIO PER SMARTPHONE

- Contiene: 2 adesivi rimuovi-polvere, 1 salviettina umidificata, 1 salviettina asciutta, istruzioni per l'applicazione
- Dotato di adesivo riutilizzabile
- Anti-scheggiatura
- Vetro temperato ultra resistente, super sottile

MIROIR POUR SMARTPHONE

- Contient : 2 adhésifs anti-poussière, 1 lingette humide, 1 lingette sèche, les instructions pour l'application
- Pourvu d'adhésif réutilisable
- Anti-éclat
- Verre tempéré ultra-résistant, super fin

ESPEJO PARA SMARTPHONE

- Incluye: 2 adhesivos para quitar el polvo, 1 toallita húmeda, 1 toallita seca, instrucciones de aplicación
- Con adhesivo reutilizable
- Anti-astillado
- Vidrio templado ultra resistente, ultrafino

SPIEGEL FÜR DAS SMARTPHONE

- Enthält: 2 Kleber gegen Staub, 1 Feuchttuch, 1 trockenes Tuch, Bedienungsanleitung für das Aufkleben
- Mit einem wiederverwendbaren Kleber ausgestattet
- Haltbar gegenüber Absplitterungen
- Besonders haltbares, gehärtetes Glas, Besonders dünn

PACKAGING
cardboard envelope
L 7.5 x H 12.3 x W 0.2 cm



DISPLAY

material: cardboard
L 18 x H 16.5 x W 8.2 cm
12 PCS

PMKIT1



6 IN 1 KEYCHAIN CHARGING CABLE



L 7 cm (closed) - L 14 cm (open)

6 IN 1 KEYCHAIN CHARGING CABLE

- Can be used for data transfer and charging*
- It is also possible to transfer the charge from one device to another, using the side with the USB connector as the source
- Material: TPE, ABS

CAVO DI RICARICA PORTACHIAVI 6 IN 1

- Può essere utilizzato per il trasferimento dei dati e per la ricarica*
- È anche possibile trasferire la carica da un dispositivo all'altro, utilizzando il lato con il connettore USB come sorgente
- Materiale: TPE, ABS

CÂBLE DE RECHARGE PORTE-CLÉS 6-EN-1

- Il peut être utilisé pour le transfert des données et pour la recharge*
- Il est aussi possible de transférer la charge d'un appareil à l'autre, en se servant du côté avec le connecteur USB comme source
- Matériau : TPE, ABS

CABLE DE RECARGA LLAVERO 6 EN 1

- Puede utilizarse para transferir datos y para la carga*
- También es posible transferir la carga de un dispositivo a otro, utilizando el lado con el conector USB como fuente
- Material: TPE, ABS

6-IN-1-SCHLÜSSELANHÄNGER UND LADEKABEL

- Kann zur Datenübertragung und zum Aufladen verwendet werden*
- Auch die Übertragung der Aufladung zwischen Geräten ist möglich, wobei die Seite mit dem USB-Stecker als Quelle dient
- Material: TPE, ABS

*Does not support data storage

PACKAGING

carded
L 14,5 x H 9 x W 1 cm
SOLD X 6

UCC0009

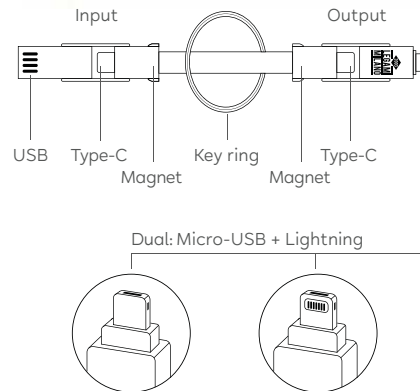

Connections:
USB to Micro-USB
USB to Type-C
USB to Lightning
Type-C to Micro-USB
Type-C to Type-C
Type-C to Lightning

THREE HUGS

L 120 cm

CHARGING AND SYNCHRONIZATION MULTI CABLE

- 4 cables: USB, type-C, Micro USB and Lightning
- Material: TPE

CAVO MULTIPLO DI RICARICA E SINCRONIZZAZIONE

- 4 cavi: USB, tipo- C, Micro- USB e Lightning
- Materiale: TPE

CÂBLE MULTIPLE DE RECHARGE ET SYNCHRONISATION

- 4 câbles : USB, type- C, Micro- USB et Lightning
- Matériau : TPE

CABLE MÚLTIPLE DE RECARGA Y SINCRONIZACIÓN

- 4 cables: USB, tipo- C, Micro USB y Lightning
- Material: TPE

MEHRFACH-LADE- UND SYNCHRONISIERUNGSKABEL

- 4 kabel: USB, typ C, Micro- USB und Lightning
- Material: TPE

PACKAGING

cardboard box
L 8.1 x H 17.5 x W 2.1 cm
SOLD X 4

CCA0001

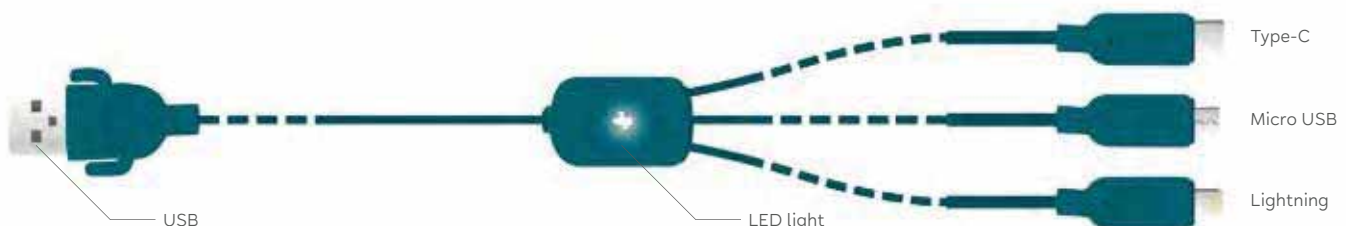

LINK UP

L MAX 5 x H MAX 16 x W MAX 4.2 cm (without hook)

MULTIPLE CHARGING* CABLE

- 4 cables: USB, Type-C, Micro USB and Lightning
- Material: metal, TPE and PVC. TPE coated cable

CAVO DI RICARICA* MULTIPLO

- 4 cavi: USB, Tipo-C, Micro-USB e Lightning
- Materiale: metallo, TPE, PVC. Cavo rivestito in TPE

CÂBLE DE RECHARGE* MULTIPLE

- 4 câbles : USB, Type-C, Micro-USB et Lightning
- Matériau : métal, TPE, PVC. Câble revêtu en TPE

*Does not support data sync.

CABLE DE RECARGA* MÚLTIPLE

- 4 cables: USB, Tipo-C, Micro USB y Lightning
- Material: metal, TPE, PVC. Cable revestido de TPE

MEHRFACH-LADEKABEL*

- 4 Kabel: USB, Typ C, Micro-USB und Lightning
- Material: Metall, TPE, PVC. Mit TPE beschichtetes Kabel

PACKAGING

carded
L 9 x H 20 x W MAX 4.2 cm
SOLD X 3



<p>AVOCADO UCC0001</p>  <p>8 059174 833022</p>	<p>8 BALL UCC0004</p>  <p>8 059174 833985</p>	<p>PANDA UCC0005</p>  <p>8 052461 964775</p>	<p>RAINBOW UCC0006</p>  <p>8 052461 964782</p>	<p>HEART UCC0007</p>  <p>8 052461 964799</p>	<p>MARSHMALLOW UCC0008</p>  <p>8 052461 964805</p>
--	---	--	--	--	--

USB FLASH DRIVE

L MAX 4 x H MAX 4.8 x W MAX 2.5 cm

16 GB USB FLASH DRIVE

- USB interface: 3.0 (backward compatible with 2.0 USB ports)
- Material: soft PVC coating

CHIAVETTA USB 16 GB

- Interfaccia USB: 3.0 (retrocompatibile con porte USB 2.0)
- Materiale: rivestimento in morbido PVC

CLÉ USB 16 Go

- Interface USB : 3.0 (elle est rétrocompatible avec les ports USB 2.0)
- Matériau : revêtement en PVC doux

MEMORIA USB 16 GB

- Interfaz USB: 3.0 (retrocompatible con puertos USB 2.0)
- Material: revestimiento en PVC blando

USB-STICK MIT 16 GB

- USB-Schnittstelle: 3.0 (abwärtskompatibel mit USB-Ports des Standards 2.0)
- Material: Beschichtung aus weichem PVC

PACKAGING

carded
L 12.5 x H 8 x W MAX 2.7 cm
SOLD X 3



<p>AVOCADO USB0001</p>  <p>8 052461 964850</p>	<p>MARSHMALLOW USB0002</p>  <p>8 052461 964867</p>	<p>PANDA USB0003</p>  <p>8 052461 964874</p>	<p>ROCKET USB0004</p>  <p>8 052461 964881</p>
--	--	--	---

PUMP UP THE VOLUME

Ø 4 cm, H 4.5 cm

MINI WIRELESS HANDS-FREE SPEAKER

- Take selfies remotely
- Compatible with devices with Bluetooth® technology
- Material: external coating in rubber, interior in plastic

MINI VIVAVOCE E SPEAKER WIRELESS

- Scatta selfie da remoto
- Compatibile con i dispositivi con tecnologia Bluetooth®
- Materiale: rivestimento esterno in gomma, interno in plastica

MINI HAUT-PARLEUR ET BAFFLE SANS FIL

- Il permet de prendre des selfies à distance
- Compatible avec les dispositifs munis de technologie Bluetooth®
- Matériau : revêtement en caoutchouc, intérieur en plastique

MINI MANOS LIBRES Y ALTAVOZ INALÁMBRICO

- Echa selfis a distancia
- Compatible con los dispositivos con tecnología Bluetooth®
- Material: revestimiento de goma, interior de plástico

MINI-WIRELESS -FREISPRECHEINRICHTUNG UND -SPEAKER

- Kann Selfies aus der Ferne aufnehmen
- Kompatibel mit den Geräten mit Bluetooth-Technologie®
- Material: Aussenmaterial in Gummi, Innenmaterial in Plastik

PACKAGING

window box w/hook
L 8 x H 16 x 4.5 cm

SOLD X 2

MSP0001



8 051739 306279

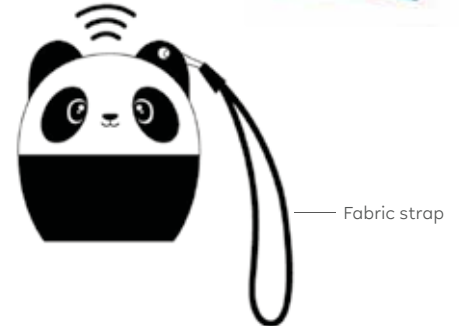
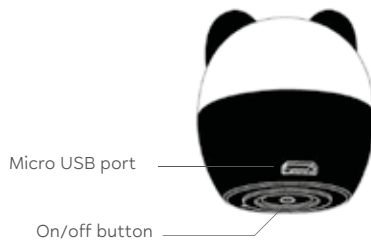
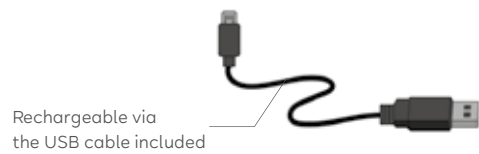

SINGING IN THE SHOWER

Ø 8.5 cm, W 5 cm

WATER-RESISTANT BLUETOOTH® HANDS-FREE SPEAKER

- Compatible with all devices with Bluetooth® technology
- Material: silicone, ABS

VIVAVOCE E SPEAKER BLUETOOTH® RESISTENTE ALL'ACQUA

- Compatibile con tutti i dispositivi con tecnologia Bluetooth®
- Materiale: silicone, ABS

HAUT-PARLEUR ET BAFFLE BLUETOOTH® RÉISTANT À L'EAU

- Compatible avec tous les dispositifs munis de technologie Bluetooth®
- Matériau : silicone, ABS

MANOS LIBRES Y ALTAVOZ BLUETOOTH® RESISTENTE AL AGUA

- Compatible con todos los dispositivos con tecnología Bluetooth®
- Material: silicona, ABS

WASSERABWEISENDE BLUETOOTH® -FREISPRECHEINRICHTUNG UND -SPEAKER

- Kompatibel mit allen Geräten mit Bluetooth®-Technologie
- Material: Silikon, ABS

PACKAGING

window box w/hook
L 10 x H 17 x W 5.5 cm

SOLD X 2



* While stock lasts

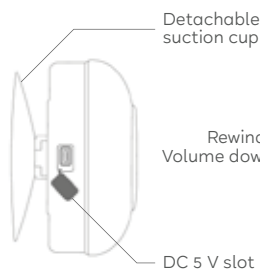
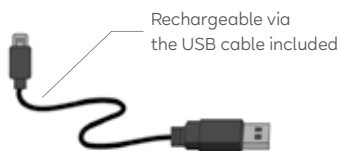

Rewind (short press)
Volume down (long press)

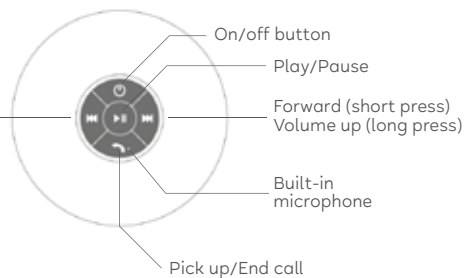

TAKE IT EASY
SHOW0001



8 052783 618516



TRAVEL
SHOW0003



8 052783 618530



BLOOM
SHOW0004 *



8 052783 618547



AFTER RAIN
SHOW0005



8 052461 965741



FLASH
SHOW0006



8 052461 965758



FLORA
SHOW0007



8 052461 965765

AIR 'N GO



CASE AND CORD SET FOR AIRPODS

- Includes three pieces: case, cord and carabiner
- Material: silicone, aluminium carabiner

SET CUSTODIA E CORDINO PER AIRPODS

- Include tre pezzi: custodia, cordino per collo e moschettone
- Materiale: silicone, moschettone in alluminio

ÉTUI + TOUR DE COU POUR AIRPODS

- Ensemble de trois articles comprenant : étui, tour de cou et mousqueton
- Matériau : silicone, mousqueton en aluminium

SET DE FUNDA Y CORDÓN PARA AIRPODS

- Incluye tres piezas: funda, cordón para el cuello y mosquetón
- Material: silicona, mosquetón de aluminio

SET BESTEHEND AUS HÜLLE UND BAND FÜR AIRPODS

- Enthält drei Teile: Hülle, Band zum Umhängen und Karabiner
- Material: Silikon, Karabiner aus Aluminium

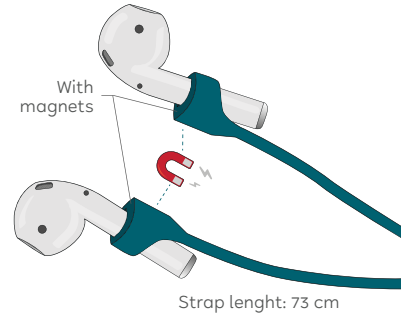

Shock resistant



Water resistant



Wireless charging compatible



FOR AIRPODS 1&2

*AirPods and charging case not included



AIR0001 PETROL BLUE
8 054320 561279



AIR0002TURQUOISE
8 054320 561286

PACKAGING

carded
L 11 x H 14.5 x W 2.7 cm
SOLD X 6



FOR AIRPODS PRO



AIR0003 PETROL BLUE
8 054320 561293



AIR0004TURQUOISE
8 054320 561309

PACKAGING

carded
L 11 x H 15.5 x W 2.7 cm
SOLD X 6



SUPER FAST

Ø MAX 10 cm

SMARTPHONE WIRELESS CHARGER

- Compatible with smartphones with Qi technology
- Material: silicone

CARICABATTERIE WIRELESS PER SMARTPHONE

- Compatibile con smartphone con tecnologia Qi
- Materiale: silicone

CHARGEUR SANS FIL POUR SMARTPHONE

- Compatible avec les smartphones de technologie Qi
- Matériau : silicone

CARGADOR INALÁMBRICO PARA SMARTPHONE

- Compatible con smartphones con tecnología Qi
- Material: silicona

KABELLOSE LADESTATION FÜR SMARTPHONE

- Kompatibel mit Smartphones mit Qi-Technologie
- Material: Silikon



PACKAGING

window box w/hook
L 12.5 x H 12.5 x W 2.4 cm
SOLD X 3

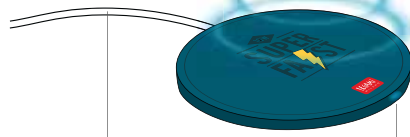
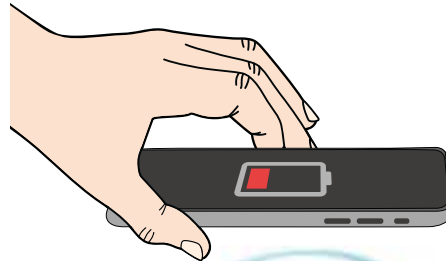

USB cable included

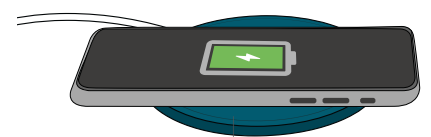

LED charging light

Non-slip surface



AVOCADO
WCHAR001



8 052461 964577



PANDA
WCHAR002



8 052461 964584



PETROL
WCHAR003



8 052461 964591



RAINBOW
WCHAR004



8 052461 964607



VINYL
WCHAR005



8 052461 964904



TRAVEL
WCHAR006



8 052461 964911

SUPER FAST



L 7 x H 11 x W 8 cm

WIRELESS CHARGING STAND

- Compatible with smartphones with Qi technology
- Material: ABS

CARICABATTERIE WIRELESS CON SUPPORTO

- Compatibile con smartphone con tecnologia Qi
- Materiale: ABS

CHARGEUR SANS FIL AVEC SUPPORT

- Compatible avec les smartphones de technologie Qi
- Matériau : ABS

CARGADOR INALÁMBRICO CON SOPORTE

- Compatible con smartphones con tecnología Qi
- Material: ABS

KABELLOSE LADESTATION MIT HALTERUNG

- Kompatibel mit Smartphones mit Qi-Technologie
- Material: ABS

PACKAGING

cardboard box w/hook
L 9,5 x H 12 x W 7,7 cm

SOLD X 4

WCHAR0007

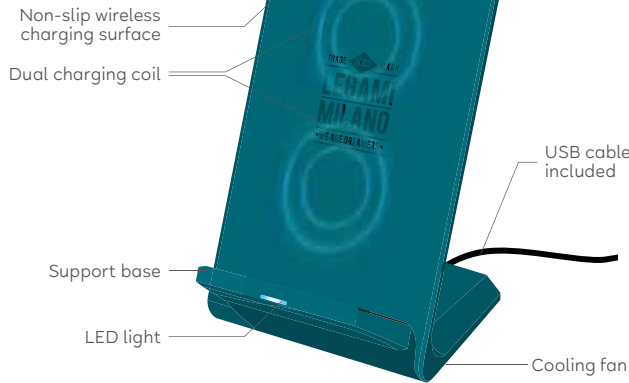

MEOW POWER BANK

Ø 4 cm, H 9.5 cm

POWER BANK

- Material: ABS

BATTERIA RICARICABILE

- Materiale: ABS

BATTERIE EXTERNE

- Matériau : ABS

BATERÍA EXTERNA RECARGABLE

- Material: ABS

POWERBANK

- Material: ABS

PACKAGING

PET box w/hook
L 6 x H 15 x W 6 cm

SOLD X 2

POW0007



MY SUPER POWER

L MAX 13 x H MAX 13 x W MAX 5.5 cm

POWER BANK
• Material: ABS

BATTERIA RICARICABILE
• Materiale: ABS

BATTERIE EXTERNE
• Matériau : ABS

BATERÍA EXTERNA RECARGABLE
• Material: ABS

POWERBANK
• Material: ABS

* While stock lasts

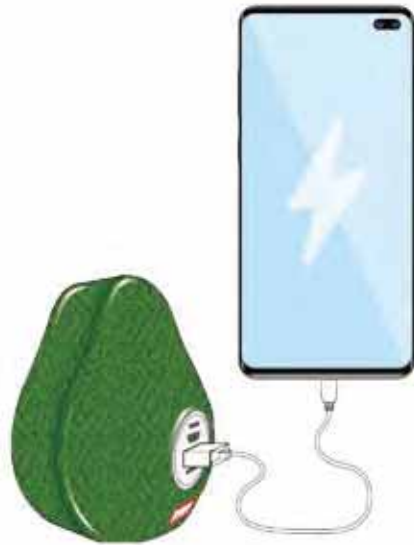

PACKAGING
window box w/hook
L MAX 13.5 x H MAX 17
x W MAX 5.7 cm
SOLD X 2



AVOCADO
POW0001



8 059174 833213



DINOSAUR
POW0004 *



8 059174 833244



CACTUS
POW0005



8 059174 833251



BANG!
POW0006



8 059174 833268



FLASH
POW0009



8 052461 964737



ROCKET
POW0010



8 052461 964744



BOOMBOX
POW0011



8 052461 964751



PANDA
POW0012



8 052461 964768

POWER MAN

L 6.2 x H 9 x W 1 cm

POWER BANK

- 2 USB ports: charges up to two devices simultaneously
- Material: ABS

BATTERIA RICARICABILE

- 2 porte USB: ricarica fino a due dispositivi contemporaneamente
- Materiale: ABS

BATTERIE EXTERNE

- 2 ports USB : elle recharge jusqu'à deux appareils en même temps
- Matériau : ABS

BATERÍA EXTERNA RECARGABLE

- 2 puertos USB: recarga hasta dos dispositivos a la vez
- Material: ABS

POWERBANK

- 2 USB-Ports: bis zu zwei Geräte gleichzeitig aufladen
- Material: ABS



USB output

Micro USB input

USB output



LED light battery indicator

PACKAGING
carded
L 9 x H 17 x W 3 cm
SOLD X 2

POW0008



USB charging cable included

WIRELESS POWER MAN



L 6.3 x H 9.5 x W 1.5 cm

PORTABLE WIRELESS POWER BANK

- Suitable for wireless charging of smartphones with Qi technology
- 2 in 1: you can charge 2 devices simultaneously via wireless and/or USB charging
- Material: ABS, silicone micro suction cups

CARICABATTERIE WIRELESS PORTATILE

- Adatto per la ricarica wireless di smartphone con tecnologia Qi
- 2 in 1: è possibile ricaricare 2 dispositivi contemporaneamente tramite carica wireless e/o tramite USB
- Materiale: ABS, micro ventose in silicone

CHARGEUR SANS FIL PORTABLE

- Adapté pour la recharge sans fil de smartphones dotés de la technologie Qi
- 2-en-1 : il est possible de recharger 2 appareils en même temps par l'intermédiaire de la recharge sans fil et/ou USB
- Matériau : ABS, micro-ventouses en silicone

CARGADOR DE BATERÍA INALÁMBRICO PORTÁTIL

- Apto para la carga inalámbrica de smartphones con tecnología Qi
- 2 en 1: se pueden cargar 2 dispositivos a la vez con carga inalámbrica y/o con USB
- Material: ABS, microventosas en silicona

TRAGBARE KABELLOSE POWERBANK

- Geeignet für das kabellose Aufladen von Smartphones, die über die Qi-Technologie verfügen
- 2 in 1: Ermöglicht das Aufladen von bis zu 2 Geräten mit der kabellosen Ladefunktion und/oder via USB gleichzeitig
- Material: ABS, kleinen Saugnäpfen aus Silikon



Micro USB input

12 micro suction cups

USB output

PACKAGING
cardboard box w/hook
L 10.5 x H 16 x W 2 cm
SOLD X 2

POW0015



LED light battery indicator



USB charging cable included



PLUG & CHARGE - USB + USB-C

L 2.5 x H 4.2 x W 8.2 cm

WALL CHARGER

- 1 USB port and 1 USB-C port
- Type-C plug (European 2-pin)
- Material: plastic

CARICABATTERIE DA MURO

- 1 porta USB e 1 porta USB Tipo-C
- Spina di tipo C (europea a due poli)
- Materiale: plastica

CHARGEUR MURAL

- 1 Port USB et 1 port USB Type-C
- Prise de type-C (européenne à deux broches)
- Matériau : plastique

CARGADOR DE PARED

- 1 puerto USB y 1 puerto USB tipo C
- Enchufe tipo C (europeo de dos polos)
- Material: plástico

LADEGERÄT

- 1 USB-Port und 1 USB-C-Port
- Typ-C-Stecker (Eurostecker, zweipolig)
- Material: Kunststoff

PACKAGING

PVC box w/hook
L 4.5 x H 10.5 x W 2.8 cm



DISPLAY

material: cardboard
L 9.4 x H 15 x W 9 cm

6 PCS

WACHKIT1



8 051128 754940



UP TO 2 DEVICES



FAST CHARGE



SAFE CHARGING

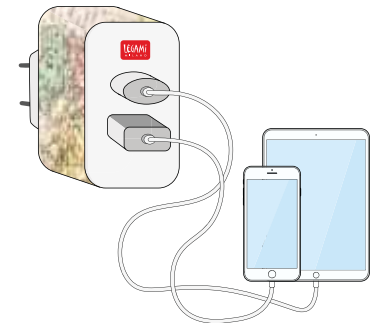

Compatibility



PLUG & CHARGE - 3 USB

L 2.3 x H 6 x W 7 cm

WALL CHARGER

- 3 USB ports
- Type-C plug (European 2-pin)
- Material: plastic

CARICABATTERIE DA MURO

- 3 porte USB
- Spina di tipo C (europea a due poli)
- Materiale: plastica

CHARGEUR MURAL

- 3 ports USB
- Prise de type-C (européenne à deux broches)
- Matériau : plastique

CARGADOR DE PARED

- 3 puertos USB
- Enchufe tipo C (europeo de dos polos)
- Material: plástico

LADEGERÄT

- 3 USB-Ports
- Typ-C-Stecker (Eurostecker, zweipolig)
- Material: Kunststoff

PACKAGING

PVC box w/hook
L 6 x H 8.8 x W 2.5 cm



DISPLAY

material: cardboard
L 13 x H 12.5 x W 8 cm

6 PCS

WACHKIT2



8 051128 754957



UP TO 3 DEVICES



FAST CHARGE



SAFE CHARGING

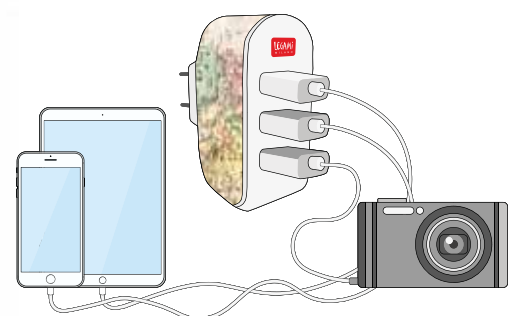

Compatibility



ALWAYS TOGETHER



L 53 cm (tether included)

PHONE LANYARD

- Multifunction: lanyard with hook can also be used as a key holder
- Does not interfere with the charging cable input
- Material: polyester, metal hook, adhesive tether

LACCIO PORTA CELLULARE

- Multifunzione: laccio con gancio utilizzabile anche come porta chiavi
- Non interferisce con l'ingresso del cavo di ricarica
- Materiale: poliestere, gancio in metallo, linguetta adesiva

CORDON PORTE-TÉLÉPHONE MOBILE

- Multifonctions : cordon avec crochet utilisable aussi comme porte-clés
- Il n'interfère pas avec l'entrée du câble de recharge
- Matériau : polyester, crochet en métal, languette adhésive

CORDÓN PARA MÓVIL

- Multifunción: cordón con gancho que también puede utilizarse como llavero
- No cubre la entrada del cable de recarga
- Material: poliéster, gancho de metal, lengüeta adhesiva

HANDYTRAGEBAND

- Multifunktion: Band mit Haken, auch als Schlüsselanhänger
- Keine Interferenz mit dem Eingang des Ladekabels
- Material: Polyester, Haken aus Metall, Klebelasche

PACKAGING

cardboard box
L 9 x H 15 x W 1.7 cm
SOLD X 6



Metal hook



Fabric lanyard



Secure and resistant



Adhesive tether

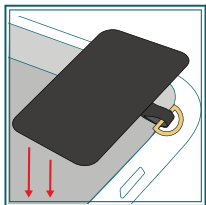

1. Position

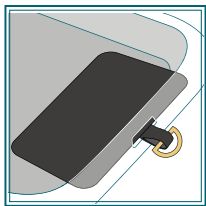

2. Insert

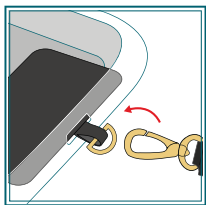

3. Hook



FLORA
PHL0001



8 052461 966168



FLASH
PHL0002



8 052461 966175

WIRELESS MOUSE



L 6.5 x H 10 x W 3.5 cm

WIRELESS MOUSE WITH USB RECEIVER

- 2.4 GHz wireless optical mouse
- Ultra-compact USB receiver
- Three speed options: 800 DPI, 1200 DPI and 1600 DPI
- Material: ABS

MOUSE WIRELESS CON RICEVITORE USB

- Mouse ottico wireless 2,4 GHz
- Ricevitore USB ultra compatto
- Tre opzioni di velocità: 800 DPI, 1200 DPI e 1600 DPI
- Materiale: ABS

SOURIS SANS FIL AVEC RÉCEPTEUR USB

- Souris optique sans fil 2,4 GHz
- Récepteur USB ultracompact
- Trois options de vitesse : 800 DPI, 1200 DPI et 1600 DPI
- Matériau : ABS

RATÓN INALÁMBRICO CON RECEPTOR USB

- Ratón óptico inalámbrico 2,4 GHz
- Receptor USB ultracompacto
- Tres velocidades: 800 DPI, 1200 DPI y 1600 DPI
- Material: ABS

KABELLOSE MAUS MIT USB-EMPFÄNGER

- Optische, kabellose Maus mit 2,4 GHz
- Ultrakompakter USB-Empfänger
- Drei Geschwindigkeitsstufen: 800 DPI, 1200 DPI und 1600 DPI
- Material: ABS

PACKAGING

window box w/hook
L 12.2 x H 21 x W 4.5 cm
SOLD X 4



USB 2.0 interface



Nano receiver included



Ambidextrous design



Wireless connection



1 x AA battery (not included)



TRAVEL
WM00001



8 054320 561019



GENIUS
WM00002



8 054320 561026



FLORA
WM00003



8 054320 561033



PANDA
WM00004



8 054320 561040

LAPTOP TRAY

L 44 x H 33.5 x W 4 cm

LAPTOP TRAY

- Also perfect as a tablet holder
- Soft cushion with padding
- Material: MDF, polyester. Padding: 100% polystyrene

SUPPORTO PER COMPUTER PORTATILE

- Perfetto anche come supporto per tablet
- Morbido cuscino con imbottitura
- Materiale: MDF, poliestere. Imbottitura: 100% polistirene

SUPPORT POUR ORDINATEUR PORTABLE

- Support également parfait pour les tablettes
- Coussin moelleux avec rembourrage
- Matériau : MDF, polyester. Rembourrage : 100 % polystyrène

BANDEJA PARA ORDENADOR PORTÁTIL

- Perfecta también como soporte para tabletas
- Cojín blando con relleno
- Material: MDF, poliéster. Relleno: 100 % poliestireno

LAPTOPKISSEN

- Auch als Tabletkissen perfekt geeignet
- Weiches Kissen mit Füllung
- Material: MDF, Polyester. Füllung: 100% Polystyrol



LAPTOP

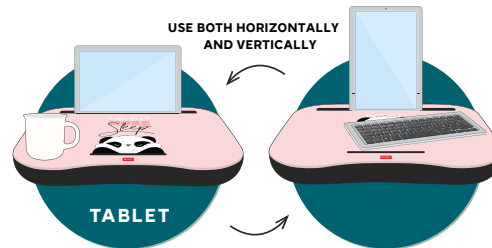

TABLET

USE BOTH HORIZONTALLY AND VERTICALLY



TRAVEL

PACKAGING
cardboard belly band
SOLD X 2

LDESK001



8 059174 839987



PANDA

PACKAGING
cardboard belly band
SOLD X 2

LDESK002



8 059174 839994

MOUSEPAD

L 21 x H 18 cm

MOUSEPAD

• Material: dust-proof and anti-glare PVC surface; 2.5 mm anti-slip rubber base

TAPPETINO PER MOUSE

• Materiale: superficie antipolvere e antiriflesso in PVC; base in gomma antiscivolo da 2,5 mm

TAPIS DE SOURIS

• Matériau : surface anti-poussière et antireflet en PVC ; base en caoutchouc antidérapant, épaisseur 2,5 mm

ALFOMBRILLA PARA RATÓN

• Material: superficie antipolvo y antirreflejo de PVC; base de goma antideslizante de 2,5 mm

MOUSEPAD

• Material: Anti-Staub- und Anti-Reflex-Oberfläche aus PVC; Basis aus rutschfestem Gummi in 2,5 mm Dicke

PACKAGING

carded
L 23.5 x H 22 x
W 0.4 cm

SOLD X 2



MOU0001



8 056304 482327



MOU0007



8 056304 482389



MOU0010



8 051122 263615



MOU0011



8 051122 263622



MOU0012



8 051122 263639



MOU0014



8 052783 616376



MOU0015



8 052783 616383



MOU0016



8 052783 616390



MOU0017



8 052783 616406



MOU0018



8 052783 616413



MOU0019



8 052783 616420

TABLET SLEEVE

UNIVERSAL SLEEVE FOR TABLETS

- With metal zip and slider
- Material: external covering in nylon, interior in padded material

CUSTODIA UNIVERSALE PER TABLET

- Con cerniera e cursore in metallo
- Materiale: rivestimento esterno in Nylon, interno in materiale imbottito

POCHETTE UNIVERSELLE POUR TABLETTE

- Avec fermeture et glissière en métal
- Matériau : revêtement extérieur en Nylon, intérieur en matériau rembourré

FUNDA UNIVERSAL PARA TABLETAS

- Con cremallera y cursor de metal
- Material: revestimiento exterior en nylon, interior en material acolchado

UNIVERSALE HÜLLE FÜR TABLETS

- Mit Reißverschluss und Metallschieber
- Material: Außenbezug aus Nylon, Innenbezug aus gepolstertem Material

* While stock lasts

MINI TABLET SLEEVE 6"-7"

L 22 x H 15.5 x W 2 cm

For tablets and iPads from 6 to 7 inches in size



PACKAGING

window box
L 22.5 x H 19.6 x W 2.8 cm

SOLD X 1

TABLET SLEEVE 9"-10.5"

L 26.5 x H 20.5 x W 2 cm

For tablets and iPads from 9 to 10.5 inches in size



PACKAGING

window box
L 27 x H 24.5 x W 2.8 cm

SOLD X 1



MINI TABLET SLEEVE 6"-7"

SLM0001



8 056304 482525

TABLET SLEEVE 9"-10.5"

SLE0001



8 056304 482440



MINI TABLET SLEEVE 6"-7"

SLM0002



8 056304 482532

TABLET SLEEVE 9"-10.5"

SLE0002 *



8 056304 482457



MINI TABLET SLEEVE 6"-7"

SLM0003



8 056304 482549



MINI TABLET SLEEVE 6"-7"

SLM0004



8 056304 482556

TABLET SLEEVE 9"-10.5"

SLE0004



8 056304 482471

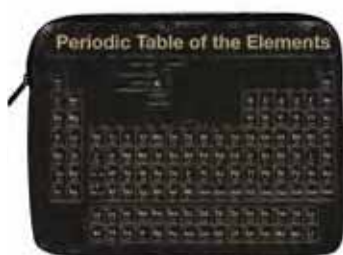

MINI TABLET SLEEVE 6"-7"

SLM0005



8 056304 482563

TABLET SLEEVE 9"-10.5"

SLE0005



8 056304 482488



MINI TABLET SLEEVE 6"-7"

SLM0006



8 056304 482570

TABLET SLEEVE 9"-10.5"

SLE0006



8 056304 482495



MINI TABLET SLEEVE 6"-7"

SLM0007



8 056304 482587

TABLET SLEEVE 9"-10.5"

SLE0007



8 056304 482501



MINI TABLET SLEEVE 6"-7"

SLM0008



8 056304 482594

TABLET SLEEVE 9"-10.5"

SLE0008 *



8 056304 482518

IPHONE 12 MINI CLEAR CASE



IPHONE 12 MINI CASE

- Material: high quality TPU, resistant to dirt and scratches

COVER IPHONE 12 MINI

- Materiale: TPU di elevata qualità, resistente allo sporco e alle abrasioni

COQUE IPHONE 12 MINI

- Matériau : TPU de haute qualité, résistant à la saleté et aux abrasions

CARCASA PARA IPHONE 12 MINI

- Material: TPU de elevada calidad, resistente a la suciedad y a las abrasiones

IPHONE 12 MINI HANDY-COVER

- Material: hochwertiges TPU, widerstandsfähig gegen Schmutz und Abrieb

PACKAGING

carded
L 9.7 x H 18.8 cm
SOLD X 1



Allows access to controls and ports

Soft TPU material



IPHONE 12 / 12 PRO CLEAR CASE



IPHONE 12 / 12 PRO CASE

- Material: high quality TPU, resistant to dirt and scratches

COVER IPHONE 12 / 12 PRO

- Materiale: TPU di elevata qualità, resistente allo sporco e alle abrasioni

COQUE IPHONE 12 / 12 PRO

- Matériau : TPU de haute qualité, résistant à la saleté et aux abrasions

CARCASA PARA IPHONE 12 / 12 PRO

- Material: TPU de elevada calidad, resistente a la suciedad y a las abrasiones

IPHONE 12 / 12 PRO HANDY-COVER

- Material: hochwertiges TPU, widerstandsfähig gegen Schmutz und Abrieb

PACKAGING

carded
L 10 x H 19.5 cm
SOLD X 1



Allows access to controls and ports

Soft TPU material



IPHONE 12 PRO MAX CLEAR CASE



IPHONE 12 PRO MAX CASE

- Material: high quality TPU, resistant to dirt and scratches

COVER IPHONE 12 PRO MAX

- Materiale: TPU di elevata qualità, resistente allo sporco e alle abrasioni

COQUE IPHONE 12 PRO MAX

- Matériau : TPU de haute qualité, résistant à la saleté et aux abrasions

CARCASA PARA IPHONE 12 PRO MAX

- Material: TPU de elevada calidad, resistente a la suciedad y a las abrasiones

IPHONE 12 PRO MAX HANDY-COVER

- Material: hochwertiges TPU, widerstandsfähig gegen Schmutz und Abrieb

PACKAGING

- carded
- L 10,5 x H 20,5 cm
- SOLD X 1**



Allows access to controls and ports



Soft TPU material

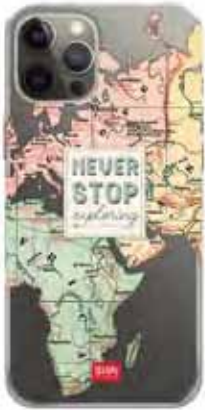

CCIPXIIP001



8 054320 560876



CCIPXIIP004



8 054320 560906



CCIPXIIP005



8 054320 560913



CCIPXIIP006



8 054320 560920



CCIPXIIP007



8 054320 560937



CCIPXIIP008



8 054320 560944

IPHONE 11 PRO CLEAR CASE

IPHONE 11 PRO CASE

- Material: high quality TPU, resistant to dirt and scratches

COVER IPHONE 11 PRO

- Materiale: TPU di elevata qualità, resistente allo sporco e alle abrasioni

COQUE IPHONE 11 PRO

- Matériau : TPU de haute qualité, résistant à la saleté et aux abrasions

CARCASA PARA IPHONE 11 PRO

- Material: TPU de elevada calidad, resistente a la suciedad y a las abrasiones

IPHONE 11 PRO HANDY-COVER

- Material: hochwertiges TPU, widerstandsfähig gegen Schmutz und Abrieb

PACKAGING

- carded
- L 10 x H 19 cm
- SOLD X 1**



Allows access to controls and ports



Soft TPU material



CCIPXIIR001



8 059174 835002



CCIPXIIR002



8 059174 835019



CCIPXIIR003



8 059174 835026



CCIPXIIR004



8 059174 835033



CCIPXIIR005



8 059174 835040



CCIPXIIR006



8 059174 835057

IPHONE X/XS CLEAR CASE

IPHONE X/XS CASE

• Material: high quality TPU, resistant to dirt and scratches

COVER IPHONE X/XS

• Materiale: TPU di elevata qualità, resistente allo sporco e alle abrasioni

COQUE IPHONE X/XS

• Matériau : TPU de haute qualité, résistant à la saleté et aux abrasions

CARCASA PARA IPHONE X/XS

• Material: TPU de elevada calidad, resistente a la suciedad y a las abrasiones

IPHONE X/XS HANDY-COVER

• Material: hochwertiges TPU, widerstandsfähig gegen Schmutz und Abrieb

* While stock lasts

PACKAGING
carded
L 10 x H 19 cm
SOLD X 1



Allows access to controls and ports



Soft TPU material



CCIPX001 *



8 052783 612576



CCIPX002 *



8 052783 612583



CCIPX003 *



8 052783 612590



CCIPX007 *



8 052783 612637



CCIPX008 *



8 052783 612644

SILVER FOIL



CCIPX010 *



8 052783 612668



CCIPX011 *



8 052783 612675

SILVER FOIL



CCIPX014 *



8 051739 306453



CCIPX015 *



8 051739 306460

GOLD FOIL



CCIPX016 *



8 051739 306477

SILVER FOIL



CCIPX017 *



8 051739 306491



CCIPX018 *



8 051739 306507

PINK FOIL



CCIPX019 *



8 051739 306514



CCIPX020 *



8 051739 306521

PINK GLITTER

IPHONE XS MAX CLEAR CASE

IPHONE XS MAX CASE

- Material: high quality TPU, resistant to dirt and scratches

COVER IPHONE XS MAX

- Materiale: TPU di elevata qualità, resistente allo sporco e alle abrasioni

COQUE IPHONE XS MAX

- Matériau : TPU de haute qualité, résistant à la saleté et aux abrasions

CARCASA PARA IPHONE XS MAX

- Material: TPU de elevada calidad, resistente a la suciedad y a las abrasiones

IPHONE XS MAX HANDY-COVER

- Material: hochwertiges TPU, widerstandsfähig gegen Schmutz und Abrieb

* While stock lasts

PACKAGING

carded
L 10.3 x H 20 cm
SOLD X 1



Allows access to controls and ports



Soft TPU material



CCIPXSM001 *



8 051739 306644



GOLD FOIL

CCIPXSM002



8 051739 306651



SILVER FOIL

CCIPXSM003



8 051739 306668



CCIPXSM005



8 051739 306682

DISPLAYS ON DEMAND



EMPTY DISPLAY ON DEMAND

material: metal
minimum order qty: 50 pcs
L 16.5 x H 49 x W 16.5 cm
10 hooks (hook capacity 5 pcs)

DISCCL



8 051122 265503



EMPTY DISPLAY ON DEMAND

material: cardboard
minimum order qty: 30 pcs
L 32 x H 36.5 x W 22 cm
SUITABLE FOR ALL MODELS

DISCASES



8 057093 532323



Bikeaholic

COLLECTION



BIKE LOCK

Ø 1.4 cm, L 75 cm

LOCK WITH NUMBER COMBINATION

- Customisable 4-number combination
- Water resistant, cut resistant
- Material: ABS, zinc, polyester exterior, PVC central part, iron interior

LUCCHETTO CON COMBINAZIONE NUMERICA

- Combinazione a 4 numeri personalizzabile
- Resistente all'acqua, resistente al taglio
- Materiale: ABS, zinco, esterno in poliestere, parte centrale in PVC, interno in ferro

CADENAS À COMBINAISON NUMÉRIQUE

- Combinaison à 4 chiffres personnalisable
- Résistant à l'eau, résistant aux tentatives de coupe
- Matériau : ABS, zinc, extérieur en polyester, partie centrale en PVC, intérieur en fer

CANDADO CON COMBINACIÓN NUMÉRICA

- Combinación de 4 números personalizable
- Resistente al agua, resistente al corte
- Material: ABS, cinc, exterior de poliéster, parte central de pvc, interior de hierro

FAHRRAD-ZAHLENSCHLOSS

- Frei wählbare Kombination aus 4 Ziffern
- Wasserfest, Schnitffest
- Material: ABS, Zink, außen aus Polyester, zwischenschicht aus PVC, innen aus Eisen

PACKAGING

carded
L 14 x H 21 x W 3.5 cm

SOLD X 4

BIL0001



8 051739 309270



BIKE CLEANING CLOTH

L 17 x H 16 cm (open)

SADDLE CLEANING CLOTH

- Velcro closure for fixing to the frame
- Material: exterior in polyester, interior in microfibre

PANNO PULISCI SELLA

- Chiusura in velcro per fissaggio al telaio
- Materiale: esterno in poliestere, interno in microfibra

CHIFFON POUR LE NETTOYAGE DE LA SELLE

- Fermeture Velcro pour fixation au châssis
- Matériau : extérieur en polyester, intérieur en microfibre

PAÑO PARA LIMPIAR EL SILLÍN

- Cierre en velcro para fijar el paño a la estructura
- Material: exterior en poliéster, interior en microfibra

SATTEL-REINIGUNGSTUCH

- Klettverschluss zur Befestigung am Rahmen
- Material: außen aus Polyester, innen aus Mikrofaser

PACKAGING

carded
L 12 x H 22.5 cm



DISPLAY

material: cardboard
L 13 x H 35.5 x W 26.5 cm

10 PCS

BCKIT1



8 051128 750263



Reflective strip



Soft microfibre

BIKE PHONE HOLDER

L 7.5 x H 13.5 cm

ADJUSTABLE PHONE HOLDER FOR BIKE

- Material: silicone

PORTA CELLULARE PER BICICLETTA REGOLABILE

- Materiale: silicone

SUPPORT RÉGLABLE DE TÉLÉPHONE POUR VÉLO

- Matériau : silicone

SOPORTE DE TELÉFONO MÓVIL REGULABLE PARA BICICLETA

- Material: silikon

EINSTELLBARE HANDYHALTERUNG FÜR FAHRRÄDER

- Material: Silikon

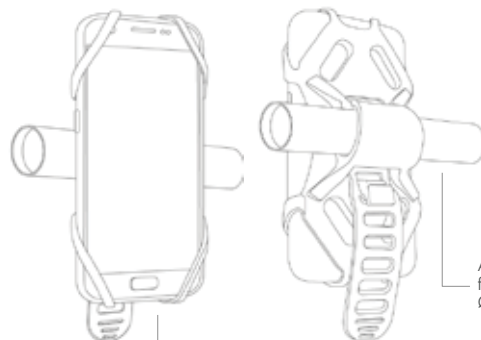

Adjustable:
for handlebars
Ø 15 - 48 mm

Adapts to most smartphones
Screen size: MIN - MAX: 4.7"-6"

PACKAGING

clamshell
L 11 x H 18 x W 5.5 cm

SOLD X 4

BIKE0001



8 052783 617090



BIKE PUMP

Ø 3 cm, L 30 cm

BICYCLE PUMP

- Material: plastic and metal

POMPA PER BICICLETTA

- Materiale: plastica e metallo

POMPE À VÉLO

- Matériau : plastique et métal

BOMBA PARA BICICLETA

- Material: plástico y metal

FAHRRADPUMPE

- Material: Kunststoff und Metall

PACKAGING

cardboard box
L 32 x H 3.6 x W 3.6 cm

DISPLAY

material: cardboard
L 33.5 x H 18 x W 12 cm

9 PCS

PUMKIT1



8 051128 751017



13-IN-1 BIKE MULTI TOOL

L 8.8 x H 2.5 x W 4.5 cm

BIKE MULTI TOOL

- 13 tools in 1 to make repairs or adjustments during bike rides
- Material: beech wood and metal

ATTREZZO MULTIFUNZIONE PER BICICLETTA

- 13 attrezzi in 1 per effettuare riparazioni o regolazioni durante le uscite in bici
- Materiale: legno di faggio e metallo

OUTIL MULTIFONCTION POUR VÉLO

- 13 outils en 1 pour effectuer des réparations ou des réglages pendant les sorties vélo
- Matériau : bois de hêtre et en métal

HERRAMIENTA MULTIFUNCIÓN PARA BICICLETA

- 13 herramientas en 1 para realizar reparaciones o ajustes durante las salidas en bici
- Material: madera de haya y metal

MULTIFUNKTIONSWERKZEUG FÜR FAHRRAD

- 13 Werkzeuge in 1, um beim Fahrradfahren Reparaturen oder Einstellungen vorzunehmen
- Material: Buchenholz und Metall

PACKAGING

carded
L 9.4 x H 17.4 x W 2.7 cm

SOLD X 4

BMT0001



8 052461 962122

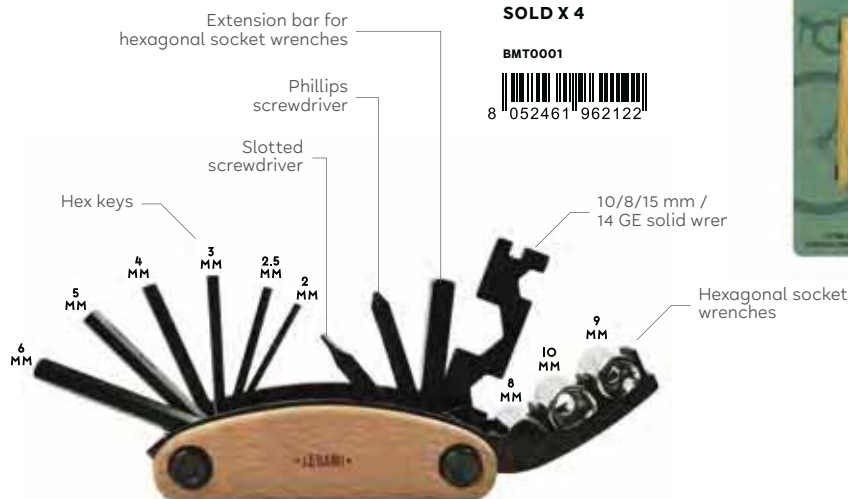

BIKE REPAIR KIT

BICYCLE TYRE REPAIR KIT

- The kit contains: 2 metal levers, 6 assorted patches, 1 x 10 cc tube of rubber cement, 1 scraper, 1 wax crayon, 1 piece of chalk

KIT RIPARAZIONE PER BICICLETTA

- Il kit contiene: 2 leve in metallo, 6 pezze assortite, 1 tubetto mastice 10 cc, 1 raschietto, 1 pastello a cera, 1 gessetto

KIT DE RÉPARATION POUR VÉLO

- Le kit contient : 2 démonte-pneus en métal, 6 rustines assorties, 1 tube de colle de 10 cc, 1 grattoir, 1 pastel à la cire, 1 craie

KIT REPARACIÓN DE BICICLETA

- El kit contiene: 2 palancas de metal, 6 parches variados, 1 tubo de masilla de 10 cc, 1 raspador, 1 lápiz de cera, 1 tiza

FAHRRADREPARATUR-SET

- Das Set enthält: 2 Metallhebel, 6 nach Größen sortierte Flicker, 1 Tube Kitt 10 cc, 1 Schaber, 1 Wachsstift, 1 Kreide

PACKAGING

tin box
L 12.7 x H 2.2 x W 4.2 cm

DISPLAY

material: cardboard
L 13.5 x H 15 x W 18 cm

12 PCS

BRKKIT1



8 051128 751758



BICYCLE CLIPS

L 9 x H 0.8 x W 7 cm

BICYCLE TROUSER CLIPS

- Material: metal and reflective strip

CLIP SALVA PANTALONI

- Materiale: metallo e banda catarifrangente

PINCES PANTALON

- Matériau : métal et bande rétro-réfléchissante

CLIPS SUJETA PANTALONES

- Material: metal y banda reflectante

HOSENKLAMMERN

- Material: Metall und reflektierende Streifen



PACKAGING

carded
L 9.5 x H 14 cm



DISPLAY

material: cardboard
L 22 x H 20.5 x W 10.5 cm
12 PCS

BICKIT1



8 051128 750171



MAGNETIC REFLECTIVE CLIPS

L 7 x H 2 cm (closed)

MAGNETIC REFLECTIVE CLIPS

- Providing visibility in the dark
- Material: PVC

CLIP MAGNETICHE CATARIFRANGENTI

- Consentono di essere visibili al buio
- Materiale: PVC

CLIPS MAGNÉTIQUES RÉTRO-RÉFLÉCHISSANTS

- Permettent d'être vu dans le noir
- Matériau : PVC

CLIPS MAGNÉTICOS REFLECTANTES

- Proporcionan visibilidad en la oscuridad
- Material: PVC

REFLEKTIERENDE MAGNET-CLIPS

- Machen im Dunkeln sichtbar
- Material: PVC



PACKAGING

carded
L 12 x H 12 cm



DISPLAY

material: cardboard
L 13.5 x H 20.5 x W 15.5 cm
7 PCS

REFKIT1



8 051128 750270

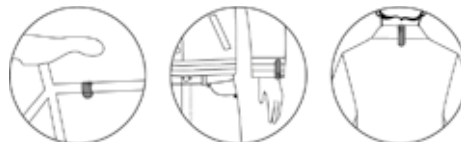

BIKE LIGHT SET

L 3.3 x H 1.2 x W 4 cm (silicone attachment excluded)

SET OF 2 LED LIGHTS FOR BIKES

- Suitable for all sizes of handlebars
- 3 light modes: on, fast flash and slow flash
- Material: silicone

SET DI 2 LUCI LED PER BICI

- Adatto a tutte le misure di manubrio
- 3 modalità di luce: fissa, pulsante veloce e pulsante lento
- Materiale: silicone

SET DE 2 LAMPES À LED POUR VÉLO

- Adapté à toutes les tailles de guidon
- 3 modes d'éclairage : fixe, clignotement rapide et clignotement lent
- Matériau : silicone

SET DE 2 LUCES LED PARA LA BICI

- Adecuado para cualquier medida del manillar
- 3 modalidades de luz: fija, intermitente rápida e intermitente lenta
- Material: silicona

SET AUS 2 LED-LICHTERN FÜR FAHRRÄDER

- Geeignet für alle Lenkergrößen
- 3 Licht-Modi: stetig leuchtend, schnelles und langsames Blinklicht
- Material: Silikon

PACKAGING

PET box
L 8.2 x H 4.8 x W 6.5 cm



DISPLAY

material: cardboard
L 17.5 x H 20 x W 20 cm
12 PCS

SBLKIT1



8 051128 751420



4 x CR2032 batteries (included)



Red rear light

White front light

REAR BIKE LIGHT



L 2 x H 7 x 2.2 W cm
(silicone attachment excluded)

REAR BIKE LIGHT

- Suitable for all sizes of handlebars
- 4 light modes: fixed, slow alternating, flashing, fast alternating
- IP44: splash and rain resistant; dust resistant
- Material: ABS, silicone

LUCE POSTERIORE PER BICI

- Adatta a tutte le misure di manubrio
- 4 modalità di luce: fissa, alternata lenta, lampeggiante, alternata rapida
- IP44: resistente agli schizzi d'acqua e alla pioggia; resistente alla polvere
- Materiale: ABS, silicone

PHARE ARRIÈRE POUR VÉLO

- Adapté à toutes les tailles de guidon
- 4 modes d'éclairage: fixe, clignotement lent, flash, clignotement rapide
- IP44: protégé contre les éclaboussures ou les projections d'eau; résistant à la poussière
- Matériau: ABS, silicone

LUZ TRASERA PARA BICI

- Apta para cualquier medida de manillar
- 4 modos de luz: fija, alterna lenta, intermitente, alterna rápida
- IP44: resistente a las salpicaduras de agua y a la lluvia; resistente al polvo
- Material: ABS, silicona

FAHRRADRÜCKLICHT

- Geeignet für alle Lenkergrößen
- 4 Lichtmodi: Dauerlicht, langsamer Wechsel, Blinken, schneller Wechsel
- IP44: Vor Wasserspritzern und Regen geschützt; Staubgeschützt
- Material: ABS, Silikon

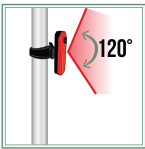

Angle of visibility



Adjustable tilt

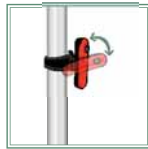

Use both horizontally and vertically

PACKAGING
cardboard box
L 7 x H 8 x W 4.3 cm
SOLD X 6

BLR0001



USB rechargeable.
USB charging cable included



Lumens



Up to 12 hours



Water resistant



FRONT BIKE LIGHT



L 2 x H 7 x 2.2 W cm
(silicone attachment excluded)

FRONT BIKE LIGHT

- Suitable for all sizes of handlebars
- 4 light modes: fixed, slow alternating, flashing, fast alternating
- IP44: splash and rain resistant; dust resistant
- Material: ABS, silicone

LUCE ANTERIORE PER BICI

- Adatta a tutte le misure di manubrio
- 4 modalità di luce: fissa, alternata lenta, lampeggiante, alternata rapida
- IP44: resistente agli schizzi d'acqua e alla pioggia; resistente alla polvere
- Materiale: ABS, silicone

PHARE AVANT POUR VÉLO

- Adapté à toutes les tailles de guidon
- 4 modes d'éclairage: fixe, clignotement lent, flash, clignotement rapide
- IP44: protégé contre les éclaboussures ou les projections d'eau; résistant à la poussière
- Matériau: ABS, silicone

LUZ DELANTERA PARA BICI

- Apta para cualquier medida de manillar
- 4 modos de luz: fija, alterna lenta, intermitente, alterna rápida
- IP44: resistente a las salpicaduras de agua y a la lluvia; resistente al polvo
- Material: ABS, silicona

FAHRRADLICHT

- Geeignet für alle Lenkergrößen
- 4 Lichtmodi: Dauerlicht, langsamer Wechsel, Blinken, schneller Wechsel
- IP44: Vor Wasserspritzern und Regen geschützt; Staubgeschützt
- Material: ABS, Silikon



Angle of visibility



Adjustable tilt



Use both horizontally and vertically

PACKAGING
cardboard box
L 7 x H 8 x W 4.3 cm
SOLD X 6

BLF0001



USB rechargeable.
USB charging cable included



Lumens



Up to 12 hours



Water resistant



BIKE HORN

L 17.5 cm

BICYCLE HORN

• Material: metal, silicone

CAMPANELLO A TROMBETTA PER BICICLETTA

• Materiale: metallo, silicone

KLAXON POUR VÉLO EN FORME DE TROMPETTE

• Matériau : métal, silicone

BOCINA PARA BICICLETA

• Material: metal, silicona

FAHRRADHUPE HORN

• Material: Metall, Silikon



PACKAGING

window box
L 17.5 x H 10.7 x W 6.5 cm

SOLD X 4

BIHA0001



8 056304 485274



BIKE HORN

L 17.5 cm

BICYCLE HORN

• Material: metal, silicone

CAMPANELLO A TROMBETTA PER BICICLETTA

• Materiale: metallo, silicone

KLAXON POUR VÉLO EN FORME DE TROMPETTE

• Matériau : métal, silicone

BOCINA PARA BICICLETA

• Material: metal, silicona

FAHRRADHUPE HORN

• Material: Metall, Silikon

PACKAGING

window box
L 17.5 x H 10.7 x W 6.5 cm

SOLD X 2



BOAT
BIHO0010



8 056304 485212



ICE-CREAM
BIHO0011



8 056304 485229



TRAVEL
BIHO0013



8 056304 485243



LADYBUGS
BIHO0014



8 056304 485250



SPACE
BIHO0016



8 051739 307689



PANDA
BIHO0017



8 051739 307696



TOUCANS
BIHO0018



8 051739 307702



CHERRY
BIHO0019



8 051739 307719



UNICORN
BIHO0020



8 051739 307726

BIKE BELL

Ø 5.5 cm, H 3 cm

BICYCLE BELL

• Material: metal

CAMPANELLO PER BICICLETTA

• Materiale: metallo

SONNETTE POUR VÉLO

• Matériau : métal

TIMBRE PARA BICICLETA

• Material: metal

FAHRRADKLINGEL

• Material: Metall

* While stock lasts

PACKAGING

PET box w/handle

L 7.5 x H 7.5 x W 5.5 cm

SOLD X 2



LADYBUGS
DRI0011



8 051764 521999



OWLS
DRI0012



8 051764 522002



STREET
PIRATE
DRI0017



8 051764 522057



TRAVEL
DRI0027



8 056304 485175



LLAMA
DRI0028



8 051739 307634



SPACE
DRI0029



8 051739 307641



HUG ME
DRI0030



8 051739 307658



BEE
DRI0031



8 051739 307665



TOUCANS
DRI0032 *



8 051739 307672

L.O.L.

COLLECTION



ANTI-STRESS FORMULA

ANTI-STRESS BALL

• Material: latex, maltose

PALLINA ANTISTRESS

• Materiale: lattice, maltosio

BALLE ANTI-STRESS

• Matériau : latex, maltose

PELOTA ANTIESTRÉS

• Material: látex, maltosa

KLEINER ANTI-STRESS-BALL

• Material: Latex, Maltose

✳ *While stock lasts*

SOLD X 2



PACKAGING
clamshell
L 11.5 x H 19 x W 4.8 cm

FOOTBALL
STRES0001



PACKAGING
clamshell
L 11.5 x H 19 x W 4.8 cm

BASKETBALL
STRES0002



PACKAGING
clamshell
L 11.5 x H 19 x W 4.8 cm

TENNIS BALL
STRES0003



PACKAGING
clamshell
L 11.5 x H 19 x W 4.8 cm

BASEBALL
STRES0004



PACKAGING
clamshell
L 11.5 x H 19.5 x W 6 cm

RUGBY BALL
STRES0005 ✳



PACKAGING
clamshell
L 13.3 x H 20.3 x W 4.3 cm

VOODOO BOSS
STRES0006



PACKAGING
clamshell
L 13.3 x H 20.3 x W 4.3 cm

VOODOO EX
STRES0007



PACKAGING
clamshell
L 14.5 x H 26 x W 6.5 cm

BANANA
STRES0008



PACKAGING
clamshell
L 11.5 x H 18.5 x W 6 cm

8 BALL
STRES0009



PACKAGING
clamshell
L 11.3 x H 19 x W 5 cm

POO
STRES0010



PACKAGING
clamshell
L 11 x H 16.3 x W 3.5 cm

HEART
STRES0011



DO NOT DISTURB

Ø 10 cm, L 10 cm

SUDOKU TOILET ROLL

CARTA IGIENICA SUDOKU

PAPIER TOILETTE SUDOKU

PAPEL HIGIÉNICO CON SUDOKU

SUDOKU-TOILETTENPAPIER

PACKAGING
cardboard box
L 11 x H 11 x W 11 cm
SOLD X 4

TR0001



DO NOT CROSS

Ø 10 cm, L 10 cm

CRIME SCENE TOILET ROLL

CARTA IGIENICA SCENA DEL CRIMINE

PAPIER TOILETTE SCÈNE DE CRIME

PAPEL HIGIÉNICO ESCENA DEL CRIMEN

KRIMI-TOILETTENPAPIER

PACKAGING
cardboard box
L 11 x H 11 x W 11 cm
SOLD X 4

TR0002



MULTI VOICE CHANGER



L 7 x H 7 x W 4.5 cm

MINI VOICE CHANGER MEGAPHONE

- 4 different sound effects
- Material: plastic

MINI MEGAFONO CAMBIA VOCE

- 4 effetti sonori diversi
- Materiale: plastica

MINI MÉGAPHONE MODIFICATEUR DE VOIX

- 4 effets sonores différents
- Matériau : plastique

MINIMEGÁFONO CAMBIADOR DE VOZ

- 4 efectos sonoros diferentes
- Material: plástico

MINI-MEGAFON MIT STIMMVERZERRER

- 4 verschiedene Geräusche
- Material: Kunststoff

 1 x 23A battery
(included for the use
of the "try me" function)



PACKAGING

carded
L 11.5 x H 15 x W 4.6 cm

SOLD X 6

SVC0001



DECISION MAKER

L 14.5 x H 21.5 x W 10 cm

MAGNETIC PENDULUM

- With 6 possible answers
- Material: plastic, metal, magnetic base

PENDOLO MAGNETICO

- Con 6 possibili risposte
- Materiale: plastica, metallo, base magnetica

PENDULE MAGNÉTIQUE

- Avec 6 réponses possibles
- Matériau : plastique, métal, base magnétique

PÉNDULO MAGNÉTICO

- Con 6 respuestas posibles
- Material: plástico, metal, base magnética

MAGNETISCHES PENDEL

- Mit 6 möglichen Antworten
- Material: Kunststoff, Metall, Magnetbasis



PACKAGING

cardboard box
L 11.8 x H 20.4 x W 3 cm



DISPLAY

material: cardboard
L 24 x H 27.5 x W 21.5 cm

10 PCS

DMKIT2



YES & NO

Ø 8.8 cm, H 3.5 cm

SET OF TWO SOUND BUTTONS

- 10 different sound variations for each button
- Material: ABS

SET DI DUE PULSANTI SONORI

- 10 diverse varianti sonore per ogni pulsante
- Materiale: ABS

SET DE DEUX BOUTONS SONORES

- 10 variantes sonores différentes pour chaque bouton
- Matériau : ABS

  2 x AAA batteries
(included)

SET DE DOS BOTONES SONOROS

- 10 variedades sonoras para cada botón
- Material: ABS

SET MIT ZWEI BUZZERN

- 10 verschiedene Töne für jeden Buzzer
- Material: ABS

PACKAGING

cardboard box
L 19 x H 9.5 x W 4.7 cm

SOLD X 4

SBS0001



KNOCKOUT

L 18 x H 35 x W 18 cm

TABLETOP PUNCHING BAG

- Suction cup base
- Air pump included
- Material: iron, PU

PUNGIBALL DA TAVOLO

- Base a ventosa
- Pompetta ad aria inclusa
- Materiale: ferro, PU

PUNCHING-BALL DE TABLE

- Socle à ventouse
- Petite pompe à air incluse
- Matériau : fer, PU

PUNCHING BALL DE MESA

- Base con ventosa
- Bomba de aire incluida
- Material: hierro, PU

TISCH-BOXBIRNE

- Basis mit Saugnapf
- Luftpumpe inbegriffen
- Material: Eisen, PU



PACKAGING

cardboard box
L 21 x H 19.5 x W 10.7 cm

SOLD X 4

MIPB0001



MAGIC SHOT



L 22.8 x H 27.5 x W 18.5 cm (open)
Hoop diameter: 14 cm

BASKETBALL HOOP FOR WASTE BIN WITH SOUND EFFECT

- Turn your waste bin into a mini basketball hoop
- The basketball hoop reproduces the sound effect of a cheering crowd after each shot
- Material: ABS, PP

CANESTRO SONORO PER CESTINO

- Trasforma il cestino in un piccolo canestro
- Il canestro riproduce l'effetto sonoro della folla che acclama dopo ogni centro
- Materiale: ABS, PP

PANIER SONORE POUR CORBEILLE

- Transformez la corbeille en un petit panier
- Le panier reproduit l'effet sonore de la foule qui acclame après chaque tir réussi
- Matériau : ABS, PP

CANASTA SONORA PARA PAPELERA

- Transforma la papelera en una pequeña canasta
- La canasta reproduce el sonido de la multitud que vitorea después de haber encestado
- Material: ABS, PP

BASKETBALLKORB MIT GERÄUSCH FÜR DEN MÜLLEIMER

- Verwandeln Sie Ihren Mülleimer in einen Basketballkorb
- Der Basketballkorb gibt das Geräusch eines Beifall spendenden Publikums nach jedem Treffer wieder
- Material: ABS, PP

PACKAGING

cardboard box
L 20 x H 24 x W 6.5 cm

SOLD X 4

BKH0001

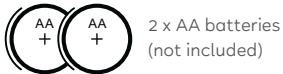

Back clip: easily attaches to any waste bin with a flat edge



Vintage memories

COLLECTION



MINI BALL SET

L 12 x H 3.7 x W 8.6 cm

SET OF 3 MINI BALLS

- American football, basketball and football
- Material: plastic

SET DI 3 MINI PALLONI

- Football americano, basket e calcio
- Materiale: plastica

SET DE 3 MINI BALLONS

- Football américain, basket et foot
- Matériau : plastique

SET DE 3 MINI BALONES

- Fútbol americano, baloncesto y fútbol
- Material: plástico

SET AUS 3 MINI-BÄLLEN

- Amerikanischer Football, Basketball und Fußball
- Material: Kunststoff

PACKAGING

clamshell
L 28 x H 23.5 x W 12 cm

SOLD X 2

BS0001



8 052783 613115



Football: Ø 12 cm



American football:
Ø 9.5 cm, L 15.5 cm

Basketball: Ø 12 cm

FLYING DISK

Ø 27.5 cm, H 3 cm

FLYING DISK

- Material: plastic

DISCO VOLANTE

- Materiale: plastica

DISQUE-VOLANT

- Matériau : plastique

DISCO VOLADOR

- Material: plástico

FLUGSCHEIBE

- Material: Kunststoff

PACKAGING

window box
L 27.6 x H 31 x W 3.2 cm

SOLD X 4

DISC0001



8 052783 614129



METAL DETECTOR

L 13 x H 31.5 x W 4 cm

METAL DETECTOR

- Adjustable sensitivity level
- Adjustable detection base plate
- Material: plastic

CERCAMETALLI

- Livello di sensibilità regolabile
- Piatto base di rilevamento regolabile
- Materiale: plastica

DÉTECTEUR DE MÉTAUX

- Niveau de sensibilité réglable
- Plateau de base de détection réglable
- Matériau : plastique

DETECTOR DE METALES

- Nivel de sensibilidad regulable
- Plato base de detección regulable
- Material: plástico

METALLSUCHER

- Einstellbares Empfindlichkeitsniveau
- Einstellbarer Suchteller
- Material: Kunststoff

PACKAGING

cardboard box
L 32.5 x H 14.5 x W 5 cm

SOLD X 2

MD0001



8 052783 614068



2 x AA batteries
(not included)

TUMBLING TOWER

L 7.4 x H 23.3 x W 7.4 cm

TUMBLING TOWER GAME

- Contents: 48 blocks and cardboard support to hold the tower inside the box
- Material: wood

IL GIOCO DELLA TORRE TRABALLANTE

- Contenuto: 48 mattoncini e supporto di cartoncino per sistemare la torre all'interno della scatola
- Materiale: legno

LE JEU DE LA TOUR INFERNALE

- Contient : 48 briques et support en carton pour ranger la tour à l'intérieur de la boîte
- Matériau : bois

EL JUEGO DE LA TORRE TAMBALEANTE

- Contenido: 48 piezas y soporte de cartón para colocar la torre dentro de la caja
- Material: madera

DAS SPIEL DES WACKELIGEN TURMS

- Inhalt: 48 Klötze und Kartonunterlage, um den Turm in der Schachtel zu platzieren
- Material: Holz

PACKAGING
cardboard box
L 8.4 x H 24 x
W 8.4 cm

SOLD X 2

TOW0001



8 056304 486233



JUGGLING BALLS

Ø 6.5 cm

JUGGLING BALLS

- Set of 3 juggling balls
- Material: PU-coated and filled with plastic beads

PALLINE DA GIOCOLIERE

- Set 3 palline giocoleria
- Materiale: rivestite in PU e riempite di grani in plastica

BALLES DE JONGLAGE

- Set de 3 balles de jonglage
- Matériau : revêtues de PU et remplies de grains en plastique

PELOTAS DE MALABARES

- Set de 3 pelotas de malabares
- Material: revestimiento en PU y relleno con granos de plástico

JONGLIERBÄLLE

- Set aus 3 Jonglierbällen
- Material: PU-beschichtet und mit Kunststoff-Perlen gefüllt

PACKAGING

window box
L 6.5 x H 18.5 x W 6.5 cm



DISPLAY

material: cardboard
L 13.8 x H 19.3 x
W 20.3 cm

6 PCS

JUGKIT1



8 051128 751499



DOMINOES

L 4.7 x H 2.4 cm (tile size)

DOMINOES

- Contents: 28 tiles
- Material: plastic

DOMINO

- Contenuto: 28 tessere
- Materiale: plastica

DOMINOS

- Contient 28 pièces
- Matériau : plastique

DOMINÓ

- Contenido: 28 fichas
- Material: plástico

DOMINO

- Inhalt: 28 Spielsteine
- Material: Kunststoff

PACKAGING

tin box with paper wrap
L 17.5 x H 3.7 x W 5.3 cm



DISPLAY

material: cardboard
L 18.5 x H 18.5 x
W 18 cm

6 PCS

DOMKIT1



8 051128 751383



PLAYING CARDS

L 6.2 x H 8.8 cm

PLAYING CARDS

- 2 sets of 54 playing cards
- 100% waterproof
- Material: PVC

CARTE DA GIOCO

- 2 mazzi da 54 carte
- Impermeabili al 100%
- Materiale: PVC

CARTES À JOUER

- 2 jeux de 54 cartes
- Entièrement imperméables
- Matériau : PVC

CARTAS

- 2 barajas de 54 cartas
- 100 % impermeables
- Material: PVC

SPIELKARTEN

- Doppeldeck-Karten mit jeweils 54 Karten
- 100% wasserfest
- Material: PVC

PACKAGING

tin box
L 13 x H 3.7 x W 10.2 cm



DISPLAY

material: cardboard
L 14 x H 23 x W 21 cm

6 PCS

PLAKIT1



8 051128 751680



DESK BELL

Ø 8.5 cm, H 6 cm

DESK BELL

- Material: chrome with black metal base

CAMPANELLO DA TAVOLO

- Materiale: metallo cromato con base nera in metallo

CLOCHETTE DE TABLE

- Matériau : métal chromé avec base noire en métal

TIMBRE DE MESA

- Material: metal cromado con base negra de metal

TISCHKLINGEL

- Material: Verchromtes Metall mit schwarzer Metallbasis

PACKAGING

window box
L 9 x H 8.5 x W 9.5 cm

SOLD X 4

DB0001



8 056304 485267



WHOOPEE CUSHION

Ø 15 cm

WHOOPEE CUSHION

- Self-inflating
- Material: rubber

CUSCINO SCOREGGINO

- Autogonfiante
- Materiale: gomma

COUSSIN PÉTEUR

- Autogonflant
- Matériau : caoutchouc

COJÍN TIRAPEDOS

- Autoinflable
- Material: goma

PUPSKISSEN

- Selbstaufblasend
- Material: Gummi

PACKAGING

cardboard box
L 13.3 x H 17 x W 4.3 cm

SOLD X 4

WH0001



8 052783 614181



MAGIC SPRING

Ø 6.7 cm, H 7 cm

SPRING TOY

- Material: galvanised steel

IL GIOCO DELLA MOLLA

- Materiale: acciaio zincato

LE RESSORT MAGIQUE

- Matériau : acier zingué

MUELLE DE JUGUETE

- Material: acero cincado

DAS SPIRALSPIEL

- Material: verzinkter Stahl

PACKAGING

cardboard box
L 7 x H 7.2 x W 7 cm

DISPLAY

material: cardboard
L 15 x H 28 x W 22.5 cm

12 PCS

SLKIT1



8 051128 751550



COMPASS

Ø 4.4 cm, H 1 cm

COMPASS KEY RING

- Material: aluminium, with a magnet and transparent dial

BUSSOLA PORTACHIAVI

- Materiale: alluminio, con magnete e quadrante trasparente

PORTE-CLÉS BOUSSE

- Matériau : aluminium, avec aimant et cadran transparent

BRÚJULA-LLAVERO

- Material: aluminio, con imán y esfera transparente

KOMPASS-SCHLÜSSELANHÄNGER

- Material: Aluminium, mit Magnet und transparentem Kompassquadranten

PACKAGING

cardboard box
L 5.7 x H 4.8 x W 1.5 cm

DISPLAY

material: cardboard
L 13 x H 14.5 x W 11 cm

16 PCS

CMKIT1



8 051128 750621



NEWTON'S CRADLE

L 9 x H 9 x W 7.5 cm

NEWTON'S CRADLE

- Material: ABS, steel

PENDOLO DI NEWTON

- Materiale: ABS, acciaio

PENDULE DE NEWTON

- Matériau : ABS, acier

PÉNDULO DE NEWTON

- Material: ABS, acero

NEWTONPENDEL

- Material: ABS, Stahl



PACKAGING

cardboard box
L 7.8 x H 11 x W 3 cm



DISPLAY

material: cardboard
L 16.5 x H 18.5 x W 15 cm

10 PCS

NCKIT1



PIN ART

L 12.5 x H 18 x W 4.5 cm

THREE-DIMENSIONAL IMPRINTS

- Material: plastic, steel

IMPRONTE TRIDIMENSIONALI

- Materiale: plastica, acciaio

EMPREINTES 3D

- Matériau : plastique, acier

IMÁGENES TRIDIMENSIONALES

- Material: plástico, acero

DREIDIMENSIONALE ABDRÜCKE

- Material: Kunststoff, Stahl



PACKAGING

cardboard box
L 13.5 x H 18.5 x W 5 cm

SOLD X 4

ART0001



MAGIC CUBE

L 5.8 x H 5.8 x W 5.8 cm

MAGIC CUBE

- Smooth-gliding movements
- Durable structure
- Material: plastic

CUBO MAGICO

- Movimenti scorrevoli
- Struttura resistente
- Materiale: plastica

CUBE MAGIQUE

- Mouvements très fluides
- Structure résistante
- Matériau : plastique

CUBO MÁGICO

- Movimientos fluidos
- Estructura resistente
- Material: plástico

MAGISCHER WÜRFEL

- Gleitende Bewegungen
- Widerstandsfähige Struktur
- Material: Kunststoff

APPROVED BY

Rubik's®

PACKAGING:

window box
L 9.5 x H 13 x W 6.7 cm

SOLD X 4

CUBE0001



GLASS MARBLES

Ø 1.7 cm - Ø 2.5 cm

GLASS MARBLES

- Contains 20 player marbles + 1 shooter marble
- Material: glass

BIGLIE IN VETRO

- Contiene 20 biglie + 1 biglione
- Materiale: vetro

BILLES EN VERRE

- Contient 20 billes + 1 calot
- Matériau : verre

CANICAS DE VIDRIO

- Contiene 20 canicas + 1 bolón
- Material: vidrio

GLASMURMELN

- Enthält 20 kleine Murmeln + 1 große Murmel
- Material: Glas

PACKAGING

tin box
L 8 x H 10.8 x W 2.5 cm



DISPLAY

material: cardboard
L 16.5 x H 21.5 x W 18 cm

12 PCS

GMKIT1



8 051128 754346



MINI PINBALL

L 17.7 x H 29 x W 1.8 cm

PORTABLE PINBALL

- Material: plastic

FLIPPER PORTATILE

- Materiale: plastica

FLIPPER PORTABLE

- Matériau : plastique

PINBALL PORTÁTIL

- Material: plástico

TRAGBARER FLIPPERAUTOMAT

- Material: Kunststoff



PBG0002



8 059174 833299

PACKAGING

window box
L 18 x H 32 x W 2 cm

SOLD X 4



HOBBY HORSE

H 80 cm (horn included)

UNICORN HOBBY HORSE / HOBBY HORSE WITH SOUND

- By pressing the ears, the unicorn / horse emits a galloping and neighing sound
- Material: polyester, plastic

UNICORNO / CAVALLUCCIO SONORO CON ASTA

- Premendo le orecchie, l'unicorno / il cavallo emette il suono del galoppo e del nitrito
- Materiale: poliester, plastica

LICORNE / CHEVAL BÂTON SONORE

- En appuyant sur les oreilles, la licorne / le cheval émet le son du galop et du hennissement
- Matériau : polyester, plastique

UNICORNIO / CABALLITO SONORO DE PALO

- Apretando las orejas, el unicornio / caballo hace el sonido del galope y del relincho
- Material: poliéster, plástico

STECKENEINHORN / STECKENPFERD MIT SOUND

- Werden die Ohren gedrückt, so gibt das Einhorn / Pferd Galopp und Gewieher wieder
- Material: Polyester, Kunststoff



DISPLAY

material: cardboard
L 40 x H 80 x W 40 cm

6 PCS

HHKIT1



8 051128 754353



DISPLAY

material: cardboard
L 40 x H 80 x W 40 cm

6 PCS

HHKIT2



8 051128 754360

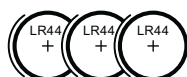

3 x LR44 batteries
(included, non-replaceable)

2-IN-1 CHESS & DRAUGHTS

L 28.2 x H 1.5 x W 28.7 cm (open)

CHESS AND DRAUGHTS

- Easy and secure closure, the pieces can be placed back inside the board at the end of the game
- Material: pine wood

SCACCHI E DAMA

- Chiusura facile e sicura, i pezzi si possono riporre all'interno della scacchiera al termine del gioco
- Materiale: legno di pino

ÉCHECS ET DAMES

- Fermeture facile et sûre, les pièces peuvent être remises à l'intérieur de l'échiquier à la fin du jeu
- Matériau : bois de pin

AJEDREZ Y DAMAS

- Cierre fácil y seguro, las piezas se pueden meter dentro del tablero al final del juego
- Material: madera de pino

SCHACH UND DAME

- Einfaches und sicheres Schließen, die Figuren lassen sich nach Spielende im Inneren des Schachbrettes verstauen
- Material: Kiefernholz

PACKAGING

cardboard box
L 28.7 x H 15.5 x W 3.5 cm

SOLD X 4

CD0001

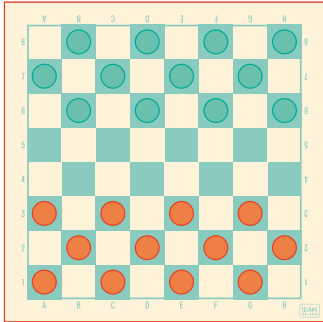
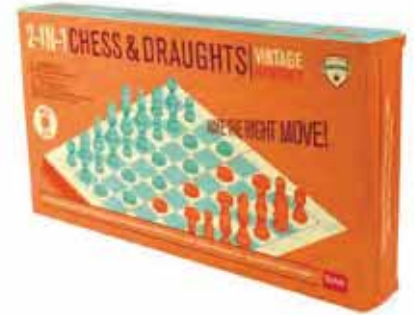

12 pcs each colour

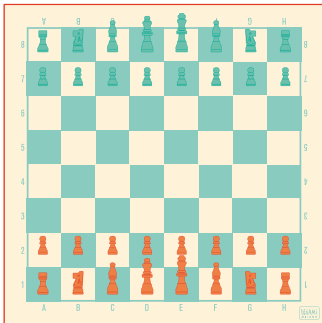

16 pcs each colour



FSC®
CERTIFIED WOOD

The mark of
responsible forestry

15 PUZZLE

L 10 x H 2 x W 10 cm

15 PUZZLE

- Number puzzle with tiles from 1 to 15
- Material: beechwood

PUZZLE DEL 15

- Rompicapo numerico con tessere da 1 a 15
- Materiale: legno di faggio

JEU DE TAQUIN

- Casse-tête numérique avec des pions de 1 à 15
- Matériau : bois de hêtre

JUEGO DEL 15

- Rompecabezas numérico con fichas del 1 al 15
- Material: madera de haya

15-PUZZLE

- Zahlen-Knobelspiel mit Plättchen von 1 bis 15
- Material: Buchenholz



PACKAGING

cardboard box
L 10.3 x H 13.8 x W 2.5 cm

SOLD X 4

FIPO001



8 059174 833121



The mark of responsible forestry

FSC®
CERTIFIED WOOD



TIDDLYWINKS

L 15.3 x H 4.5 x W 15.3 cm

TIDDLYWINKS

- Material: plastic, paper

GIOCO DELLE PULCI

- Materiale: plastica, carta

JEU DE PUCES

- Matériau : plastique, papier

JUEGO DE LA PULGA

- Material: plástico, papel

FLOHSPIEL

- Material: Kunststoff, Papier



PACKAGING

cardboard box
L 15.3 x H 15.3 x W 4.5 cm

SOLD X 4

TID0001



8 052783 619148

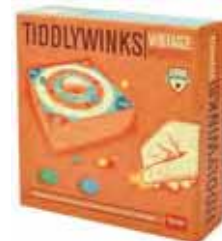

FOUR IN A LINE

L 24.8 x H 17.3 x W 17.5 cm (open)

4 IN A LINE

- The game board turns into a handy lid
- Material: wood

4 IN LINEA

- La tavola da gioco diventa un comodo coperchio
- Materiale: legno

4 EN LIGNE

- La grille de jeu devient un couvercle pratique
- Matériau : bois

4 EN LÍNEA

- El tablero de juego se convierte en una práctica tapadera
- Material: madera

4 IN EINER REIHE

- Das Spielbrett wird zu einem bequemen Deckel
- Material: Holz

PACKAGING

cardboard box
L 26 x H 18.5 x W 5 cm

SOLD X 2

FOUR0001



8 051739 306842



Open

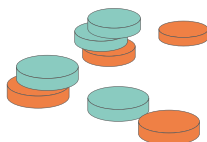

21 pcs each colour



Closed

MEMORY



L 6.4 X H 6.4 X W 2 cm

LIGHT AND SOUND MEMORY GAME

- Material: plastic

GIOCO DI MEMORIA LUMINOSO E SONORO

- Materiale: plastica

JEU DE MÉMOIRE LUMINEUX ET SONORE

- Matériau : plastique

JUEGO DE MEMORIA CON LUCES Y SONIDO

- Material: plástico

GEDÄCHTNISPIEL MIT LICHT UND SOUND

- Material: Kunststoff



3 x LR44 batteries
(included)



With lights and sound

PACKAGING

carded

L 10.3 x H 13 x W 2.3 cm



DISPLAY

material: cardboard

L 12 x H 13.5 x W 18.3 cm

8 PCS

MEZKIT1



8 051128 755527



YO-YO

Ø 6 cm, H 2.8 cm

YO-YO

- With clutch and lights
- Material: plastic

YO-YO

- Con frizione e luci
- Materiale: plastica

YO-YO

- Avec embrayage et lumières
- Matériau : plastique

YOYÓ

- Con embrague y luces
- Material: plástico

JO-JO

- Mit Kupplung und Lichtern
- Material: Kunststoff



1 x LR41 battery
(included, non-replaceable)



PACKAGING

window box

L 10 x H 11 x W 4.5 cm

SOLD X 4

YOY0001



8 052783 615621



KITE

L 58 x H 68 cm (open, tail excluded)

DIAMOND KITE

- Material: polyester, metal, fabric, metal frame, plastic handle

AQUILONE

- Materiale: poliestere, tessuto, struttura in metallo, manico in plastica

CERF-VOLANT

- Matériau : polyester, tissu, structure en métal, poignée en plastique

COMETA

- Material: poliéster, metal, tejido, estructura metálica, mando de plástico

FLUGDRACHEN

- Material: Polyester, Metall, Stoff, Gestell aus Metall, Plastikgriff



Line length: 30 m

PACKAGING

cardboard box

L 9 x H 68.5 x W 6 cm

SOLD X 4

KI0001



8 051739 306781

Polyester bag
included



MAGNIFYING GLASS

L 13.5 x H 1.4 x W 6.5 cm

3X MAGNIFYING GLASS

- Enlarges objects 3 times
- Material: plastic, glass

LENTE DI INGRANDIMENTO 3X

- Ingrandisce 3 volte gli oggetti osservati
- Materiale: plastica, vetro

LOUPE GROSSISSANTE 3X

- Grossit 3 fois les objets observés
- Matériau : plastique, verre

LUPA DE AUMENTO 3X

- Aumenta 3 veces los objetos observados
- Material: plástico, vidrio

LUPE MIT 3X-VERGRÖßERUNG

- Macht die betrachteten Gegenstände 3-mal größer
- Material: Kunststoff, Glas

PACKAGING

carded
L 12.5 x H 16.5 cm



DISPLAY

material: cardboard
L 14 x H 27.5 x W 18.5 cm

10 PCS

MAGNKIT1



8 051128 750195



MICROSCOPE

L 2.5 x H 10 x W 5 cm

PORTABLE MICROSCOPE WITH LED ILLUMINATION

- Package contents: portable microscope, removable base, 2 plastic slides, instruction manual
- Material: plastic

MICROSCOPIO PORTATILE CON ILLUMINAZIONE LED

- Contenuto della confezione: microscopio portatile, base removibile, 2 vetrini in plastica, manuale d'uso
- Materiale: plastica

MICROSCOPE PORTATIF AVEC ÉCLAIRAGE LED

- Contenu de la boîte : microscope portatif, base amovible, 2 lames en plastique, mode d'emploi
- Matériau : plastique

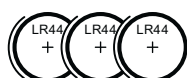

3 x LR44 batteries (included)

MICROSCOPIO PORTÁTIL CON ILUMINACIÓN LED

- Contenido de la caja: microscopio portátil, base desmontable, 2 portaobjetos de plástico, manual de instrucciones
- Material: plástico

TRAGBARES MIKROSKOP MIT LED-BELEUCHTUNG

- Inhalt der Verpackung: tragbares Mikroskop, abnehmbare Basis, 2 Objektträger aus Kunststoff, Gebrauchsanweisung
- Material: Kunststoff

PACKAGING

window box
L 13 x H 17 x W 4 cm

SOLD X 4

MS0001



8 051122 265411



LED illumination button

Adjustable zoom 20x - 40x

Focus adjustment lever

BINOCULARS

L 8.6 x H 3.7 x W 12 cm

BINOCULARS

- Binoculars with 30 mm glass lenses and centralised focus adjustment
- Magnification: 4x
- Material: plastic, glass, fabric

BINOCOLO

- Binocolo con lenti in vetro da 30 mm e funzionalità centralizzata di messa a fuoco
- Ingrandimento: 4x
- Materiale: plastica, vetro, tessuto

JUMELLES

- Jumelles avec lentilles en verre de 30 mm et système centralisé de mise au point
- Agrandissement : 4x
- Matériau : plastique, verre, tissu

PRISMÁTICOS

- Prismáticos con lentes de vidrio de 30 mm y función de enfoque centralizada
- Aumento: 4x
- Material: plástico, vidrio, tejido

FERNGLAS

- Fernglas mit 30 mm dicken Glaslinsen und zentralisierter Scharfeinstellungsfunktion
- Vergrößerung: 4x
- Material: Kunststoff, Glas, Stoff

PACKAGING

cardboard box
L 12 x H 9.8 x W 5 cm

SOLD X 4

BIN0001



8 051122 265138



WHISTLE

L 4.2 x H 2.2 x W 1.8 cm

METAL WHISTLE

- Material: metal, plastic, fabric lanyard

FISCHIETTO IN METALLO

- Materiale: metallo, plastica, cordino in tessuto

SIFFLET EN MÉTAL

- Matériau : métal, plastique, cordon en tissu

SILBATO DE METAL

- Material: metal, plástico, cuerda en tejido

TRILLERPFEIFE AUS METALL

- Material: Metall, Kunststoff, Stoffkordel

PACKAGING

cardboard box
L 6.5 x H 4.5 x W 3.5 cm



DISPLAY

material: cardboard
L 14 x H 17 x W 15 cm

12 PCS

WHISKIT1



HARMONICA

L 10.2 x H 2 x W 3 cm

DIATONIC HARMONICA IN THE KEY OF C

- With 10 holes that allow you to make 20 different sounds
- Material: metal, plastic

ARMONICA DIATONICA IN CHIAVE DI DO (C)

- Con 10 fori che permettono di emettere 20 diversi suoni
- Materiale: metallo, plastica

HARMONICA DIATONIQUE EN CLÉ DE DO (C)

- Avec 10 trous qui permettent d'émettre 20 sons différents
- Matériau : métal, plastique

HARMÓNICA DIATÓNICA EN CLAVE DE DO (C)

- Con 10 celdas que permiten emitir 20 sonidos distintos
- Material: metal, plástico

DIATONISCHE HARMONIKA IN DER TONART C

- Mit 10 Löchern, mit denen 20 unterschiedliche Töne erzeugt werden können
- Material: Metall, Kunststoff

PACKAGING

cardboard box
L 12.5 x H 3.5 x W 4.5 cm



Plastic case
L 11.2 x H 3 x W 4.5 cm

DISPLAY

material: cardboard
L 12.5 x H 18.5 x W 19.5 cm

8 PCS

HARKIT1



Metal shell

RECORDER

Ø 3 cm, L 32.5 cm

RECORDER

- Descant recorder in the key of C
- 8-hole recorder with German fingering
- The packaging contains: 1 descant recorder made of ABS, 1 rod for cleaning the recorder, 1 fabric sleeve
- Material: ABS, fabric

FLAUTO

- Flauto soprano in do (C)
- Flauto dolce 8 fori a diteggiatura tedesca
- La confezione contiene: 1 flauto dolce soprano in ABS, 1 asticella per la pulizia del flauto, 1 fodero in tessuto
- Materiale: ABS, tessuto

FLÛTE

- Flûte soprano en do (C)
- Flûte à bec 8 trous, doigté allemand
- L'emballage contient : 1 flûte à bec soprano en ABS, 1 bâtonnet pour le nettoyage de la flûte, 1 fourreau en tissu
- Matériau : ABS, tissu

FLAUTA

- Flauta soprano en do (C)
- Flauta dulce 8 orificios - digitación alemana
- El kit contiene: 1 flauta dulce soprano de ABS, 1 escobilla para limpiar la flauta, 1 funda en tejido
- Material: ABS, tejido

FLÖTE

- Sopranflöte in C
- Blockflöte mit 8 Grifflöchern und deutschem Fingersatz
- Die Packung enthält: 1 Blockflöte aus ABS, 1 Stab für die Reinigung der Flöte, 1 Stofftuch
- Material: ABS, Stoff

PACKAGING

cardboard box
L 33 x H 3.5 x W 3.5 cm



DISPLAY

material: cardboard
L 35 x H 19.5 x W 11.6 cm

9 PCS

FLTKIT1



SOUND MACHINE

L 6 x H 10 x W 2 cm

SOUND MACHINE WITH FUN SOUND EFFECTS

- 20 sound effects
- Material: ABS, silicone

GIOCO CON EFFETTI SONORI DIVERTENTI

- 20 effetti sonori
- Materiale: ABS, silicone

MACHINE AUX AMUSANTS EFFETS SONORES

- 20 effets sonores
- Matériau : ABS, silicone



3 x LR44 batteries (included, for the use of the "try me" function)

MÁQUINA CON DIVERTIDOS EFECTOS SONOROS

- 20 efectos sonoros
- Material: ABS, silicona

GERÄUSCH-GENERATOR MIT LUSTIGEN GERÄUSCHEN

- 20 Geräusche
- Material: ABS, Silikon



PACKAGING

carded
L 11.5 x H 18 x W 2 cm

SOLD X 4

SM0001



8 059174 833350



MINI FM RADIO

L 8.8 x H 7.5 x W 4.5 cm

MINI PORTABLE RADIO

- FM band from 88 MHz to 108 MHz
- Automatic channel searching
- Reset function
- Material: metal, ABS

MINI RADIO PORTATILE

- Banda FM da 88 MHz a 108 MHz
- Scansione automatica
- Funzione Reset
- Materiale: metallo, ABS

MINI RADIO PORTABLE

- Bande FM de 88 MHz à 108 MHz
- Balayage automatique
- Fonction Reset
- Matériau : métal, ABS

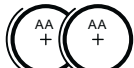

2 x AA batteries (not included)

MINI RADIO PORTÁTIL

- Banda FM de 88 MHz a 108MHz
- Búsqueda de canales auto mática
- Función Reset
- Material: metal, ABS

TRAGBARES MINI-RADIO

- FM-Band zwischen 88 und 108 MHz
- Automatische Scan-Funktion
- Reset-Funktion
- Material: Metall, ABS

Telescopic antenna for better reception



PACKAGING

window box
L 10.2 x H 10.7 x W 5.5 cm

SOLD X 3

FM0001



8 051122 260935



MUSIC BOX

L 3.3 x H 8 x W 2.5 cm

MUSIC BOX

- MDF base

CARILLON A MANOVELLA

- Base in MDF

BOÎTE À MUSIQUE À MANIVELLE

- Base en MDF

CARILLÓN DE MANIVELA

- Base de MDF

KURBEL-SPIELUHR

- MDF-Basis

INDIVIDUAL DESIGNS: SOLD X 5

PACKAGING

cardboard box
L 4 x H 8 x W 2.5 cm



EMPTY DISPLAY ON DEMAND

material: metal
L 23 x H 42 x W 15 cm
minimum order qty: 50 pcs

DISSONG



8 052783 618097

STARTER KIT 50 PCS: 5 X SONG

SONGKIT2



8 051128 753141



LA VIE EN ROSE

SONG0001



8 052783 617977

FOR ELISE

SONG0002



8 052783 617984

MOON RIVER

SONG0003



8 052783 617991

YOU ARE MY SUNSHINE

SONG0004



8 052783 618004

FOUR SEASONS

SONG0005



8 052783 618011

REALITY

SONG0006



8 052783 618028

WHAT A WONDERFUL WORLD

SONG0007



8 052783 618035

MY WAY

SONG0008



8 052783 618042

HAPPY BIRTHDAY

SONG0009



8 052783 618059

IMAGINE

SONG0011



8 052783 618073

MINI WATER GAME

L 17 x H 7.5 x W 1 cm

MINI WATER GAME

- Material: plastic, water

MINI GIOCO AD ACQUA

- Materiale: plastica, acqua

MINI JEU À EAU

- Matériau : plastique, eau

MINIJUEGO DE AGUA

- Material: plástico, agua

MINI-WASSERSPIEL

- Material: Kunststoff, Wasser



No batteries
needed

PACKAGING

window box
L 17.3 x H 10 x
W 1.5 cm

SOLD X 6

WG0001



8 052461 962313



POCKET ARCADE GAME

L 3.5 x H 5.5 x W 1.5 cm

MINI PORTABLE CONSOLE

- Includes 11 8-bit games
- 1.25" LCD screen
- Language: English
- Material: ABS

MINI CONSOLE PORTATILE

- Include 11 giochi in 8-bit
- Schermo LCD da 1,25"
- Lingua: inglese
- Materiale: ABS

MINI CONSOLE PORTABLE

- 11 jeux en 8-bits inclus
- Écran LCD par 1,25 "
- Langue : anglais
- Matériau : ABS

MINICONSOLA PORTÁTIL

- Incluye 11 juegos en 8 bits
- Pantalla LCD de 1,25"
- Idioma: inglés
- Material: ABS

MITNEHMBARE MINI-KONSOLE

- Enthält 11 8-Bit-Spiele
- LCD-Bildschirm einer Größe von 1,25"
- Sprache: Englisch
- Material: ABS

PACKAGING

carded

L 10 x H 15 x W 1.7 cm



DISPLAY

material: cardboard
L 11.5 x H 26 x W 21.5 cm

8 PCS

MVGKIT1



8 051128 754902



Keychain included



2 x LR44 batteries
(included)

ARCADE MINI

L 5.7 x H 9.5 x W 5.7 cm

MINI ARCADE GAME

- Includes 152 8-bit games
- 1.8" TFT screen
- Language: English
- Material: plastic

MINI VIDEOGIOCO ARCADE

- Include 152 giochi in 8-bit
- Schermo TFT da 1,8"
- Lingua: inglese
- Materiale: plastica

MINI BORNE D'ARCADE

- 152 jeux en 8-bits inclus
- Écran TFT par 1,8 "
- Langue : anglais
- Matériau : plastique

MINI VIDEOJUEGO ARCADE

- Incluye 152 juegos en 8 bits
- Pantalla TFT de 1,8"
- Idioma: inglés
- Material: plástico

MINI-ARCADE-SPIEL

- Enthält 152 8-Bit-Spiele
- TFT-Bildschirm einer Größe von 1,8"
- Sprache: Englisch
- Material: Kunststoff



3 x AAA batteries
(not included)

152
CLASSIC
GAMES



PACKAGING

cardboard box w/hook
L 10 x H 18.2 x W 6.5 cm

SOLD X 4

MMAC0001



8 059174 839963



ARCADE ZONE

L 8.5 x H 15.4 x W 9 cm

MINI ARCADE GAME

- Includes 240 8-bit games
- 2.5" TFT screen
- Language: English
- Material: plastic

MINI VIDEOGIOCO ARCADE

- Include 240 giochi in 8-bit
- Schermo TFT da 2,5"
- Lingua: inglese
- Materiale: plastica

MINI BORNE D'ARCADE

- 240 jeux en 8-bits inclus
- Écran TFT par 2,5 "
- Langue : anglais
- Matériau : plastique

MINI VIDEOJUEGO ARCADE

- Incluye 240 juegos en 8 bits
- Pantalla TFT de 2,5"
- Idioma: inglés
- Material: plástico

MINI-ARCADE-SPIEL

- Enthält 240 8-Bit-Spiele
- TFT-Bildschirm einer Größe von 2,5"
- Sprache: Englisch
- Material: Kunststoff

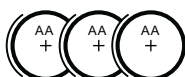

3 x AA batteries
(not included)

240
CLASSIC
GAMES



PACKAGING

window box w/hook
L 10.2 x H 23 x W 10.2 cm

SOLD X 4

MAC0001



8 059174 839970



Wonderland

COLLECTION



SUPER STARS



L MAX 8.5 cm

ADHESIVE GLOW-IN-THE-DARK STARS

• Material: PVC

STELLE FOSFORESCENTI ADESIVE

• Materiale: PVC

ÉTOILES PHOSPHORESCENTES AUTOCOLLANTES

• Matériau : PVC

ESTRELLAS FOSFORESCENTES ADHESIVAS

• Material: PVC

KLEBE-LEUCHTSTERNE

• Material: PVC



PACKAGING

carded
L 18.5 x H 17.8 x W 1 cm



DISPLAY

material: cardboard
L 18 x H 26 x W 19.5 cm
10 PCS

GLWKIT1



25 single-use
double-sided
stickers included

SUPER MOON



Ø 15 cm

ADHESIVE GLOW-IN-THE-DARK MOON

• Material: PVC

LUNA FOSFORESCENTE ADESIVA

• Materiale: PVC

LUNE PHOSPHORESCENTE AUTOCOLLANTE

• Matériau : PVC

LUNA FOSFORESCENTE ADHESIVA

• Material: PVC

KLEBE-LEUCHTMOND

• Material: PVC



PACKAGING

carded
L 19.5 x H 24 x W 2 cm



DISPLAY

material: cardboard
L 18 x H 33 x W 21 cm
8 PCS

GLWKIT2



Base with single-use
adhesive



MY SECRET DIARY

L 11 x H 15.5 x W 2.4 cm

SECRET DIARY WITH PADLOCK
• 100 g/m² paper, 328 pages

DIARIO SEGRETO CON LUCCHETTO
• Carta 100 g/m², 328 pagine

JOURNAL INTIME AVEC CADENAS
• Papier 100 g/m², 328 pages

DIARIO SEGRETO CON CANDADO
• Papel de 100 g/m², 328 páginas

GEHEIMES TAGEBUCH MIT VORHÄNGSCHLOSS
• Papier 100 g/m², 328 Seiten



PACKAGING
PET box
L 15 x H 15.8 x W 2.8 cm
SOLD X 2



FSC®
CERTIFIED PAPER



SPACE
DIA0008



8 051122 269914



PANDA
DIA0009



8 051122 269921



UNICORN
DIA0010



8 051122 269938

LIGHT-UP BOUNCY BALL

Ø 7.5 cm

LIGHT-UP BOUNCY BALL
• Lights up when it bounces
• Material: TPU, liquid, TPR

PALLINA RIMBALZANTE LUMINOSA
• Si illumina quando rimbalza
• Materiale: TPU, liquido, TPR

BALLE REBONDISSANTE LUMINEUSE
• Elle s'illumine lorsqu'elle rebondit
• Matériau : TPU, liquide, TPR

PELOTA LUMINOSA DE REBOTE
• Se ilumina cuando rebota
• Material: TPU, líquido, TPR

LEUCHTENDER FLUMMI
• Leuchtet, wenn er Hüpf
• Material: TPU, Flüssigkeit, TPR

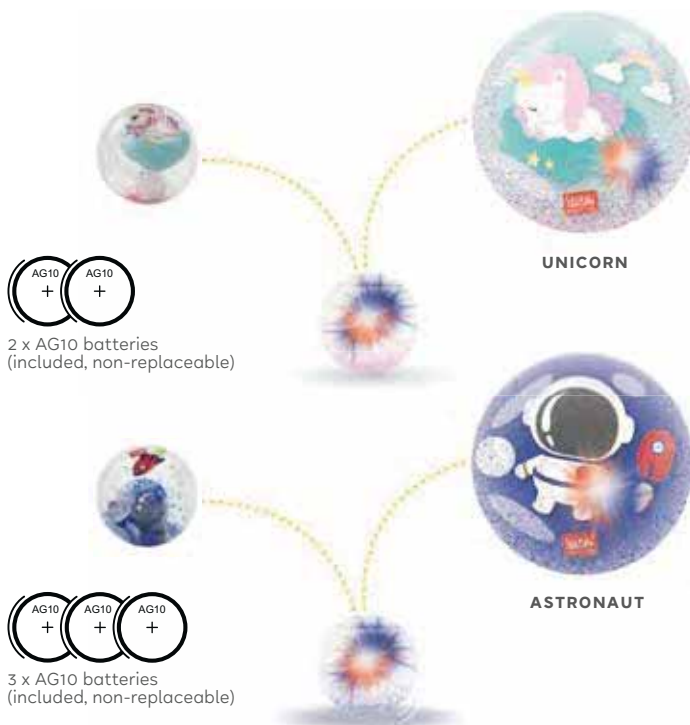

2 x AG10 batteries
(included, non-replaceable)



3 x AG10 batteries
(included, non-replaceable)

DISPLAY
material: cardboard
L 23 x H 17 x W 16 cm
6 PCS

BOBKIT1



8 051128 754513



DISPLAY
material: cardboard
L 23 x H 17 x W 16 cm
6 PCS

BOBKIT2



8 051128 754520



SAVE MONEY

COIN BANK

- With rubber stopper
- Material: ceramic

SALVADANAIO

- Con tappo in gomma
- Materiale: ceramica

TIRELIRE

- Avec bouchon en caoutchouc
- Matériau : céramique

HUCHA

- Con tapón de goma
- Material: cerámica

SPARDOSE

- Mit Gummideckel
- Material: Keramik

SOLD X 2

ROCKET

L 14 x H 21.5 x W 13 cm



PACKAGING

cardboard box
L 16.5 x H 25 x W 16.5 cm

SAVE0006



8 052783 618851

PANDA

L 11.5 x H 12.5 x W 15.5 cm



PACKAGING

cardboard box
L 20 x H 15.5 x W 16.5 cm

SAVE0007



8 052783 618868

PIGGY

L 13 x H 11 x W 11.5 cm



PACKAGING

cardboard box
L 16.5 x H 15.5 x W 13.5 cm

SAVE0008



8 051739 307016

DINO

L 13.5 x H 18 x 10 cm



PACKAGING

cardboard box
L 18.5 x H 21.5 x W 14 cm

SAVE0009



8 052461 966106

UNICORN

L 20.5 x H 18.5 x W 7.5 cm



PACKAGING

cardboard box
L 23 x H 21.5 x W 11 cm

SAVE0010



8 052461 966113



Stationery

COLLECTION



WRITING IS MAGIC



H 20 x L 3.5 cm

PEN WITH UNICORN LIGHT

- Blue ink, 0.7 mm tip
- Knock the unicorn on the table and it lights up

PENNA CON UNICORNO LUMINOSO

- Inchiostro blu, punta 0,7 mm
- Battendo l'unicorno sul tavolo, s'illumina

STYLO AVEC LICORNE LUMINEUSE

- Encre bleue, pointe 0,7 mm
- En battant la licorne sur la table, elle s'illumine

BOLÍGRAFO CON UNICORNIO LUMINOSO

- Tinta azul, punta de 0,7 mm
- Golpea el unicornio en la mesa para iluminarlo

KUGELSCHREIBER MIT LEUCHTENDEM EINHORN

- Blaue Tinte, Spitze 0,7 mm
- Klopfen Sie das Einhorn auf den Tisch und es beginnt zu leuchten



3 x LR621 batteries
(included, non-replaceable)



DISPLAY

material: PET
Ø 11 cm, H 20.5 cm
12 PCS



UPKIT1



8 051128 751949

WRITING IS MAGIC



H 20 x L 3.5 cm

PEN WITH NARWHAL LIGHT

- Blue ink, 0.7 mm tip
- Knock the narwhal on the table and it lights up

PENNA CON NARVALO LUMINOSO

- Inchiostro blu, punta 0,7 mm
- Battendo il narvalo sul tavolo, s'illumina

STYLO AVEC NARVAL LUMINEUX

- Encre bleue, pointe 0,7 mm
- En battant le narval sur la table, il s'illumine

BOLÍGRAFO CON NARVAL LUMINOSO

- Tinta azul, punta de 0,7 mm
- Golpea el narval en la mesa para iluminarlo

KUGELSCHREIBER MIT LEUCHTENDEM NARVAL

- Blaue Tinte, Spitze 0,7 mm
- Klopfen Sie den Narwal auf den Tisch und es beginnt zu leuchten

* While stock lasts

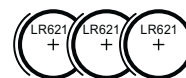

3 x LR621 batteries
(included, non-replaceable)



DISPLAY

material: PET
Ø 11 cm, H 20.5 cm
12 PCS



NPKIT1 *



8 051128 752649

POMPOM PEN



Ø 5.5 cm, H 17 cm

BALLPOINT PEN WITH POMPOM

- Black ink, 1.0 mm tip

PENNA A SFERA CON POM-POM

- Inchiostro nero, punta 1,0 mm

STYLO À BILLE AVEC POMPON

- Encre noire, pointe 1,0 mm

BOLÍGRAFO CON POMPÓN

- Tinta negra, punta de 1,0 mm

KUGELSCHREIBER MIT BOMMEL

- Schwarze Tinte, Spitze 1,0 mm

INDIVIDUAL DESIGNS: SOLD X 4

FIRST ORDER: MOQ 1 FULL
ASSORTED DISPLAY (12 PCS)

material: cardboard
L 20 x H 17.5 x W 14.5 cm
12 PCS: 4 X COLOUR

POMKIT2



8 051128 752984



POM0002



8 051122 265831



POM0003



8 051122 265848



POM0004



8 051122 265855

ERASABLE PEN

Ø 0.8 cm, H 15 cm

ERASABLE GEL PEN

- Thermo-sensitive ink

PENNA GEL CANCELLABILE

- Inchiostro termosensibile

STYLO À ENCRE GEL EFFAÇABLE

- Encre thermosensible

BOLÍGRAFO DE GEL BORRABLE

- Tinta termosensibile

LÖSCHBARER GELSTIFT

- Thermoempfindliche Tinte



DISPLAY
material: cardboard
L 5 x H 14 x W 15.5 cm
30 PCS

EPBLAKIT1



DISPLAY
material: cardboard
L 5 x H 14 x W 15.5 cm
30 PCS

EPBLAKIT4



DISPLAY
material: cardboard
L 5 x H 14 x W 15.5 cm
30 PCS

EPBLAKIT5



DISPLAY
material: cardboard
L 5 x H 14 x W 15.5 cm
30 PCS

EPBLAKIT9



DISPLAY
material: cardboard
L 5 x H 14 x W 15.5 cm
30 PCS

EPBLUKIT1



8 051128 752908



8 051128 753004



8 051128 753011



8 051128 755206



8 051128 752915

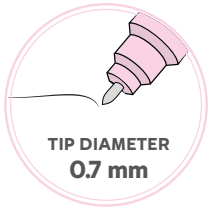

BLUE INK



BLUE INK



RED INK



GREEN INK



PINK INK



DISPLAY
material: cardboard
L 5 x H 14 x W 15.5 cm
30 PCS

EPBLUKIT6



DISPLAY
material: cardboard
L 5 x H 14 x W 15.5 cm
30 PCS

EPBLUKIT0



DISPLAY
material: cardboard
L 5 x H 14 x W 15.5 cm
30 PCS

EPREDKIT1



DISPLAY
material: cardboard
L 5 x H 14 x W 15.5 cm
30 PCS

EPGREKIT7



DISPLAY
material: cardboard
L 5 x H 14 x W 15.5 cm
30 PCS

EPPINKIT8



REFILL FOR ERASABLE PEN



Ø 4 mm, H 13 cm

REFILL FOR ERASABLE GEL PEN - PACK 3 PCS

- Thermo-sensitive ink

REFILL PER PENNA GEL CANCELLABILE - SET 3 PEZZI

- Inchiostro termosensibile

RECHARGES POUR STYLO À ENCRE GEL EFFAÇABLE - SET DE 3 PIÈCES

- Encre thermosensible

RECARGAS PARA BOLÍGRAFO DE GEL BORRABLE - SET DE 3 UNIDADES

- Tinta termosensible

NACHFÜLLPACKUNG FÜR LÖSCHBAREN GELSTIFT - 3ER SET

- Thermoempfindlichen Tinte

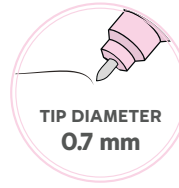

BLACK INK



BLUE INK



RED INK



GREEN INK



PINK INK

PACKAGING
carded
L 6 x H 18 x W 0.5 cm
SOLD X 10

PACKAGING
carded
L 6 x H 18 x W 0.5 cm
SOLD X 10

PACKAGING
carded
L 6 x H 18 x W 0.5 cm
SOLD X 10

PACKAGING
carded
L 6 x H 18 x W 0.5 cm
SOLD X 10

PACKAGING
carded
L 6 x H 18 x W 0.5 cm
SOLD X 10



DISPLAYS ON DEMAND

Products not included

SMALL EMPTY COUNTER DISPLAY

- 2 hooks
- material: cardboard
- L 13 x H 27 x W 10 cm
- minimum order qty: 50 pcs



MEDIUM EMPTY COUNTER DISPLAY

- 12 pockets
- material: acrylic
- L 23.5 x H 26 x W 17 cm
- minimum order qty: 300 pcs



CLICK&CLACK

Ø 1.2 cm, H 14 cm

TWO-COLOUR BALLPOINT PEN

• Tip diameter 1.0 mm

PENNA A SFERA A DUE COLORI

• Diametro della punta 1,0 mm

STYLO À BILLE 2 COULEURS

• Diamètre de la pointe 1,0 mm

BOLÍGRAFO DE 2 COLORES

• Diámetro de la punta 1,0 mm

ZWEIFARBIGER KUGELSCHREIBER

• Durchmesser der Spitze 1,0 mm

**MISS FLAMINGO**

BLACK INK

PINK INK

DISPLAYmaterial: cardboard
L 7 x H 21.5 x W 13.5 cm**12 PCS****CLICKKIT16**

8 051128 755114

**HUG ME**

BLUE INK

GREEN INK

DISPLAYmaterial: cardboard
L 7 x H 21.5 x W 13.5 cm**12 PCS****CLICKKIT19**

8 051128 755121

**DREAM BIG**

AQUA INK

PINK INK

DISPLAYmaterial: cardboard
L 7 x H 21.5 x W 13.5 cm**12 PCS****CLICKKIT20**

8 051128 755138

**ALICE**

PURPLE INK

BLACK INK

DISPLAYmaterial: cardboard
L 7 x H 21.5 x W 13.5 cm**12 PCS****CLICKKIT21**

8 051128 755145

**LLAMA**

AQUA INK

PINK INK

DISPLAYmaterial: cardboard
L 7 x H 21.5 x W 13.5 cm**12 PCS****CLICKKIT22**

8 051128 755152

**SPACE**

RED INK

BLUE INK

DISPLAYmaterial: cardboard
L 7 x H 21.5 x W 13.5 cm**12 PCS****CLICKKIT23**

8 051128 755169

**PANDA**

PINK INK

BLACK INK

DISPLAYmaterial: cardboard
L 7 x H 21.5 x W 13.5 cm**12 PCS****CLICKKIT24**

8 051128 755176

**FOR DREAMERS ONLY**

Ø 1 cm, H 14 cm

SET OF 3 BALLPOINT PENS

• Black ink, 1.0 mm tip

SET DI 3 PENNE A SFERA

• Inchiostro nero, punta 1,0 mm

SET DE 3 STYLOS À BILLE

• Encre noire, pointe 1,0 mm

SET DE 3 BOLÍGRAFOS

• Tinta negra, punta de 1,0 mm

SET AUS 3 KUGELSCHREIBERN

• Schwarze Tinte, Spitze 1,0 mm

* While stock lasts

BLACK INK

**PACKAGING**window box
L 8.5 x H 19.5 x
W 1.5 cm
DISPLAY
material: cardboard
L 10 x H 30.8 x W 21 cm
12 PCS
PENKIT1 *

8 051128 752274

**BOOKLOVER**

Ø 1 cm, H 14 cm

SET OF 2 BALLPOINT PENS

• Black ink, 1.0 mm tip

SET DI 2 PENNE A SFERA

• Inchiostro nero, punta 1,0 mm

SET DE 2 STYLOS À BILLE

• Encre noire, pointe 1,0 mm

SET DE 2 BOLÍGRAFOS

• Tinta negra, punta de 1,0 mm

SET AUS 2 KUGELSCHREIBERN

• Schwarze Tinte, Spitze 1,0 mm

* While stock lasts

BLACK INK

**PACKAGING**window box
L 8.5 x H 19.5 x
W 1.5 cm
DISPLAY
material: cardboard
L 10 x H 30.8 x W 21 cm
12 PCS
PENKIT2 *

8 051128 752281



CACTUS PEN

BLACK INK

L 3 x H 15,2 cm, Ø 1.4 cm

GEL PEN

- Black ink
- Tip diameter 0.5 mm

PENNA GEL

- Inchiostro nero
- Diametro della punta 0,5 mm

STYLO À ENCRE GEL

- Encre noire
- Diamètre de la pointe 0,5 mm

BOLÍGRAFO DE GEL

- Tinta negra
- Diámetro de la punta 0,5 mm

GELSTIFT

- Schwarze Tinte
- Durchmesser der Spitze 0,5 mm



DISPLAY
material: PET and cardboard
L 11,8 x H 16,5 x W 10,7 cm
16 PCS

CTSKIT2



WATERMELON PEN

BLACK INK

L 2 x H 14,8 x W 1 cm

GEL PEN

- Black ink
- Tip diameter 0.5 mm

PENNA GEL

- Inchiostro nero
- Diametro della punta 0,5 mm

STYLO À ENCRE GEL

- Encre noire
- Diamètre de la pointe 0,5 mm

BOLÍGRAFO DE GEL

- Tinta negra
- Diámetro de la punta 0,5 mm

GELSTIFT

- Schwarze Tinte
- Durchmesser der Spitze 0,5 mm



DISPLAY
material: cardboard
L 19 x H 20 x W 9 cm
24 PCS

MELKIT1



CROCODILE PEN

BLACK INK

L 14,5 x H 1,5 x W 1,9 cm

GEL PEN

- Black ink
- Tip diameter 0.5 mm

PENNA GEL

- Inchiostro nero
- Diametro della punta 0,5 mm

STYLO À ENCRE GEL

- Encre noire
- Diamètre de la pointe 0,5 mm

BOLÍGRAFO DE GEL

- Tinta negra
- Diámetro de la punta 0,5 mm

GELSTIFT

- Schwarze Tinte
- Durchmesser der Spitze 0,5 mm



DISPLAY
material: PET and cardboard
L 10,8 x H 14 x W 10,5 cm
16 PCS

CROCKIT1



HELLO SUMMER

BLACK INK

L 1,5 x H 16 x W 1 cm

GEL PEN

- Black ink
- Tip diameter 0.5 mm

PENNA GEL

- Inchiostro nero
- Diametro della punta 0,5 mm

STYLO À ENCRE GEL

- Encre noire
- Diamètre de la pointe 0,5 mm

BOLÍGRAFO DE GEL

- Tinta negra
- Diámetro de la punta 0,5 mm

GELSTIFT

- Schwarze Tinte
- Durchmesser der Spitze 0,5 mm



DISPLAY
material: PET and cardboard
L 10,8 x H 14 x W 10,5 cm
16 PCS

ICEKIT1



DISPLAY
material: PET and cardboard
L 10,8 x H 14 x W 10,5 cm
16 PCS

ICEKIT2



MAGIC RAINBOW

Ø 1.4 cm, H 11 cm

6-COLOUR BALLPOINT PEN

- Ink colours: black, red, purple, orange, green and blue
- Tip diameter 1.0 mm

PENNA A SFERA 6 COLORI

- Colori inchiostri: nero, rosso, viola, arancione, verde e blu
- Diametro della punta 1,0 mm

STYLO À BILLE 6 COULEURS

- Couleurs encre : noir, rouge, violet, orange, vert et bleu
- Diamètre de la pointe 1,0 mm

BOLÍGRAFO DE 6 COLORES

- Colores de la tinta: negro, rojo, violeta, naranja, verde y azul
- Diámetro de la punta 1,0 mm

KUGELSCHREIBER IN 6 FARBEN

- Tintenfarben: Schwarz, Rot, Violett, Orange, Grün und Blau
- Durchmesser der Spitze 1,0 mm

**DISPLAY**

material: cardboard
L 18,5 x H 19,5 x W 15 cm

48 PCS**SIXKIT1**

8 051128 751031

**SHINE LIKE A DIAMOND**

Ø 0.8 cm, H 10.8 cm

SET OF 6 GLITTER MINI GEL PENS

- Tip diameter 1.0 mm

SET DI 6 MINI PENNE GEL GLITTERATE

- Diametro della punta 1,0 mm

SET DE 6 MINI STYLOS À ENCRE GEL PAILLETÉS

- Diamètre de la pointe 1,0 mm

SET DE 6 MINIBOLÍGRAFOS DE GEL CON PURPURINA

- Diámetro de la punta 1,0 mm

SET AUS 6 GLITZERENDE MINI-GELSTIFTEN

- Durchmesser der Spitze 1,0 mm

**DISPLAY**

material: cardboard
L 15 x H 22 x W 13 cm

12 PCS**GGPKIT1**

8 051128 753042

**PACKAGING**

PET box w/ hook
L 7.5 x H 13.2 x W 2 cm

**TWIST**

Ø 1 cm, H 14.5 cm

SET OF 3 MULTICOLOURED GEL PENS

- Tip diameter 1.0 mm

SET DI 3 PENNE GEL MULTICOLORE

- Diametro della punta 1,0 mm

SET DE 3 STYLOS À ENCRE GEL MULTICOLORE

- Diamètre de la pointe 1,0 mm

SET DE 3 BOLÍGRAFOS DE GEL MULTICOLOR

- Diámetro de la punta 1,0 mm

SET AUS 3 GELSTIFTEN MIT BUNTER, FARBWECHSELNDER MINE

- Durchmesser der Spitze 1,0 mm

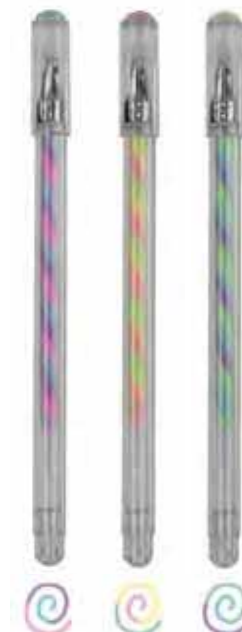
**DISPLAY**

material: cardboard
L 7 x H 22 x W 9 cm

12 PCS**TWPKIT1**

8 051128 753059

**PACKAGING**

PET box w/ hook
L 3.5 x H 17 x W 1.5 cm



PENCILS

I USED TO BE A NEWSPAPER

Ø 0.7 cm, H 18.5 cm

RECYCLED PAPER PENCIL

- HB lead

MATITA IN CARTA RICICLATA

- Mina HB

CRAYON EN PAPIER RECYCLÉ

- Mine HB

LÁPIZ DE PAPEL RECICLADO

- Mina HB

BLEISTIFT AUS RECYCLINGPAPIER

- HB-Mine

DISPLAY

material: PET
Ø 7 cm, H 18.5 cm

48 PCS: 4 X DESIGN

SCVKIT3



COLORFUL POTION

Ø 0.7 cm, H 9 cm

JAR OF 12 COLOUR PENCIL CRAYONS

- Material: wood

12 PASTELLI COLORATI IN BARATTOLO

- Materiale: legno

12 CRAYONS DE COULEUR EN POT

- Matériau : bois

12 LÁPICES DE COLORES EN BOTE

- Material: madera

12 BUNTSTIFTE IM BEHÄLTER

- Material: Holz

PACKAGING

glass jar w/cork lid
Ø 3.7 cm, H 10.5 cm

DISPLAY

material: cardboard
L 22 x H 19 x W 17 cm

12 PCS

PIJKIT1



KOALITY HUGS

Ø 0.7 cm, H 18 cm

PENCIL WITH ERASER

- HB lead

MATITA CON GOMMA

- Mina HB

CRAYON AVEC GOMME

- Mine HB

LÁPIZ CON GOMA

- Mina HB

BLEISTIFT MIT RADIERGUMMI

- HB-Mine

**DISPLAY**material: cardboard
L 15 x H 18 x W 14 cm**24 PCS****KOAKITI**

8 051128 754452

**SERIAL CHILLER**

Ø 0.7 cm, H 18 cm

PENCIL WITH ERASER

- HB lead

MATITA CON GOMMA

- Mina HB

CRAYON AVEC GOMME

- Mine HB

LÁPIZ CON GOMA

- Mina HB

BLEISTIFT MIT RADIERGUMMI

- HB-Mine

**DISPLAY**material: cardboard
L 15 x H 18 x W 14 cm**24 PCS****SLOKITI**

8 051128 752137

**I LOVE BAMBOO**

Ø 0.7 cm, H 18 cm

PENCIL WITH ERASER

- HB lead

MATITA CON GOMMA

- Mina HB

CRAYON AVEC GOMME

- Mine HB

LÁPIZ CON GOMA

- Mina HB

BLEISTIFT MIT RADIERGUMMI

- HB-Mine

**DISPLAY**material: cardboard
L 15 x H 18 x W 14 cm**24 PCS****PANKITI**

8 051128 752700



AFTER RAIN COMES THE RAINBOW

NEW

Ø 0.7 cm, H 19 cm

PENCIL WITH ERASER

- HB lead

MATITA CON GOMMA

- Mina HB

CRAYON AVEC GOMME

- Mine HB

LÁPIZ CON GOMA

- Mina HB

BLEISTIFT MIT RADIERGUMMI

- HB-Mine



DISPLAY

material: cardboard
L 15 x H 19 x W 14 cm

24 PCS

RAINKIT1



8 051128 755381



UNICORN PENCIL

Ø 0.7 cm, H 19 cm

PENCIL WITH ERASER

- HB lead

MATITA CON GOMMA

- Mina HB

CRAYON AVEC GOMME

- Mine HB

LÁPIZ CON GOMA

- Mina HB

BLEISTIFT MIT RADIERGUMMI

- HB-Mine



DISPLAY

material: cardboard
L 14 x H 19 x W 15 cm

24 PCS

UNIKIT1



8 051128 751338



NO DRAMA LLAMA

Ø 0.7 cm, H 19 cm

PENCIL WITH ERASER

- HB lead

MATITA CON GOMMA

- Mina HB

CRAYON AVEC GOMME

- Mine HB

LÁPIZ CON GOMA

- Mina HB

BLEISTIFT MIT RADIERGUMMI

- HB-Mine

* While stock lasts

INDIVIDUAL DESIGNS: SOLD X 12



LAMA0001



8 052783 613412



LAMA0002 *



8 052783 613566

FIRST ORDER: MOQ 1 FULL ASSORTED DISPLAY (24 PCS)

material: cardboard
L 14 x H 19 x W 15 cm

24 PCS: 12 X DESIGN

LAMAKIT1 *



8 051128 752120



FLUFFY PENCIL

Ø 0.7 cm, H 19 cm

PENCIL WITH FEATHERS

- HB lead

MATITA CON PIUME

- Mina HB

CRAYON AVEC PLUMES

- Mine HB

LÁPIZ CON PLUMAS

- Mina HB

BLEISTIFT MIT FEDERN

- HB-Mine

**DISPLAY**

material: cardboard
L 20 x H 21 x W 15 cm
24 PCS: 4 X COLOUR

FLF0007



8 051128 750409

**LITTLE SWEET FRIENDS**

Ø 0.7 cm, H 17.7 cm

SET OF 3 PENCILS

- HB lead

SET DI 3 MATITE

- Mina HB

SET DE 3 CRAYONS

- Mine HB

SET DE 3 LÁPICES

- Mina HB

SET AUS 3 BLEISTIFTEN

- HB-Mine

**PACKAGING**

carded
L 10 x H 23 cm

**DISPLAY**

material: cardboard
L 13 x H 31.5 x W 16.5 cm
14 PCS

APKIT2



8 051128 751314

**TO THE MOON AND BACK**

Ø 0.7 cm, H 17.5 cm

STATIONERY SET

- Set of two erasers and an HB-lead pencil

SET DA SCRIVANIA

- Set di due gomme e una matita con mina HB

SET PAPETERIE

- Set comprenant deux gommes et un crayon avec mine HB

SET DE ESCRITORIO

- Set de dos gomas y un lápiz con mina HB

SCHREIBTISCHSET

- Set aus zwei Radiergummis und einem Bleistift mit HB-Mine

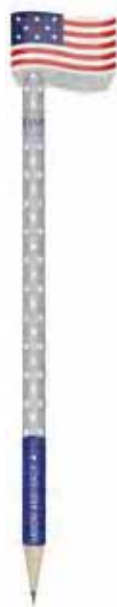
**PACKAGING**

carded
L 10 x H 22.7 cm

**DISPLAY**

material: cardboard
L 11.5 x H 33.5 x W 22 cm
10 PCS

ASTROKIT1



8 051128 751635



ERASERS

YUMMY YUMMY

L 2.7 x H 6 x W 2.8 cm

SET OF 3 SCENTED ERASERS

SET DI 3 GOMME PROFUMATE

SET DE 3 GOMMES PARFUMÉES

SET DE 3 GOMAS PERFUMADAS

SET AUS 3 RADIERGUMMIS MIT DUFT

PACKAGING

PET box w/fabric loop
L 8.5 x H 6 x W 3 cm

SOLD X 12

ERA0001



8 052461 964324



Grapes



Strawberry



Vanilla



SOLAR SYSTEM

Ø MIN 0.8 cm - Ø MAX 3.5 cm

SET OF 9 ERASERS

SET DI 9 GOMME

SET DE 9 GOMMES

SET DE 9 GOMAS

SET AUS 9 BUNTEN RADIERGUMMIS

PACKAGING

carded
Ø 16.5 cm, W 2.5 cm

SOLD X 6

SES0001



8 059174 834739

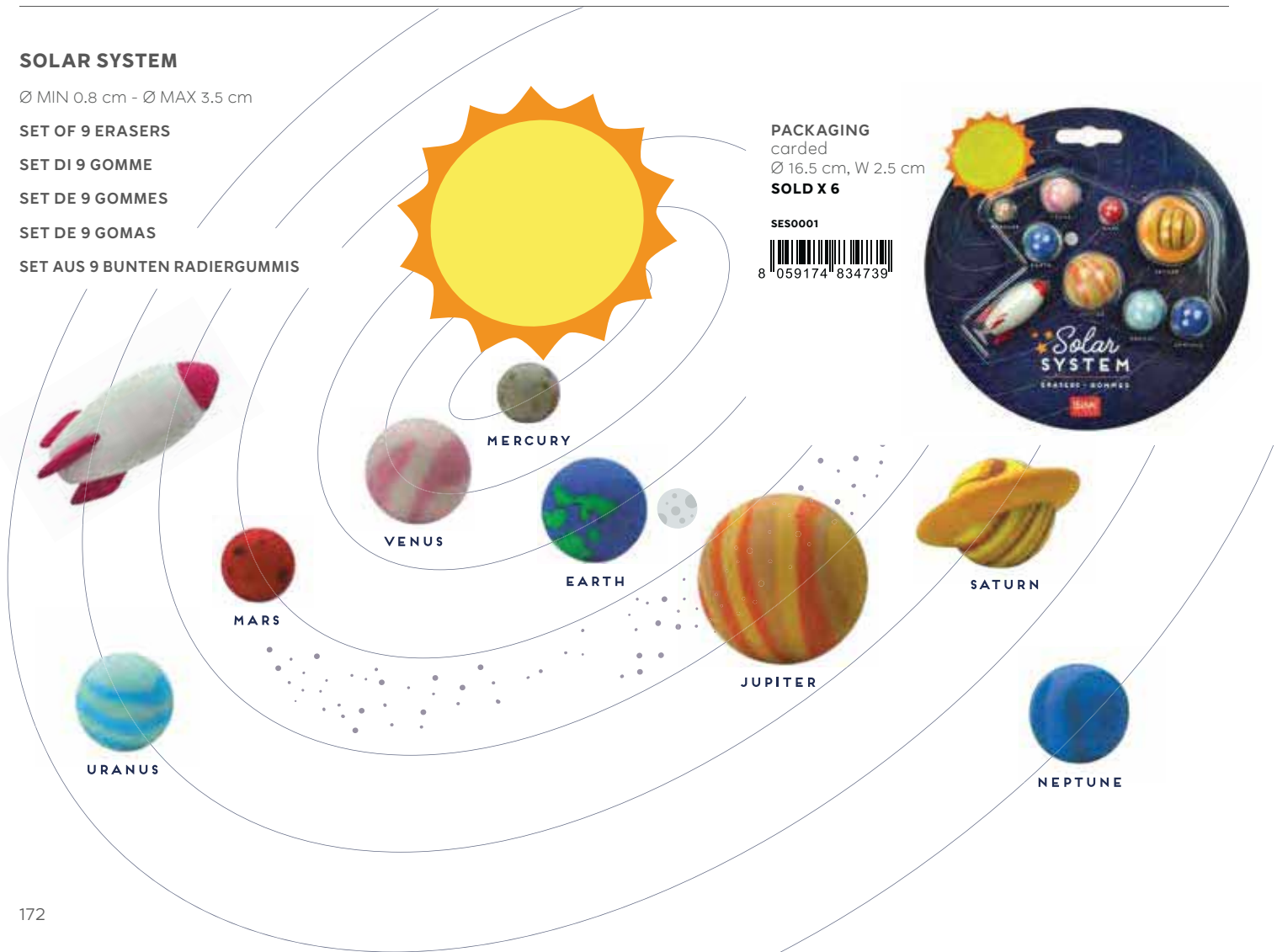

FREE HUGS

L 3 x H 5 cm

SET OF 5 ERASERS

SET DI 5 GOMME

SET DE 5 GOMMES

SET DE 5 GOMAS

SET AUS 5 RADIERGUMMIS

PACKAGING

PET box
L 15.7 x H 7 x W 2.5 cm

SOLD X 6

CE0001



8 058093 948770



XOXO

Ø 2 cm, H 7.2 cm

SCENTED ERASER

GOMMA PROFUMATA

GOMME PARFUMÉE

GOMA PERFUMADA

RADIERGUMMI MIT DUFT

PANDA



DISPLAY

material: cardboard
L 8 x H 16 x W 17.5 cm

36 PCS

LIPKITPAN



8 051128 752335

UNICORN



DISPLAY

material: cardboard
L 8 x H 16 x W 17.5 cm

36 PCS

LIPKITUNI



8 051128 752328

LOVE POTION

L 1.4 x H 1.2 cm

SET OF 18 ERASERS

SET DI 18 GOMME

SET DE 18 GOMMES

SET DE 18 GOMAS

SET AUS 18 RADIERGUMMIS

DISPLAY

material: cardboard
L 18 x H 14.5 x W 13 cm

12 PCS

LPKIT1



8 051128 751260



PACKAGING

plastic jar w/cork lid
Ø 4 cm, H 7.3 cm



BRICK BY BRICK

L 2.5 (small) - L 5 (large) x H 2.5 x W 1.2 cm

SET OF 6 ERASERS

SET DI 6 GOMME

SET DE 6 GOMMES

SET DE 6 GOMAS

SET AUS 6 RADIERGUMMIS

DISPLAY

material: cardboard
L 9.5 x H 27.5 x W 18 cm

12 PCS

BRIKIT1



8 051128 751352



PACKAGING

carded
L 8.2 x H 18.5 cm



LET'S AVOCUDDLE



L 5 x H 3.7 x W 2 cm

MAXI ERASER

MAXI GOMMA

MAXI GOMME

MAXI GOMA

MAXI-RADIERGUMMI

DISPLAY

material: PET

Ø 12 cm, H 14.5 cm

32 PCS

AVOKIT1



8 051128 755411



THE KING OF THE BUTTONS

Ø 6 cm

MAXI ERASER

MAXI GOMMA

MAXI GOMME

MAXI GOMA

MAXI-RADIERGUMMI

DISPLAY

material: PET

Ø 12 cm, H 14.5 cm

21 PCS: 7 X COLOUR

BUTT001



8 055748 243716



FOOTBALL ERASER

Ø 3.5 cm

MAXI ERASER

MAXI GOMMA

MAXI GOMME

MAXI GOMA

MAXI-RADIERGUMMI

DISPLAY

material: PET

Ø 12 cm, H 14.5 cm

32 PCS

FTBKIT1



8 051128 750058



DICE ERASER

L 2.5 x H 2.5 x W 2.5 cm

SET OF 2 ERASERS

SET DI 2 GOMME

SET DE 2 GOMMES

SET DE 2 GOMAS

SET AUS 2 RADIERGUMMIS

DISPLAY

material: PET

Ø 12 cm, H 14.5 cm

26 PCS

DICKIT1



8 051128 751482



PEANUT ERASER

L 6.5 x H 2.5 cm

MAXI ERASER

MAXI GOMMA

MAXI GOMME

MAXI GOMA

MAXI-RADIERGUMMI

DISPLAY

material: PET

Ø 12 cm, H 14.5 cm

36 PCS

PEAKIT4



8 051128 751451



WALNUT ERASER

L 4.5 x H 3 cm

MAXI ERASER

MAXI GOMMA

MAXI GOMME

MAXI GOMA

MAXI-RADIERGUMMI

DISPLAY

material: PET

Ø 12 cm, H 14.5 cm

24 PCS

WALKIT4



8 051128 751444



PENCIL SHARPENERS

ROARR

L 4.5 x H 5 x W 3 cm

PENCIL SHARPENER

TEMPERINO

TAILLE-CRAYON

SACAPUNTAS

ANSPITZER



DISPLAY
material: cardboard
L 20 x H 13 x W 15 cm
12 PCS

DINKIT1



8 051128 754339



LE TOUR DU MONDE

Ø 4.5 cm, H 5.5 cm

PENCIL SHARPENER

TEMPERINO

TAILLE-CRAYON

SACAPUNTAS

ANSPITZER



PACKAGING
cardboard box
L 4.5 x H 5.5 x W 4.5 cm

DISPLAY
material: cardboard
L 14.5 x H 18 x W 19 cm
12 PCS

TOURKIT1



8 051128 750577



LET'S ROCK

Ø 3.8 cm, H 7.2 cm

ERASER WITH SHARPENER

GOMMA CON TEMPERINO

GOMME AVEC TAILLE-CRAYON

GOMA CON SACAPUNTAS

RADIERGUMMI MIT ANSPITZER



PACKAGING
PET box
L 4.5 x H 7.5 x W 4.5 cm

DISPLAY
material: cardboard
L 19 x H 17.5 x W 12.5 cm
12 PCS

MICKIT2



8 051128 753103



TWO IN ONE

Ø 3.5 cm, H 6.2 cm

ERASER WITH DOUBLE SHARPENER

GOMMA CON TEMPERINO DOPPIO

GOMME AVEC DOUBLE TAILLE-CRAYON

GOMA CON SACAPUNTAS DOBLE

RADIERGUMMI MIT DOPPELANSPITZER



DISPLAY
material: cardboard
L 16.5 x H 15 x W 12.5 cm
12 PCS: 6 X COLOUR

TIOKIT1



8 051128 750775



MAGIC MUSHROOM

Ø 4.5 cm, H 5 cm

ERASER WITH SHARPENER

GOMMA CON TEMPERINO

GOMME AVEC TAILLE-CRAYON

GOMA CON SACAPUNTAS

RADIERGUMMI MIT ANSPITZER



PACKAGING
cardboard box
L 5 x H 5.5 x W 5 cm

DISPLAY
material: cardboard
L 15.5 x H 17 x W 20.5 cm
12 PCS

MUSKIT2



8 051128 752427



FLOWER POWER

Ø 4.5 cm, H 5 cm

ERASER WITH SHARPENER

GOMMA CON TEMPERINO

GOMME AVEC TAILLE-CRAYON

GOMA CON SACAPUNTAS

RADIERGUMMI MIT ANSPITZER



PACKAGING
cardboard box
L 4.7 x H 5.3 x W 4.7 cm

DISPLAY
material: cardboard
L 15 x H 17 x W 20 cm
12 PCS: 3 X COLOUR

FLOKIT2



8 051128 752014



TO THE MOON AND BACK

L 8 x H 9.5 x W 8.5 cm

DESKTOP PENCIL SHARPENER

- Adjustable sharpening, removable tray

TEMPERAMATITE A MANOVELLA

- Affilatura regolabile, vassoio estraibile

TAILLE-CRAYON À MANIVELLE

- Aiguisage réglable, plateau amovible

SACAPUNTAS DE MANIVELA

- Afilado ajustable, bandeja para virutas extraíble

ANSPITZER MIT HANDKURBEL

- Einstellbares Anspitzen, abnehmbares Behältnis



PACKAGING

cardboard box
L 8.5 x H 9.5 x W 8 cm

SOLD X 4

PSA0001

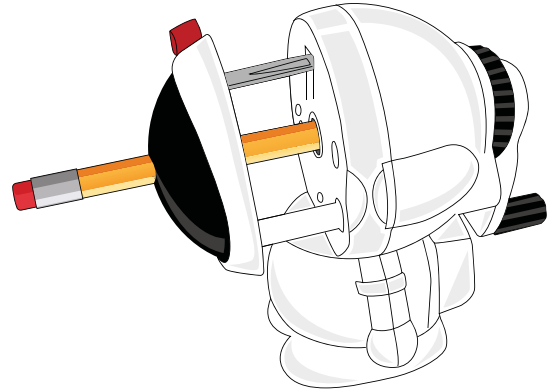

CAMERA PENCIL SHARPENER

L 7 x H 10 x W 11.5 cm

DESKTOP PENCIL SHARPENER

- Adjustable sharpening, removable tray

TEMPERAMATITE A MANOVELLA

- Affilatura regolabile, vassoio estraibile

TAILLE-CRAYON À MANIVELLE

- Aiguisage réglable, plateau amovible

SACAPUNTAS DE MANIVELA

- Afilado ajustable, bandeja para virutas extraíble

ANSPITZER MIT HANDKURBEL

- Einstellbares Anspitzen, abnehmbares Behältnis



PACKAGING

cardboard box
L 11.8 x H 11 x W 7.2 cm

SOLD X 4

CPS0001

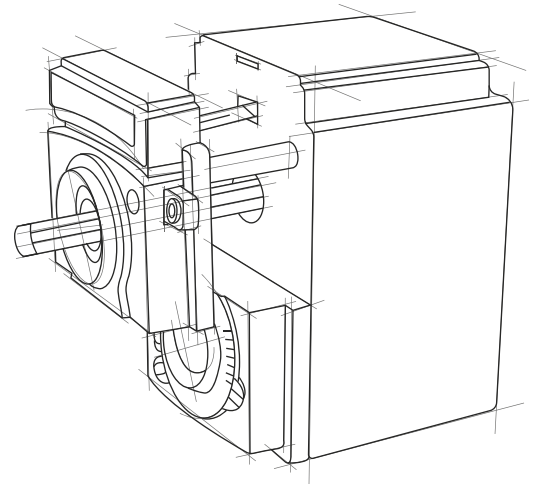

PENCIL CASES

PENCIL CASE

L 19.5 x H 5.5 x W 5.5 cm

TRANSPARENT PENCIL CASE
• Material: transparent TPU

ASTUCCIO TRASPARENTE
• Materiale: TPU trasparente

TROUSSE TRANSPARENTE
• Matériau : TPU transparente

ESTUCHE TRANSPARENTE
• Material: TPU transparente

**TRANSPARENTES
FEDERMÄPPCHEN**
• Material: transparentes TPU

PACKAGING
PET box w/hook
L 23.5 x H 6.5 x W 6.5 cm
SOLD X 3



CHOOSE HAPPINESS
PC0017



8 052461 962337



GENIUS
PC0018



8 052461 962344



STARS
PC0019



8 052461 962351



CHERRY BOMB
PC0020



8 052461 962368



FLORA
PC0021



8 052461 962375



PANDA
PC0023



8 052461 962399

CUTE!

L 20 x H 5 x W 3 cm

SOFT SILICONE PENCIL CASE
• Capacity: about 10 pens
• Dual use: opens up completely or opens up partially thanks to the silicone zip stopper flaps

ASTUCCIO IN MORBIDO SILICONE
• Capacità: circa 10 penne
• Doppio utilizzo: si apre completamente oppure si apre parzialmente grazie alle alette ferma cerniera in silicone

TROUSSE EN SILICONE SOUPLE
• Capacité : environ 10 stylos
• Double utilisation : elle peut s'ouvrir complètement ou partiellement, grâce aux ailettes en silicone de blocage de la fermeture éclair

ESTUCHE DE SILICONA BLANDA
• Capacidad: 10 bolígrafos aproximadamente
• Doble uso: se abre completamente o se abre parcialmente gracias a las aletas de bloqueo en silicona de la cremallera

FEDERMÄPPCHEN AUS WEICHEM SILIKON
• Bietet Platz für: ca. 10 Stifte
• Doppelte Verwendung: Vollständige Öffnung oder teilweise Öffnung dank der Silikonflügel, die als Reißverschluss-Stopper dienen

PACKAGING
PET box w/hook
L 24.5 x H 5 x W 3 cm
SOLD X 3



Pens not included



Opens up partially thanks to the silicone zip stopper flaps



Opens up completely



PCS0001 PINK



8 051739 306965



PCS0002 AQUA



8 051739 306972



PCS0003 LILAC



8 051739 306989

*ONE MORE DESIGN ON PAGE 202

DESK ACCESSORIES

MINI STATIONERY SET

MINI STATIONERY SET

- The set includes 6 mini accessories: scissors, highlighter, page markers, adhesive tape with dispenser, stapler and staples

MINI SET DI CANCELLERIA

- Il set include 6 accessori in formato mini: forbici, evidenziatore, segnapagina, nastro adesivo con dispenser, cucitrice e punti metallici

MINI SET DE PAPETERIE

- Le set contient 6 accessoires de bureau en format mini : ciseaux, surligneur, marque-pages, ruban adhésif avec dérouleur, agrafeuse et agrafes

MINI SET DE PAPELERÍA

- El set incluye 6 accesorios en formato mini: tijeras, subrayador, marcapáginas, cinta adhesiva con dispensador, grapadora y grapas

MINI-SCHREIBWARENSET

- Das Set umfasst 6 Accessoires im Miniformat: Schere, Textmarker, Seitenmarkierer, Klebeband mit Abrollgerät, Heftzange und Heftklammern

PACKAGING

PP box
L 6.5 x H 10.5 x W 3 cm



DISPLAY

material: cardboard
L 11 x H 20 x W 18.5 cm

6 PCS

SETKIT1



PACKAGING

PP box w/ hook
L 9 x H 8 x W 2.6 cm



DISPLAY

material: cardboard
L 11 x H 20 x W 18.5 cm

6 PCS

SETKIT2



MINI FRIENDS

L 3 x H 3.5 x W 6.3 cm

MINI STAPLER

- Staple remover incorporated on the back
- 1000 staples included

MINI CUCITRICE

- Levapunti incorporato sul retro
- 1000 punti inclusi

MINI AGRAFEUSE

- Ôte-agrafe intégré à l'arrière
- 1000 agrafes incluses

MINI GRAPADORA

- Quitagrapas incorporado en la parte trasera
- Incluye 1000 grapas

MINI-HEFTZANGE

- Auf der Rückseite integrierter Enthefter
- Inklusive 1000 Heftklammern

PACKAGING

carded
L 9.5 x H 13.5 x W 3 cm



PANDA



DISPLAY

material: cardboard
L 21.5 x H 23 x W 16 cm

8 PCS

STAPKIT1



CARRATE CUTTER

L 3.3 x H 8.2 x W 1.8 cm

MINI RETRACTABLE CUTTER

- Suitable for cutting any paper surface precisely
- Material: ABS, steel

MINI TAGLIERINO A SCOMPARSA

- Adatto per tagliare con precisione qualsiasi superficie cartacea
- Materiale: ABS, acciaio

MINI CUTTER ESCAMOTABLE

- Adapté pour couper avec précision n'importe quelle surface en papier
- Matériau : ABS, acier

MINICÚTER

- Apto para cortar con precisión cualquier superficie de papel
- Material: ABS, acero

EINKLAPPBARER MINI-CUTTER

- Geeignet, um jede Oberfläche aus Papier präzise zu schneiden
- Material: ABS, Stahl

PACKAGING
carded
L 8 x H 14.5 x W 2 cm

**DISPLAY**

material: cardboard
L 17.5 x H 22.5 x W 15.5 cm
12 PCS

RCUTKIT1**HAPPY RULER**

L 13.5 x H 3.5 cm

RULER-SHAPED STICKY NOTES

- 30 transparent sheets
- Material: PET

FOGLIETTI ADESIVI A FORMA DI RIGHELLO

- 30 foglietti trasparenti
- Materiale: PET

FEUILLES ADHÉSIVES EN FORME DE RÈGLE

- 30 feuilles transparentes
- Matériau : PET

HOJAS ADHESIVAS EN FORMA DE REGLA

- 30 hojas transparentes
- Material: PET

KLEBEZETTEL IN FORM EINES LINEALS

- 30 transparente Zettel
- Material: PET

PACKAGING
carded
L 6.5 x H 16 cm

**DISPLAY**

material: cardboard
L 16.5 x H 14 x W 7 cm
30 PCS

HRKIT1

30 transparent sheets

JUST MY TYPE

L 3.7 x H 7.8 x W 2.5 cm

ROTATING STAMP WITH INK PAD

- 12 different messages
- Material: plastic handle, soft rubber stamp

TIMBRO GIREVOLE CON TAMPONE INCHIOSTRO

- 12 diversi messaggi
- Materiale: manico in plastica, stampino in gomma morbida

TAMPON ROTATIF AVEC ENCREUR

- 12 messages différents
- Matériau : manche en plastique, timbre en caoutchouc souple

SELLO GIRATORIO CON TAMPÓN DE TINTA

- 12 mensajes distintos
- Material: mango de plástico, sello de goma blanda

DREHBARER STEMPEL MIT STEMPELKISSEN

- 12 verschiedene Nachrichten
- Material: Griff aus Kunststoff, Stempelkissen aus weichem Gummi

PACKAGING
carded
L 11.5 x H 14 cm

**DISPLAY**

material: cardboard
L 15 x H 25 x W 20 cm
6 PCS

ROTKIT1

KEEP IN MIND

L 7 x H 8.4 x W 0.5 cm

ADHESIVE PAGE MARKERS

- 30 writeable and removable adhesive strips per colour

SEGNAPAGINA ADESIVI

- 30 foglietti adesivi per colore, scrivibili e rimovibili

MARQUE-PAGES ADHÉSIFS

- 30 pièces autocollantes par couleur, inscriptibles et détachables

MARCAPÁGINAS ADHESIVOS

- 30 notas adhesivas de cada color, escribibles y separables

KLEBESEITENMARKIERER

- 30 Klebezettel pro Farbe, beschreibbar und wieder entfernbar

PACKAGING

carded
L 7 x H 12.7 cm



DISPLAY

material: cardboard
L 7.5 x H 20.8 x W 15.5 cm

12 PCS

KIMKIT3



8 051128 754407



PACKAGING

carded
L 7 x H 12.7 cm



DISPLAY

material: cardboard
L 7.5 x H 20.8 x W 15.5 cm

12 PCS

KIMKIT4



8 051128 754414



ONCE UPON A TIME

L 8.3 x H 11 x W 2.8 cm

MINI BOOK BOX

- Magnetic clasp
- Material: cardboard

SCATOLA LIBRO MINI

- Apertura e chiusura magnetica
- Materiale: cartone

MINI BOÎTE LIVRE

- Ouverture et fermeture magnétique
- Matériau: carton

CAJA LIBRO MINI

- Apertura y cierre magnético
- Material: cartón

MINI-BUCHSCHACHETEL

- Magnetverschluss
- Material: Karton



DISPLAY

material: cardboard
L 9.5 x H 19 x W 15.5 cm

5 PCS

BOOKKIT3



8 051128 750539



DISPLAY

material: cardboard
L 9.5 x H 19 x W 15.5 cm

5 PCS

BOOKKIT4



8 051128 750546



CALCOOLATOR



L 6 x H 12.5 x W 1.3 cm

CALCULATOR

- Two-way-power system: provides power even when there is no light
- Material: plastic

CALCOLATRICE

- Sistema Two-way-power: fornisce energia anche in situazioni di assenza di luce
- Materiale: plastica

CALCULATRICE

- Système d'alimentation bidirectionnel : système capable d'alimenter la calculatrice, même en absence de lumière
- Matériau : plastique

CALCULADORA

- Sistema Two-way-power: proporciona energía incluso en ausencia de luz
- Material: plástico

TASCHENRECHNER

- Die duale Stromversorgung stellt sicher, dass der Taschenrechner auch ohne Licht funktioniert
- Material: Kunststoff

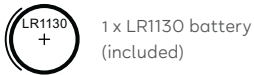

FLORA

8-digit display

PACKAGING

PVC box w/hook
L 6.5 x H 15 x W 1.5 cm

DISPLAY

material: cardboard
L 7 x H 22 x W 13.5 cm
8 PCS



MATH

PACKAGING

PVC box w/hook
L 6.5 x H 15 x W 1.5 cm

DISPLAY

material: cardboard
L 7 x H 22 x W 13.5 cm
8 PCS



BRUSH MARKERS



Ø 1 cm, H 16.8 cm

SET OF 12 BRUSH MARKERS

- Flexible nylon fibre tip: for smooth lines and variable widths

SET DI 12 PENNARELLI CON PUNTA PENNELLO

- Punta flessibile in fibra di nylon: per tratti fluidi e larghezze variabili

SET DE 12 FEUTRES À POINTE PINCEAU

- Pointe flexible en fibre de nylon : dessinez en toute fluidité et variez la largeur du trait en toute simplicité

SOLD X 6

SET DE 12 ROTULADORES CON PUNTA DE PINCEL

- Punta flexible de fibra de nylon: para trazos fluidos y anchos variables

SET AUS 12 PINSELMARKERN

- Flexible Spitze aus Nylonfaser: Für flüssige Striche mit unterschiedlicher Stärke

PACKAGING

PP box w/hook
L 10 x H 19 x W 3 cm

BUMA0001



HIGHLIGHTERS

TEDDY'S MOOD

Ø 1 cm, H 7.5 cm

SET OF 6 MINI HIGHLIGHTERS

SET DI 6 MINI EVIDENZIATORI

SET DE 6 MINI SURLIGNEURS

SET DE 6 MINI SUBRAYADORES

SET AUS 6 MINI-TEXTMARKERN

PACKAGING
PET box w/hook
L 6.8 x H 10.8 x
W 1.2 cm



DISPLAY
material: cardboard
L 14 x H 17.2 x W 8 cm
12 PCS

MHKIT3



PINK



VIOLET



SKY BLUE



GREEN



YELLOW



ORANGE



TEDDY'S STYLE

Ø 1 cm, H 7.5 cm

SET OF 6 MINI HIGHLIGHTERS

SET DI 6 MINI EVIDENZIATORI

SET DE 6 MINI SURLIGNEURS

SET DE 6 MINI SUBRAYADORES

SET AUS 6 MINI-TEXTMARKERN



PACKAGING
PET box w/hook
L 6.8 x H 10.8 x
W 1.2 cm



DISPLAY
material: cardboard
L 14 x H 17.2 x W 8 cm
12 PCS

MHKIT4



YELLOW



PEACH



PINK



LILAC



LIGHT BLUE



LIGHT GREEN



TAPES

TEENY-WEENY TAPE GUN

L 8 x H 12 x W 3 cm

ADHESIVE TAPE GUN

- Includes one 18 mm x 25 m roll of adhesive tape
- Serrated cutting blade
- Ergonomic handle

DISPENSER PER NASTRO ADESIVO

- Include 1 rotolo di nastro adesivo 18 mm x 25 m
- Lama di taglio seghettata
- Impugnatura ergonomica

DÉROULEUR DE RUBAN ADHÉSIF

- Un rouleau de ruban adhésif 18 mm x 25 m inclus
- Lame de découpage dentelée
- Poignée ergonomique

DISPENSADOR DE CINTA ADHESIVA

- Incluye 1 rollo de cinta adhesiva 18 mm x 25 m
- Cuchilla de corte con dientes de sierra
- Empuñadura ergonómica

ABROLLGERÄT FÜR KLEBEBAND

- Inklusive 1 Klebebandrolle 18 mm x 25 m
- Gezackte Schneide Klinge
- Ergonomischer Griff

PACKAGING

clamshell
L 14 x H 20.5 x W 4 cm
SOLD X 3



MTG0001



8 051122 264100



MTG0002



8 051122 264117



MTG0003



8 051122 264124

TAPE BY TAPE

Ø 4.5 cm, H 1.5 cm

SET OF 3 COLOURFUL PAPER STICKY TAPES

- Length: 10 metres

SET DI 3 COLORATISSIMI SCOTCH DI CARTA

- Lunghezza: 10 metri

SET DE 3 RUBANS ADHÉSIFS EN PAPIER EN COULEURS

- Longueur : 10 mètres

SET DE 3 CINTAS DE PAPEL DE COLORES

- Longitud: 10 metros

SET AUS 3 BUNTEN PAPIER-KLEBEBÄNDERN

- Länge: 10 Meter

PACKAGING

window box
L 5 x H 7 x W 5 cm



UNICORN DREAM

DISPLAY

material: cardboard
L 11 x H 15.5 x W 16 cm
6 PCS

TAPUNKIT1



8 051128 755619



PACKAGING

window box
L 5 x H 7 x W 5 cm



PANDA & FRIENDS

DISPLAY

material: cardboard
L 11 x H 15.5 x W 16 cm
6 PCS

TAPPANKIT3



8 051128 755626



PACKAGING

window box
L 5 x H 7 x W 5 cm



JUNGLE

DISPLAY

material: cardboard
L 11 x H 15.5 x W 16 cm
6 PCS

TAPJUNKIT4



8 051128 755633



CORRECTION TAPES

UNICORN SLURP

Ø 3, H 6.5 cm

CORRECTION TAPE

- Excellent coverage
- Can be written on immediately
- Material: plastic

CORRETTORE A NASTRO

- Altamente coprente
- Subito riscrivibile
- Materiale: plastica

ROULEAU CORRECTEUR

- Parfaitement couvrant
- Réécriture immédiate
- Matériau : plastique

CINTA CORRECTORA

- Gran cobertura
- Se puede volver a escribir de inmediato
- Material: plástico

KORREKTUR-ROLLER

- Hochdeckend
- Sofort überschreibbar
- Material: Kunststoff

LENGTH
6
METERS



DISPLAY

material: cardboard
L 15.7 x H 20.5 x W 15 cm

8 PCS

CTICEKIT1



PACKAGING

carded
L 7.3 x H 12.5 x W 3.5 cm



MEOW

L 2.7 x H 5.8 x W 1.5 cm

CORRECTION TAPE

- Excellent coverage
- Can be written on immediately
- Material: plastic

CORRETTORE A NASTRO

- Altamente coprente
- Subito riscrivibile
- Materiale: plastica

ROULEAU CORRECTEUR

- Parfaitement couvrant
- Réécriture immédiate
- Matériau : plastique

CINTA CORRECTORA

- Gran cobertura
- Se puede volver a escribir de inmediato
- Material: plástico

KORREKTUR-ROLLER

- Hochdeckend
- Sofort überschreibbar
- Material: Kunststoff

LENGTH
6
METERS



DISPLAY

material: cardboard
L 13.3 x H 16.5 x W 10 cm

12 PCS

CTCATKIT1



PACKAGING

carded
L 6 x H 11 x W 1.7 cm



DON'T WORRY

L 6.5 x H 6.5 x W 1.5 cm

CORRECTION TAPE

- Excellent coverage
- Can be written on immediately
- Material: plastic

CORRETTORE A NASTRO

- Altamente coprente
- Subito riscrivibile
- Materiale: plastica

ROULEAU CORRECTEUR

- Parfaitement couvrant
- Réécriture immédiate
- Matériau : plastique

CINTA CORRECTORA

- Gran cobertura
- Se puede volver a escribir de inmediato
- Material: plástico

KORREKTUR-ROLLER

- Hochdeckend
- Sofort überschreibbar
- Material: Kunststoff

LENGTH
5+5
METERS



Double tape:
ivory and white

DISPLAY

material: cardboard
L 11 x H 22.7 x W 20.8 cm

10 PCS

CRKIT2



PACKAGING

carded
L 10.5 x H 12 cm



LIKE MAGIC

Ø 2 cm, L 7.5 cm

CORRECTION TAPE

- Excellent coverage
- Can be written on immediately
- Material: plastic

CORRETTORE A NASTRO

- Altamente coprente
- Subito riscrivibile
- Materiale: plastica

ROULEAU CORRECTEUR

- Parfaitement couvrant
- Réécriture immédiate
- Matériau : plastique

CINTA CORRECTORA

- Gran cobertura
- Se puede volver a escribir de inmediato
- Material: plástico

KORREKTUR-ROLLER

- Hochdeckend
- Sofort überschreibbar
- Material: Kunststoff

INDIVIDUAL DESIGNS: SOLD X 8

LENGTH
4
METERS



CCR0001



CCR0002



CCR0003



GLUE TAPES

NEW

Stationery

MEOW

L 2 x H 10 x W 1.8 cm

GLUE TAPE

- Adhesive tape with honeycomb structure, 3 metres long per side
- Material: plastic

COLLA A NASTRO

- Nastro adesivo con struttura a nido d'ape lungo 3 metri per lato
- Materiale: plastica

ROLLER DE COLLE

- Ruban adhésif avec structure en nid d'abeille de 3 mètres de long par côté
- Matériau : plastique

PEGAMENTO EN CINTA

- Cinta adhesiva con estructura de panal de abeja con una longitud de 3 metros por lado
- Material: plástico

KLEBEROLLER

- Kleberoller mit Wabenstruktur, Länge 3 Meter auf jeder Seite
- Material: Kunststoff

PACKAGING

carded
L 6.5 x H 16.5 x W 1.9 cm

DISPLAY

material: cardboard
L 14.5 x H 22 x W 10.5 cm
12 PCS

GLCATKIT1

8 051128 755282

LENGTH
3+3
METERS



Clean application



Solvent-free



Strong and permanent adhesion

RULERS

NEW

MEOW

L 15 cm

RULER

- Material: plastic

RIGHELLO

- Materiale: plastica

RÈGLE

- Matériau : plastique

REGLA

- Material: plástico

LINEAL

- Material: Kunststoff

PACKAGING

OPP bag w/ cardboard
L 3 x H 21 x W 0.5 cm

DISPLAY

material: PET
Ø 9 cm, H 21 cm
20 PCS

RUCATKIT1

8 051128 755299



PAPER WORLD

LOVELY NOTES

L 7 x H 7.2 x W 1.2 cm

ADHESIVE NOTEPAD

- 100 removable and repositionable sticky notes
- 90 g/m² paper

BLOCCHETTO NOTE ADESIVO

- 100 foglietti adesivi removibili e riposizionabili
- Carta 90 g/m²

BLOC-NOTES ADHÉSIF

- 100 petites feuilles adhésives détachables et repositionnables
- Papier 90 g/m²

BLOC DE NOTAS ADHESIVO

- 100 papeles adhesivos extraíbles y recolocables
- Papel de 90 g/m²

HAFTNOTIZBLOCK

- 100 wieder entfernbare und neu positionierbare Klebezettel
- Papier 90 g/m²



DISPLAY

material: cardboard
L 9 x H 14.7 x W 15 cm
12 PCS

HSSKIT1



8 051128 754766



HAPPY MEMO

L 9 x H 8.2 x W 9 cm

MEMO CUBE

- 700 white tear-off sheets
- 100 g/m² paper

BLOCCO NOTE

- 700 fogli bianchi staccabili
- Carta 100 g/m²

BLOC-MÉMO

- 700 feuilles blanches détachables
- Papier 100 g/m²

CUBO DE NOTAS

- 700 hojas blancas separables
- Papel de 100 g/m²

NOTIZBLOCK

- 700 abtrennbare weiße Zettel
- Papier 100 g/m²

SOLD X 2



The mark of responsible forestry

FSC®
CERTIFIED PAPER



HM0001



8 056304 485861



HM0003



8 056304 485885



HM0004



8 056304 485892



HM0007



8 052461 966052

STICKY NOTE SET

L 18.6 x H 15.7 cm

STICKY NOTE SET

- Set of 8 pads of adhesive removable notes
- 100 sheets per pad
- Rigid backing card

SET DI FOGLIETTI ADESIVI

- Set di 8 blocchetti note adesivi e removibili
- 100 fogli per ogni blocchetto
- Supporto in cartoncino rigido

SET DE PETITES FEUILLES ADHÉSIVES

- Set de 8 petits bloc-notes adhésifs et avec feuilles détachables
- 100 feuilles par bloc
- Supporte en carton rigide

SET DE HOJAS ADHESIVAS

- Set de 8 blocs de notas adhesivas y separables
- 100 folios por bloc
- Soporte de cartón rígido

KLEBEZETTEL-SET

- Set aus 8 Blocks mit wieder entfernbaren Klebezetteln
- 100 Blätter pro Block
- Basis aus stabilem Karton

✳ While stock lasts

SOLD X 3

SNS0001 ✳



8 051122 265084



SNS0002



8 051122 265091





SMART NOTES

L 25 x H 17 cm

PAPER MOUSEPAD & NOTEPAD

- 55 tear-off sheets
- 80 g/m² paper

TAPPETINO PER IL MOUSE IN CARTA & BLOCK-NOTES

- 55 fogli staccabili
- Carta 80 g/m²

TAPIS DE SOURIS EN PAPIER & BLOC-NOTES

- 55 feuilles détachables
- Papier 80 g/m²

ALFOMBRILLA DE PAPEL PARA RATÓN & BLOC DE NOTAS

- 55 hojas separables
- Papel de 80 g/m²

MOUSEPAD AUS PAPIER & SCHREIBBLOCK

- 55 abtrennbare Zettel
- Papier 80 g/m²

* While stock lasts

SOLD X 2



FSC®
CERTIFIED PAPER

The mark of responsible forestry



SMANT0001



SMANT0007 *



SMANT0009



SMANT0010



SMANT0012



SMANT0013



SMANT0014



PAPER THOUGHTS

L 11 x H 19 cm / L 19 x H 11 cm

NOTEPAD

- 70 tear-off sheets
- 80 g/m² paper

BLOCK-NOTES

- 70 fogli staccabili
- Carta 80 g/m²

BLOC-NOTES

- 70 feuilles détachables
- Papier 80 g/m²

BLOC DE NOTAS

- 70 hojas separables
- Papel de 80 g/m²

SCHREIBBLOCK

- 70 abtrennbare Zettel
- Papier 80 g/m²

* While stock lasts

SOLD X 3



FSC®
CERTIFIED PAPER

The mark of responsible forestry



PT0004



PT0007



PT0012 *



PT0013



PT0008



PT0011



SMART PLANNING

L 34 x H 8 cm

DESK PLANNER

- 55 tear-off sheets
- 80 g/m² paper

PLANNING DA SCRIVANIA

- 55 fogli staccabili
- Carta 80 g/m²

PLANNER DE BUREAU

- 55 feuilles détachables
- Papier 80 g/m²

SOLD X 2



FSC®
CERTIFIED PAPER

The mark of
responsible forestry

AGENDA DE ESCRITORIO

- 55 hojas separables
- Papel de 80 g/m²

SCHREIBTISCHKALENDER

- 55 abtrennbare Zettel
- Papier 80 g/m²



SMAPL07



8 058093 948954



SMAPL13



8 058093 949012



SMAPL15



8 051739 307542



SMAPL16



8 051739 307559

SMART WEEK

L 34 x H 24 cm

DESK PLANNER

- 55 tear-off sheets
- 80 g/m² paper

PLANNING DA SCRIVANIA

- 55 fogli staccabili
- Carta 80 g/m²

PLANNER DE BUREAU

- 55 feuilles détachables
- Papier 80 g/m²

AGENDA DE ESCRITORIO

- 55 hojas separables
- Papel de 80 g/m²

SCHREIBTISCHKALENDER

- 55 abtrennbare Zettel
- Papier 80 g/m²

SOLD X 2



FSC®
CERTIFIED PAPER

The mark of
responsible forestry



DW0001



8 051739 307566



DW0002



8 051739 307573



DW0003



8 051739 307580



DW0004



8 051739 307597





MANILA FOLDERS

L 31.5 x H 24 cm

SET OF 5 MANILA FOLDERS

- Perfect for storing any type of A4 document
- Made of durable 350 g/m² cardboard

KIT DA 5 CARTELLINE PORTADOCUMENTI

- Perfette per archiviare ogni tipo di documento in formato A4
- Realizzate in resistente cartoncino da 350 g/m²

SET DE 5 CHEMISES PORTE-DOCUMENTS

- Parfaites pour classer tout type de document au format A4
- Réalisées en carton résistant de 350 g/m²

KIT DE 5 CARPETAS PORTADOCUMENTOS

- Perfectas para archivar cualquier tipo de documento en formato A4
- Realizadas en cartón resistente de 350 g/m²

SET MIT 5 AKTENDECKELN

- Insbesondere zum Archivieren von verschiedenen Dokumenten im Format A4 geeignet
- Hergestellt aus haltbarem Karton mit 350 g/m²

PACKAGING

shrink-wrapping
w/paper card
L 31.5 x H 24 x W 0.8 cm



The mark of
responsible forestry

FSC®
CERTIFIED PAPER

SOLD X 2



FOL0001



FOL0002



FOL0003



FOL0004



TAKE NOTE

L 23 x H 32 x W 1.5 cm (closed)

CLIPBOARD FOLDER

- 1 pad of 40 sheets included (21.5 x 29.7 cm)
- Inside pocket to hold documents
- Material: metal, paper

CARTELLA PORTADOCUMENTI CON CLIP

- 1 blocco da 40 fogli incluso (21,5 x 29,7 cm)
- Taschina interna portadocumenti
- Materiale: metallo, carta

PORTE-DOCUMENTS AVEC PINCE

- 1 bloc de 40 feuilles inclus (21,5 x 29,7 cm)
- Poche intérieure porte-documents
- Matériau : métal, papier

CARPETA PORTADOCUMENTOS CON CLIP

- 1 bloc de 40 folios incluido (21,5 x 29,7 cm)
- Bolsillo interno portadocumentos
- Material: metal, papel

DOKUMENTENMAPPE MIT CLIP

- 1 Block mit 40 Blättern enthalten (21,5 x 29,7 cm)
- Innentasche für Dokumente
- Material: Metall, Papier

SOLD X 3

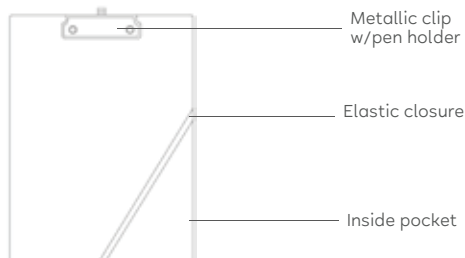

LINED
CPF0001



SILVER FOIL

DOTTED
CPF0002



SQUARED
CPF0003



BOOKMARKS

GOLD/SILVER FOIL

BOOKMARK

L 4.7 x H 17.5 cm

BOOKMARK

- With elastic pagemaker, also useful for keeping your book closed

SEGNALIBRO

- Con elastico segnapagina, utile anche per tenere il libro chiuso

MARQUE-PAGE

- Marque-page avec élastique, également utile pour maintenir le livre fermé

MARCALIBROS

- Con elástico marcapáginas, útil incluso para tener el libro cerrado

LESEZEICHEN

- Mit elastischem Seitenmarkierer, nützlich auch, um das Buch geschlossen zu halten

* While stock lasts



FSC®
CERTIFIED PAPER

The mark of responsible forestry

PACKAGING

OPP bag w/hook
L 5.5 x H 19.5 cm

SOLD X 3



EMPTY DISPLAY ON DEMAND

material: metal
Ø 23 cm, H 46 cm
14 hooks
(hook capacity: 12 pcs)
total capacity: 168 pcs



DISWIRW

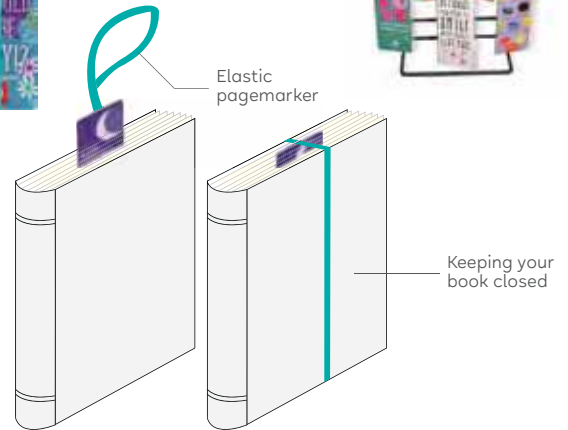

BOOK LOVER'S COLLECTION



SE0159



SE0160 *



SE0165



SE0166



SE0168



SE0170



SE0174



SE0181



SE0182



SE0184



SE0190



SE0192 *



SE0193 *



SE0194





SE0195



SE0196



SE0197



SE0199



SE0200 ✨



SE0201



SE0203 ✨



SE0206



SE0207



SE0208



SE0209



SE0210



NEW

SE0227



NEW

SE0228



NEW

SE0229



NEW

SE0230



NEW

SE0231



NEW

SE0232





NEW

SE0233



NEW

SE0234



NEW

SE0235



NEW

SE0236



NEW

SE0237



NEW

SE0238



NEW

SE0239



NEW

SE0240



NEW

SE0241



NEW

SE0242



APHORISMS COLLECTION

ITALIAN MARKET



SE0078



SE0081 ✨



SE0082 ✨



SE0084



SE0088



SE0186





SE0187



8 056304 482907



SE0212



8 052783 614471



SE0213



8 052783 614488



SE0214



8 052783 614495



SE0215



8 052783 614501



SE0216



8 052783 614518



SE0217



8 052783 614525



SE0218



8 052783 614532



SE0219



8 052783 614549



SE0220



8 052783 614556



SE0221



8 052783 614563



SE0222



8 052783 614570



SE0223



8 052783 614587



SE0224



8 052783 614594



SE0225



8 052783 614600



SE0226



8 052783 614617

SLOW READERS CLUB

L 9.8 x H 11.4 x W 1.5 cm

BOOKMARK

- Material: plastic

SEGNALIBRO

- Materiale: plastica

MARQUE-PAGE

- Matériau : plastique

MARCAPÁGINAS

- Material: plástico

LESEZEICHEN

- Material: Kunststoff



PACKAGING
cardboard box
L 11 x H 15.7 x
W 2 cm



DISPLAY

material: cardboard
L 12 x H 23.5 x W 25 cm

7 PCS

SLOTHKIT1



HUNGRY FOR BOOKS

L 11.5 x H 6.5 cm

BOOKMARK

- Material: plastic

SEGNALIBRO

- Materiale: plastica

MARQUE-PAGE

- Matériau : plastique

MARCAPÁGINAS

- Material: plástico

LESEZEICHEN

- Material: Kunststoff



PACKAGING
cardboard box
L 14.5 x H 11.5 x
W 2.5 cm



DISPLAY

material: cardboard
L 15.5 x H 21.5 x W 19 cm

7 PCS

SHARKKIT1



NEVER STOP READING

L 2.5 x H 4.5 cm

SET OF 4 MAGNETIC BOOKMARKS

- Material: paper, plastoferrite

SET DI 4 SEGNALIBRI MAGNETICI

- Materiale: carta, plastoferrite

SET DE 4 MARQUE-PAGES MAGNÉTIQUES

- Matériau : papier, plastoferrite

SET DE 4 MARCAPÁGINAS MAGNÉTICOS

- Material: papel, imanes plásticos

SET MIT 4 MAGNETISCHEN LESEZEICHEN

- Material: Papier, Plastoferrit

PACKAGING
carded
L 8 x H 14.5 cm



DISPLAY

material: cardboard
L 8.5 x H 23 x W 15.5 cm

12 PCS

MBOOKKIT2



FOLLOW THE SKYLINE

L 20 x H MAX 5 cm

RULER

• Material: acrylic

RIGHELLO

• Materiale: acrílico

RÈGLE

• Matériau : acrylique

REGLA

• Material: acrílico

LINEAL

• Material: Acryl



PACKAGING

OPP bag
w/cardboard
L 22.5 x H 7 cm



DISPLAY

material: cardboard
L 24 x H 9 x W 5.5 cm
12 PCS



ITALY



BERGAMO

SRKIT3



8 051128 752793



FIRENZE

SRKIT4



8 051128 752809



MILANO

SRKIT5



8 051128 752816



ROMA

SRKIT6



8 051128 752823



TORINO

SRKIT7



8 051128 752830



VENEZIA

SRKIT8



8 051128 752847



VERONA

SRKIT9



8 051128 752854



COMO

SRKIT14



8 051128 753165



NAPOLI

SRKIT15



8 051128 753172

WORLD



NEW YORK

SRKIT10



8 051128 752861



BARCELONA

SRKIT11



8 051128 752878



LONDON

SRKIT12



8 051128 752885



PARIS

SRKIT13



8 051128 752892



BERLIN

SRKIT16



8 051128 753189



ISTANBUL

SRKIT17



8 051128 753196



LISBOA

SRKIT18



8 051128 753202

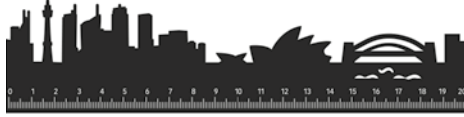

SYDNEY

SRKIT19



8 051128 753219



WIEN

SRKIT20



8 051128 753226

BIBBIDI-BOBBIDI-BOO

ACRYLIC RULER

RIGHELLO IN ACRILICO

RÈGLE EN ACRYLIQUE

REGLA EN ACRÍLICO

LINEAL AUS ACRYL



20 cm



20 cm



30 cm

DISPLAY

material: PET
Ø 7.5 cm, H 14 cm

20 PCS

ARKIT1



8 051128 752779



DISPLAY

material: PET
Ø 7.5 cm, H 14 cm

20 PCS

ARKIT2



8 051128 752786



DISPLAY

material: PET
Ø 7.5 cm, H 14 cm

20 PCS

ARLKIT1



8 051128 752762



FOLDING RULER



L 30 cm (15 cm folded)

ALUMINIUM FOLDING RULER

- Dual use: measures in centimetres (30 cm) and degrees (180°)
- Material: aluminium

RIGHELLO PIEGHEVOLE IN ALLUMINIO

- Doppio utilizzo: misurazione in centimetri (30 cm) e in gradi (180°)
- Materiale: alluminio

RÈGLE PLIABLE EN ALUMINIUM

- Double usage : mesure en centimètres (30 cm) et mesure de degrés (180°)
- Matériau : aluminium

REGLA PLEGABLE DE ALUMINIO

- Doble uso: medición en centímetros (30 cm) y en grados (180°)
- Material: aluminio

KLAPPLINEAL AUS ALUMINIUM

- Doppelte Funktion: Zentimetermessen (30 cm) und Winkelmessen (180°)
- Material: Aluminium

PACKAGING

carded
L 8 x H 20.5 cm



DISPLAY

material: cardboard
L 9.5 x H 21 x W 14 cm

20 PCS

FRKIT2



8 051128 755565



SIZE MATTERS

Ø 1 cm, H 9 cm

MINI BALLPOINT PEN

- Black ink, 0,8 mm tip
- Material: metal

MINI PENNA A SFERA

- Inchiostro nero, punta 0,8 mm
- Materiale: metallo

MINI STYLO À BILLE

- Encre noire, pointe 0,8 mm
- Matériau : métal

MINIBOLÍGRAFO

- Tinta negra, punta de 0,8 mm
- Material: metal

MINI-KUGELSCHREIBER

- Schwarze Tinte, Spitze 0,8 mm
- Material: Metall

SOLD X 6**EMPTY DISPLAY ON DEMAND**

material: cardboard
L 12,5 x H 18 x W 14,5 cm
minimum order qty: 24 pcs

MP0001 DARK BLUE



8 059174 834647

MP0002 AQUA



8 059174 834654

MP0003 PINK



8 059174 834661

MP0004 RED



8 059174 834678

DISMP



8 059174 834685

REFILL TYPE: D1,
AVAILABLE ON THE MARKET

SMART TOUCH

Ø 0.8 cm, H 9.6 cm

MINI TOUCHSCREEN PEN

- Ballpoint pen, black ink, tip diameter 1,0 mm

MINI PENNA TOUCH

- Penna a sfera, inchiostro nero, diametro della punta 1,0 mm

MINI STYLO TACTILE

- Stylo à bille, encre noire, diamètre de la pointe 1,0 mm

MINIBOLÍGRAFO TÁCTIL

- Bolígrafo, tinta negra, diámetro de la punta 1,0 mm

MINI-TOUCHSCREEN-STIFT

- Kugelschreiber, schwarze Tinte, Durchmesser der Spitze 1,0 mm

SOLD X 6**EMPTY DISPLAY ON DEMAND**

material: cardboard
L 12,5 x H 18 x W 14,5 cm
minimum order qty: 24 pcs

PWT0001 BLACK



8 051739 305289

PWT0002 PETROL BLUE



8 051739 305296

PWT0003 BLUE



8 051739 305302

PWT0004 PINK



8 051739 305319

DISPWT



8 051739 305326

REFILL TYPE: D1,
AVAILABLE ON THE MARKET

GEL INK PEN

Ø 1 cm, H 14.2 cm

GEL PEN

- Tip diameter 0,7 mm

PENNA GEL

- Diametro della punta 0,7 mm

STYLO À ENCRE GEL

- Diamètre de la pointe 0,7 mm

BOLÍGRAFO DE GEL

- Diámetro de la punta 0,7 mm

GELSTIFT

- Durchmesser der Spitze 0,7 mm



RED INK

DISPLAY
material: PET
Ø 7,5 cm, H 14,5 cm
30 PCS

GELKIT3



8 051128 751062

BLACK INK

DISPLAY
material: PVC
Ø 7,3 cm, H 14,6 cm
30 PCS

GELKIT4



8 051128 754698

BLUE INK

DISPLAY
material: PVC
Ø 7,3 cm, H 14,6 cm
30 PCS

GELKIT5



8 051128 754704

INITIAL PEN

Ø 0.7 cm, H 13.5 cm

BALLPOINT PEN

- Black ink, 1.0 mm tip
- Material: metal

PENNA A SFERA

- Inchiostro nero, punta 1,0 mm
- Materiale: metallo

STYLO À BILLE

- Encre noire, pointe 1,0 mm
- Matériau : métal

INDIVIDUAL DESIGNS: SOLD X 1

BOLÍGRAFO

- Tinta negra, punta de 1,0 mm
- Material: metal

KUGELSCHREIBER

- Schwarze Tinte, Spitze 1,0 mm
- Material: Metall

FIRST ORDER: MOQ 1 FULL ASSORTED DISPLAY (100 PCS)

material: acrylic
L 12.7 x H 14 x W 13.5 cm

ASSORTMENT:

- 6 PCS: A, E, L, M, S
- 5 PCS: B, C, D, F, G, I, R
- 4 PCS: N, O, P, T, V
- 3 PCS: J
- 2 PCS: H, K, W, Z
- 1 PC: Q, U, X, Y



ALPHAKIT1



ALPHA0001

8 052783 612118



ALPHA0002

8 052783 612125



ALPHA0003

8 052783 612132



ALPHA0004

8 052783 612149



ALPHA0005

8 052783 612156



ALPHA0006

8 052783 612163



ALPHA0007

8 052783 612170



ALPHA0008

8 052783 612187



ALPHA0009

8 052783 612194



ALPHA0010

8 052783 612200



ALPHA0011

8 052783 612217



ALPHA0012

8 052783 612224



ALPHA0013

8 052783 612231



ALPHA0014

8 052783 612248



ALPHA0015

8 052783 612255



ALPHA0016

8 052783 612262



ALPHA0017

8 052783 612279



ALPHA0018

8 052783 612286



ALPHA0019

8 052783 612293



ALPHA0020

8 052783 612309



ALPHA0021

8 052783 612316



ALPHA0022

8 052783 612323



ALPHA0023

8 052783 612330



ALPHA0024

8 052783 612347



ALPHA0025

8 052783 612354



ALPHA0026

8 052783 612361

WRITE DOWN

Ø 8 cm, H 20 cm

DESK PEN

- 360° pen rotation
- Compatible with standard refill
- Black ink, 1.0 mm tip
- Material: iron, plastic

PENNA DA SCRIVANIA

- Rotazione penna a 360°
- Ricaricabile con refill standard
- Inchiostro nero, punta 1,0 mm
- Materiale: metallo, plastica

STYLO DE BUREAU

- Rotation du stylo à 360°
- Rechargeable avec une recharge de stylo standard
- Encre noire, pointe 1,0 mm
- Matériau : métal, plastique

BOLÍGRAFO DE ESCRITORIO

- Rotación del bolígrafo de 360°
- Recargable con recarga estándar
- Tinta negra, punta de 1,0 mm
- Material: metal, plástico

SCHREIBTISCH-STIFT

- 360°-Stiftdrehung
- Wiederauffüllbar mit Standardpatrone
- Schwarze Tinte, Spitze 1,0 mm
- Material: Metal, Kunststoff



DEP0001 ROSE GOLD



8 052783 619025

DEP0002 BLACK



8 052783 619049

PACKAGING cardboard box L 7.8 x H 16.5 x W 3 cm
SOLD X 3

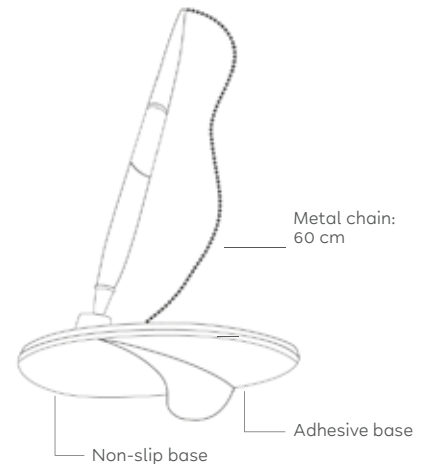

JUMBO 2-COLOUR PENCIL

Ø 1 cm, H 17.5 cm

JUMBO 2-COLOUR PENCIL

PASTELLO JUMBO 2 COLORI

CRAYON DE COULEUR JUMBO BICOLORES

LÁPIZ JUMBO 2 COLORES

JUMBO-BUNTSTIFT 2 FARBEN

* While stock lasts

WOOD FROM CERTIFIED FOREST SOURCES

ORANGE & APPLE GREEN



FUCHSIA & BLUE



LIGHT BROWN & PURPLE



BROWN & LIGHT BLUE



YELLOW & BLACK



RED & BLUE



DISPLAY
material: PET
Ø 8 cm, H 17.5 cm
36 PCS

DISPLAY
material: PET
Ø 8 cm, H 17.5 cm
36 PCS

DISPLAY
material: PET
Ø 8 cm, H 17.5 cm
36 PCS

DISPLAY
material: PET
Ø 8 cm, H 17.5 cm
36 PCS

DISPLAY
material: PET
Ø 8 cm, H 17.5 cm
36 PCS

DISPLAY
material: PET
Ø 8 cm, H 17.5 cm
36 PCS

BIKIT2 *



8 051128 750713

BIKIT3



8 051128 750720

BIKIT4



8 051128 750737

BIKIT5



8 051128 750744

BIKIT6



8 051128 750751

BIKIT7



8 051128 753080

LIFE IS BETTER IN...

Ø 1.2 cm, H 18 cm

JUMBO FLOURESCENT PENCIL

PASTELLO JUMBO FLUO

CRAYON DE COULEUR JUMBO FLUO

LÁPIZ JUMBO COLORES FLUORESCENTES

FLUORESZIERENDER JUMBO-BUNTSTIFT



DISPLAY
material: PET
Ø 8 cm, H 17.5 cm
36 PCS

DISPLAY
material: PET
Ø 8 cm, H 17.5 cm
36 PCS

DISPLAY
material: PET
Ø 8 cm, H 17.5 cm
36 PCS

DISPLAY
material: PET
Ø 8 cm, H 17.5 cm
36 PCS

DISPLAY
material: PET
Ø 8 cm, H 17.5 cm
36 PCS

FLUKIT1 YELLOW



8 051128 750652

FLUKIT2 PINK



8 051128 750669

FLUKIT3 GREEN



8 051128 750676

FLUKIT4 ORANGE



8 051128 750683

FLUKIT5 BLUE



8 051128 750690

OVER THE RAINBOW

Ø 1 cm, H 17.5 cm

MULTICOLOUR PENCIL CRAYON

- 4-colour triangular pencil

PASTELLO MULTICOLORE

- Pastello triangolare a 4 colori

CRAYON MULTICOLORE

- Crayon triangulaire à 4 couleurs

LÁPIZ MULTICOLOR

- Lápiz triangular con mina de 4 colores

MULTICOLOUR-BUNTSTIFT

- Vierfarbiger Buntstift mit dreieckigem Querschnitt



DISPLAY

material: PET
Ø 8 cm, H 17.5 cm

36 PCS

OVEKIT1



8 051128 750423



BLACK PENCIL

Ø 1 cm, H 19.5 cm

PENCIL WITH ERASER

- HB lead

MATITA CON GOMMA

- Mina HB

CRAYON AVEC GOMME

- Mine HB

LÁPIZ CON GOMA

- Mina HB

BLEISTIFT MIT RADIERGUMMI

- HB-Mine



DISPLAY

material: PET
Ø 8 cm, H 19.5 cm

36 PCS

BPKIT1



8 051128 750461



PENCIL-RULER

Ø 1 cm, H 17.5 cm

PENCIL-RULER

- HB lead

MATITA RIGHELLO

- Mina HB

CRAYON RÈGLE

- Mine HB

LÁPIZ REGLA

- Mina HB

BLEISTIFT-LINEAL

- HB-Mine



DISPLAY

material: PET
Ø 7.5 cm, H 17.5 cm

36 PCS

RULKIT1



8 051128 750607



CUTTING LINE

L 6.5 x H 20 cm

STAINLESS STEEL SCISSORS

- Stainless steel blades guarantee exceptional durability and outstanding cutting performance

FORBICI IN ACCIAIO INOSSIDABILE

- Lame in acciaio inossidabile per garantire un'eccezionale durata e un'ottima prestazione di taglio

CISEAUX EN ACIER INOXYDABLE

- Lames en acier inoxydable pour garantir une durée exceptionnelle et une haute performance de coupe

TIJERAS EN ACERO INOXIDABLE

- Cuchillas en acero inoxidable para garantizar una excepcional duración y un óptimo resultado de corte

SCHERE AUS EDELSTAHL

- Die Klingen aus rostfreiem Stahl garantieren eine außergewöhnliche Dauerhaftigkeit und eine hervorragende Schneidleistung



PACKAGING

PP box w/hook
L 8 x H 22 x W 1 cm

SOLD X 4

SCIS0001



PEN SCISSORS

Ø 1.3 cm, H 11.3 cm

PEN SCISSORS

- Small and compact
- Perfect for taking everywhere with you
- Material: plastic, metal

FORBICI A FORMA DI PENNA

- Piccole e compatte
- Perfette da portare sempre con sé
- Materiale: plastica, metallo

CISEAUX AU FORMAT STYLO

- Petite paire de ciseaux compacts
- Idéale pour toujours vous accompagner
- Matériau : plastique, métal

TIJERAS EN FORMA DE BOLÍGRAFO

- Pequeñas y compactas
- Perfectas para llevarlas siempre contigo
- Material: plástico, metal

SCHERE IN STIFTFORM

- Klein und kompakt
- Perfekt zum Mitnehmen
- Material: Kunststoff, Metall

INDIVIDUAL COLOURS: SOLD X 6

PACKAGING

carded
L 6 x H 18 x W 1.5 cm



FIRST ORDER: MOQ 1 FULL ASSORTED DISPLAY (12 PCS)

material: cardboard
L 15 x H 24 x W 11 cm

12 PCS: 6 X PS0003, 6 X PS0005

PSKIT2



ROLL UP

L 24,3 x H 19,8 cm (open)

COTTON CANVAS PENCIL CASE

- Adjustable popper closure
- 7 internal compartments of different sizes
- Material: cotton canvas, PE

ASTUCCIO IN COTONE CANVAS

- Chiusura con bottone regolabile
- All'interno 7 spazi di diverse dimensioni
- Materiale: cotone canvas, PE

TROUSSE EN TOILE DE COTON

- Fermeture avec bouton réglable
- À l'intérieur, 7 compartiments de tailles différentes
- Matériau : toile de coton, PE

ESTUCHE EN LONA DE ALGODÓN

- Cierre con botón regulable
- En su interior 7 compartimentos de distintas dimensiones
- Material: lona de algodón, PE

FEDERMÄPPCHEN AUS CANVAS-BAUMWOLLE

- Verschluss mit verstellbarem Knopf
- Innen befinden sich 7 verschieden große Fächer
- Material: Canvas-Baumwolle, PE

PACKAGING

PET box w/hook
L 23,5 x H 6 x W 6 cm
SOLD X 2



Pens and pencils not included



RP0001 BLUE
8 058093 948572



RP0002 RED
8 058093 948589



RP0003 GREY
8 058093 948596

PENCIL CASE

L 20 x H 5 x W 3 cm

SOFT SILICONE PENCIL CASE

- Capacity: about 10 pens
- Dual use: opens up completely or opens up partially thanks to the silicone zip stopper flaps

ASTUCCIO IN MORBIDO SILICONE

- Capacità: circa 10 penne
- Doppio utilizzo: si apre completamente oppure si apre parzialmente grazie alle alette ferma cerniera in silicone

TROUSSE EN SILICONE SOUPLE

- Capacité : environ 10 stylos
- Double utilisation : elle peut s'ouvrir complètement ou partiellement, grâce aux ailettes en silicone de blocage de la fermeture éclair

ESTUCHE DE SILICONA BLANDA

- Capacidad: 10 bolígrafos aproximadamente
- Doble uso: se abre completamente o se abre parcialmente gracias a las aletas de bloqueo en silicona de la cremallera

FEDERMÄPPCHEN AUS WEICHEM SILIKON

- Bietet Platz für: ca. 10 Stifte
- Doppelte Verwendung: Vollständige Öffnung oder teilweise Öffnung dank der Silikonflügel, die als Reißverschluss-Stopper dienen

PACKAGING

PET box w/hook
L 24,5 x H 5 x W 3 cm
SOLD X 3



PCS0004
8 059174 833114

Pens not included



Opens up partially thanks to the silicone zip stopper flaps



Opens up completely

*MORE DESIGNS ON PAGE 177



NO COFFEE NO WORKEE

Ø 8.2 cm, H 13 cm

PEN HOLDER

- Material: beechwood

PORTA PENNE

- Materiale: legno di faggio

PORTE-CRAYONS

- Matériau : bois de hêtre

LAPICERO

- Material: madera de haya

STIFTHALTER

- Material: Buchenholz

**PACKAGING**cardboard box
L 12 x H 20 x W 12 cm**SOLD X 3**

PCH0001

**CALENDAR AND DESK TIDY**

L 12 x H 6 x W 7.5 cm

CALENDAR AND DESK TIDY

- Multi-purpose: perpetual calendar, base for phone, pen holder and business card holder
- Material: beechwood

CALENDARIO E PORTAOGGETTI DA SCRIVANIA

- Multiuso: calendario perpetuo, base per telefono, porta penna e porta biglietti da visita
- Materiale: legno di faggio

CALENDRIER ET ORGANISATEUR DE BUREAU

- Multifonctions : calendrier perpétuel, base pour téléphone portable, porte-stylo et porte-cartes de visite
- Matériau : bois de hêtre

CALENDARIO Y SOPORTE PARA OBJETOS DE ESCRITORIO

- Multiuso: calendario perpetuo, base para teléfono, soporte para bolígrafo y tarjetas de visita
- Material: madera de haya

SCHREIBTISCHKALENDER UND -BOX

- Vielzweckartikel: ewiger Kalender, Basis für das Telefon, Stifthalter und Visitenkartenhalter
- Material: Buchenholz

PACKAGINGcardboard box
L 12.5 x H 6.2 x W 8 cm**SOLD X 3**

WOOD0001

Smartphone, pen and
cards not includedFSC®
CERTIFIED WOODThe mark of
responsible forestry

BINDER CLIPS - MEDIUM

L 3.3 x H 4 cm

SET OF 6 METAL CLIPS

SET DI 6 CLIP IN METALLO

SET DE 6 CLIPS EN MÉTAL

SET DE 6 PINZAS DE METAL

SET MIT 6 METALLCLIPS

PACKAGING

OPP bag w/cardboard

L 9 x H 21 cm

SOLD X 6

BCLIM0001



8 052783 619216

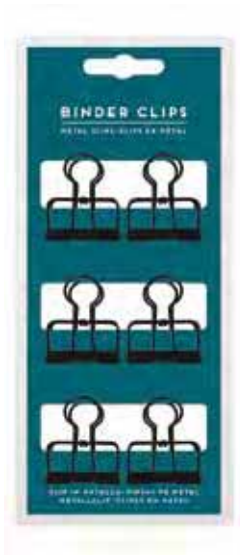

BINDER CLIPS - LARGE

L 5 x H 6.5 cm

SET OF 3 METAL CLIPS

SET DI 3 CLIP IN METALLO

SET DE 3 CLIPS EN MÉTAL

SET DE 3 PINZAS DE METAL

SET MIT 3 METALLCLIPS

PACKAGING

OPP bag w/cardboard

L 9 x H 21 cm

SOLD X 6

BCLIL0001



8 052783 619223

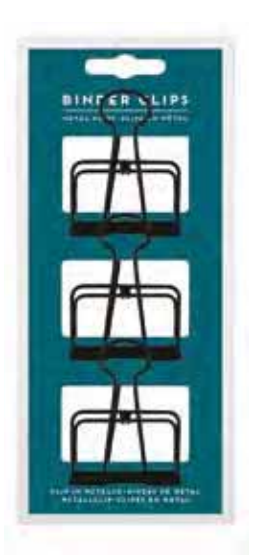

BE SHARP

L 7 x H 1.7 x W 2.7 cm

WOODEN SHARPENER

- 5 holes
- Material: beechwood, metal

TEMPERINO IN LEGNO

- 5 fori
- Materiale: legno di faggio, metallo

TAILLE-CRAYON EN BOIS

- 5 trous
- Matériau : bois de hêtre, métal

SACAPUNTAS DE MADERA

- 5 orificios
- Material: medera de haya, metal

HOLZANSPIZTER

- 5 Löchern
- Material: Buchenholz, Metall



DISPLAY

material: cardboard
L 15.3 x H 11 x W 10 cm

18 PCS

WPSKIT1



8 051739 306125



LET'S ROLL

L 5.5 x H 6.5 x W 4.5 cm

ADHESIVE PAPER STRIPS

- Can be cut to any length you wish
- 2 refills included
- Material: plastic, paper

FOGLIETTI ADESIVI IN CARTA

- Puoi tagliarli alla lunghezza che preferisci
- 2 ricariche incluse
- Materiale: plastica, carta

RUBANS DE PAPIER ADHÉSIF

- Vous pouvez les couper à la longueur que vous souhaitez
- 2 recharges incluses
- Matériau : plastique, papier

HOJAS ADHESIVAS DE PAPEL

- Puedes cortarlas a la longitud que desees
- 2 recargas incluidas
- Material: plástico, papel



RSN0001 LILAC



8 051122 260911

PACKAGING

PET box
L 10 x H 6.5 x W 4.7 cm

SOLD X 3



RSN0002 GREEN



8 051122 260928

Notebook

COLLECTION



QUADERNO

SMALL

L 9 x H 13,5 cm

- 100 g/m² white paper
- 80 pages
- Sewn binding
- Carta bianca 100 g/m²
- 80 pagine
- Rilegatura a punto Singer
- Papier blanc 100 g/m²
- 80 pages
- Reliure par couture Singer

- Papel blanco de 100 g/m²
- 80 páginas
- Encuadernación con cosido Singer
- Weißes Papier 100 g/m²
- 80 Seiten
- Singer-Fadenheftung

LINED



GOLD/SILVER FOIL



SOLD X 3



FSC®
CERTIFIED PAPER

The mark of
responsible forestry



TRAVEL

A6NOT0013



STARS

A6NOT0014



MATH

A6NOT0016



JUNGLE

A6NOT0017



TOUCANS

A6NOT0018



FLAMINGO

A6NOT0019



CHERRY BOMB

A6NOT0020



PANDA

A6NOT0022



MEDIUM

L 14.2 x H 21 cm

- 100 g/m² white paper
- 80 pages
- Sewn binding
- Carta bianca 100 g/m²
- 80 pagine
- Rilegatura a punto Singer
- Papier blanc 100 g/m²
- 80 pages
- Reliure par couture Singer

- Papel blanco de 100 g/m²
- 80 páginas
- Encuadernación con cosido Singer
- Weißes Papier 100 g/m²
- 80 Seiten
- Singer-Fadenheftung

* While stock lasts

SOLD X 3



The mark of responsible forestry

FSC®
CERTIFIED PAPER

LINED

SQUARED

PLAIN



HAPPINESS



N/A



A5NOT0017 *



8 052783 613764



N/A



ORIGAMI



A5NOT0011 *



8 051122 269747



N/A



N/A



NAMASTE



A5NOT0012 *



8 051122 269754



N/A



N/A



TRAVEL



A5NOT0013



8 051122 269761



N/A



A5NOT0023



8 051739 308075



STARS



A5NOT0033



8 052461 962160



N/A



A5NOT0024



8 051739 308082



MATH



A5NOT0034



8 052461 962177



N/A



A5NOT0026



8 051739 308105



JUNGLE



A5NOT0035



8 052461 962184



N/A



A5NOT0027



8 051739 308112



TOUCANS



A5NOT0036



8 052461 962191



N/A



A5NOT0028



8 051739 308129



FLAMINGO



A5NOT0037



8 052461 962207



N/A



A5NOT0029



8 051739 308136



CHERRY BOMB



A5NOT0038



8 052461 962214



N/A



A5NOT0030



8 051739 308143



PANDA



A5NOT0039



8 052461 962221



N/A



A5NOT0032



8 051739 308167

LARGE

L 18.5 x H 24.8 cm

- 100 g/m² white paper
- 100 pages
- Sewn binding
- Carta bianca 100 g/m²
- 100 pagine
- Rilegatura a punto Singer
- Papier blanc 100 g/m²
- 100 pages
- Reliure par couture Singer

- Papel blanco de 100 g/m²
- 100 páginas
- Encuadernación con cosido Singer
- Weißes Papier 100 g/m²
- 100 Seiten
- Singer-Fadenheftung

SOLD X 3

LINED



FSC®
CERTIFIED PAPER

The mark of
responsible forestry

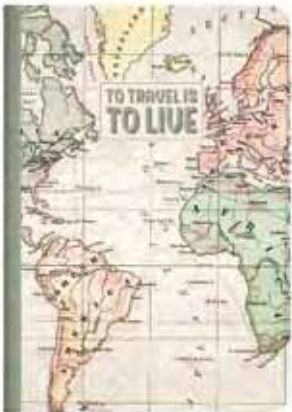

TRAVEL
BSNOT0013



8 051122 269808



STARS
BSNOT0023



8 052461 962238



MATH
BSNOT0024



8 052461 962245



JUNGLE
BSNOT0025



8 052461 962252



TOUCANS
BSNOT0026



8 052461 962269



FLAMINGO
BSNOT0027



8 052461 962276



CHERRY BOMB
BSNOT0028



8 052461 962283



PANDA
BSNOT0029



8 052461 962290

SPIRAL NOTEBOOKS

GOLD/SILVER
FOIL

LARGE SPIRAL NOTEBOOK

L 15.5 x H 21 cm

LINED NOTEBOOK

- 100 g/m² white paper
- 200 tear-off pages
- Elastic closure and back pocket

QUADERNO A RIGHE

- Carta bianca 100 g/m²
- 200 pagine staccabili
- Elastico di chiusura e taschina finale

CAHIER LIGNÉ

- Papier blanc 100 g/m²
- 200 pages détachables
- Fermeture élastique et pochette mémos

CUADERNO DE RAYAS

- Papel blanco de 100 g/m²
- 200 páginas separables
- Elástico de cierre y bolsillo final

LINIERTES HEFT

- Weißes Papier 100 g/m²
- 200 heraustrennbare Seiten
- Gummiband zum Verschließen und Einschubtasche hinten

LINED



FSC®
CERTIFIED PAPER

The mark of
responsible forestry



TRAVEL
A5NOTS0014



STARS
A5NOTS0015



MATH
A5NOTS0017



JUNGLE
A5NOTS0018



TOUCANS
A5NOTS0019



FLAMINGO
A5NOTS0020



CHEETAH
A5NOTS0021



CHERRY BOMB
A5NOTS0022



PUPPIES
A5NOTS0023



PANDA
A5NOTS0025



MAXI TRIO SPIRAL NOTEBOOK

L 22 x H 29,5 cm

3 IN 1 NOTEBOOK

- 100 g/m² white paper
- 204 tear-off pages: 68 lined, 68 squared, 68 dotted
- Elastic closure and back pocket

QUADERNO 3 IN 1

- Carta bianca 100 g/m²
- 204 pagine staccabili: 68 a righe, 68 a quadretti, 68 a puntini
- Elastico di chiusura e taschina finale

CAHIER 3 EN 1

- Papier blanc 100 g/m²
- 204 pages détachables: 68 lignées, 68 à carreaux, 68 à pointillés
- Fermeture élastique et pochette mémos

CUADERNO 3 EN 1

- Papel blanco de 100 g/m²
- 204 páginas separables: 68 de líneas, 68 de cuadros, 68 de puntos
- Elástico de cierre y bolsillo final

HEFT 3 IN 1

- Weißes Papier 100 g/m²
- 204 heraustrennbare Seiten: 68 liniert, 68 kariert, 68 punktkariert
- Gummiband zum Verschließen und Einschubtasche hinten

SOLD X 3

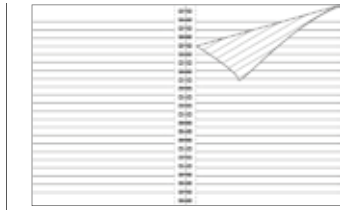

LINED



68 pages

SQUARED



68 pages

DOTTED



68 pages



FSC®
CERTIFIED PAPER

The mark of
responsible forestry



TRAVEL

A4NOTS0026



8 059174 834760



STARS

A4NOTS0027



8 059174 834777



JUNGLE

A4NOTS0028



8 059174 834784



PANDA

A4NOTS0029



8 059174 834791



MATH

A4NOTS0030



8 059174 835101



TOUCANS

A4NOTS0031



8 059174 835118



FLAMINGO

A4NOTS0032



8 059174 835125



CHEETAH

A4NOTS0033



8 059174 835132



CHERRY BOMB

A4NOTS0034



8 059174 835149



PUPPIES

A4NOTS0035



8 059174 835156

MINI SPIRAL NOTEBOOK

L 7 x H 10 cm

LINED NOTEBOOK

- 80 g/m² white paper
- 220 pages

QUADERNO A RIGHE

- Carta bianca 80 g/m²
- 220 pagine

CAHIER LIGNÉ

- Papier blanc 80 g/m²
- 220 pages

CUADERNO DE RAYAS

- Papel blanco de 80 g/m²
- 220 páginas

LINIERTES HEFT

- Weißes Papier 80 g/m²
- 220 Seiten



The mark of
responsible forestry

FSC®
CERTIFIED PAPER

LINED



* While stock lasts

SOLD X 3

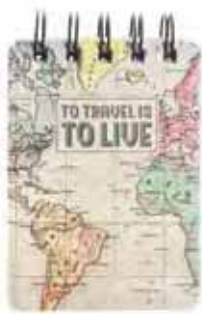

TRAVEL
MNOTS0002



8 058093 949241



BE WISE
MNOTS0004 *



8 058093 949265



FLOWERS BE HAPPY
MNOTS0006 *



8 058093 949289



STARS
MNOTS0011



8 051739 307733



BIKE LOVER
MNOTS0012



8 051739 307740



MATH
MNOTS0013



8 051739 307757



JUNGLE
MNOTS0014



8 051739 307764



TOUCANS
MNOTS0015



8 051739 307771



FLAMINGO
MNOTS0016



8 051739 307788



CHERRY BOMB
MNOTS0017



8 051739 307795



PANDA
MNOTS0019



8 051739 307818

PHOTO NOTEBOOKS

TECHNICAL DETAILS

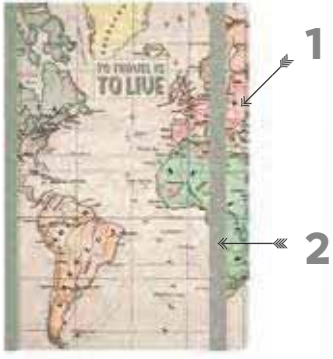

1 Single cellophane packaging
Cellophanatura singola
Emballage sous cellophane individuel
Envoltura individual en celofán
Einzelne Zellophanverpackung

3 Rounded corners
Angoli arrotondati
Angles arrondis
Esquinas redondeadas
Abgerundete Ecken

2 Elastic closure
Elastico di chiusura
Fermeture élastique
Elástico de cierre
Gummiband zum Verschließen

4 Last pages tear-off
Ultime pagine staccabili
Dernières pages détachables
Páginas finales separables
Letzte Seiten heraustrennbar

5 Back pocket
Taschina finale
Pochette mémos
Bolsillo final
Einschubtasche hinten

SIZES

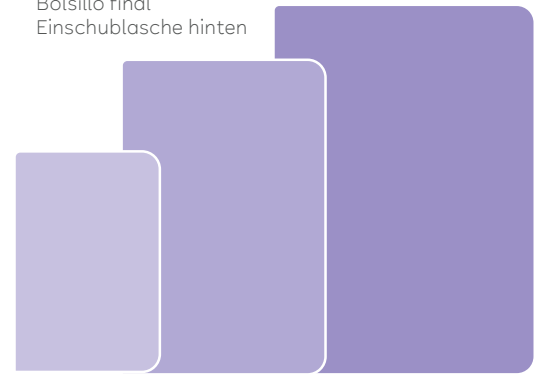

SMALL
9.5 x 13.5 cm

MEDIUM
12.5 x 18 cm

LARGE
17 x 24 cm



FSC®
CERTIFIED PAPER

The mark of
responsible forestry

SMALL PHOTO NOTEBOOK

L 9.5 x H 13.5 cm

LINED NOTEBOOK

- 120 g/m² paper
- 168 pages, back pocket, last 24 pages tear-off

TACCUINO A RIGHE

- Carta 120 g/m²
- 168 pagine, taschina finale, ultime 24 pagine staccabili

CARNET LIGNÉ

- Papier 120 g/m²
- 168 pages, pochette mémos, 24 dernières pages détachables

SOLD X 2

CUADERNO DE RAYAS

- Papel de 120 g/m²
- 168 páginas, bolsillo final, últimas 24 páginas separables

LINIERTES NOTIZBUCH

- Papier 120 g/m²
- 168 Seiten, Einschubtasche hinten, 24 heraustrennbare Seiten



GOLD/SILVER
FOIL

LINED

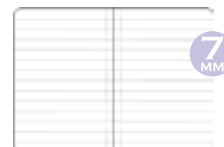

RAINBOW
NOTP0024



8 055748 242498



TRAVEL
NOTP0036



8 058093 946097



DREAM BIG
NOTP0037



8 058093 946103



BE WISE
NOTP0038



8 058093 946110



BE LUCKY
NOTP0039



8 058093 946127



KITTEN
NOTP0040



8 058093 946134



FLOWERS BE HAPPY
NOTP0041



8 058093 946141



HAPPINESS
NOTP0042



8 058093 946158



PANDA
NOTP0043



8 058093 946165



BE A STAR
NOTP0044



8 058093 946172



BE SMART
NOTP0045



8 058093 946189



SIX DONUTS
NOTP0046



8 058093 946196



BOOKLOVER
NOTP0048



8 058093 946219



STARS
NOTP0072



8 051739 308235



BIKE LOVER
NOTP0073



8 051739 308242



MATH
NOTP0074



8 051739 308259



JUNGLE
NOTP0075



8 051739 308266



TOUCANS
NOTP0076



8 051739 308273



FLAMINGO
NOTP0077



8 051739 308280



CHERRY BOMB
NOTP0078



8 051739 308297



PANDA
NOTP0080



8 051739 308310

MEDIUM PHOTO NOTEBOOK

L 12,5 x H 18 cm

LINED NOTEBOOK

- 120 g/m² paper
- 164 pages, back pocket, last 24 pages tear-off

TACCUINO A RIGHE

- Carta 120 g/m²
- 164 pagine, taschina finale, ultime 24 pagine staccabili

CARNET LIGNÉ

- Papier 120 g/m²
- 164 pages, pochette mémos, 24 dernières pages détachables

CUADERNO DE RAYAS

- Papel de 120 g/m²
- 164 páginas, bolsillo final, últimas 24 páginas separables

LINIERTES NOTIZBUCH

- Papier 120 g/m²
- 164 Seiten, Einschubtasche hinten, 24 heraustrennbare Seiten



LINED

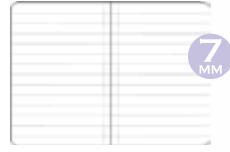

TECHNICAL DETAILS ON PAGE 212

* While stock lasts

SOLD X 2



TRAVEL
NOTP0049



8 058093 946226



BE WISE
NOTP0053



8 058093 946264



BE LUCKY
NOTP0054 *



8 058093 946271



SIX DONUTS
NOTP0061



8 058093 946349



STARS
NOTP0081



8 051739 308327



BIKE LOVER
NOTP0082



8 051739 308334



MATH
NOTP0083



8 051739 308341



JUNGLE
NOTP0084



8 051739 308358



TOUCANS
NOTP0085



8 051739 308365



FLAMINGO
NOTP0086



8 051739 308372



CHERRY BOMB
NOTP0087



8 051739 308389



PANDA
NOTP0089



8 051739 308402

LARGE PHOTO NOTEBOOK

L 17 x H 24 cm

LINED NOTEBOOK

- 120 g/m² paper
- 160 pages, back pocket, last 24 pages tear-off

TACCUINO A RIGHE

- Carta 120 g/m²
- 160 pagine, taschina finale, ultime 24 pagine staccabili

CARNET LIGNÉ

- Papier 120 g/m²
- 160 pages, pochette mémos, 24 dernières pages détachables

SOLD X 2

CUADERNO DE RAYAS

- Papel de 120 g/m²
- 160 páginas, bolsillo final, últimas 24 páginas separables

LINIERTES NOTIZBUCH

- Papier 120 g/m²
- 160 Seiten, Einschubtasche hinten, 24 heraustrennbare Seiten



LINED

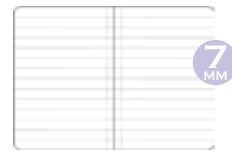

TECHNICAL DETAILS ON PAGE 212



TRAVEL
NOTP0064



8 058093 946370



BE WISE
NOTP0066



8 058093 946394



STARS
NOTP0090



8 051739 308419



MATH
NOTP0092



8 051739 308433



JUNGLE
NOTP0093



8 051739 308440



TOUCANS
NOTP0094



8 051739 308457



FLAMINGO
NOTP0095



8 051739 308464



CHERRY BOMB
NOTP0096



8 051739 308471



PANDA
NOTP0098



8 051739 308495

MY NOTEBOOK



NOTEBOOK

- 192 numbered pages
- Index
- Map to record your trips around the world
- Page for New Year's resolutions
- 12 pages with monthly planner
- Fun icons to mark the daily weather
- Contacts list
- Page to record IDs & passwords

TACCUINO

- 192 pagine numerate
- Indice
- Mappa per annotare i tuoi viaggi nel mondo
- Pagina per i propositi del nuovo anno
- 12 pagine con planner mensile
- Simpatiche icone per segnare il meteo del giorno
- Rubrica
- Pagina per annotare id & password

CARNET

- 192 pages numérotées
- Index
- Carte pour noter les voyages réalisés à travers le monde
- Page pour les bonnes résolutions du nouvel an
- 12 pages avec planner mensuel
- Images sympathiques pour marquer la météo du jour
- Répertoire
- Page pour noter identifiants et mots de passe

CUADERNO

- 192 páginas numeradas
- Índice
- Mapa para anotar tus viajes por el mundo
- Página para los propósitos de año nuevo
- 12 páginas con agenda mensual
- Simpatícos iconos para indicar el tiempo meteorológico de cada día
- Agenda de contactos
- Página para nombres de usuario y contraseñas

NOTIZBUCH

- 192 nummerierte Seiten
- Inhaltsverzeichnis
- Landkarte, um Ihre in der Welt gemachten Reisen zu verzeichnen
- Seite für die Vorsätze im neuen Jahr
- 12 Seiten mit Monatsplaner
- Sympathische Symbole zum Eintragen des Tageswetters
- Telefonverzeichnis
- Seite zum Notieren von IDs & Passwörtern

YEARLY GOALS



MY MAP



CONTACTS

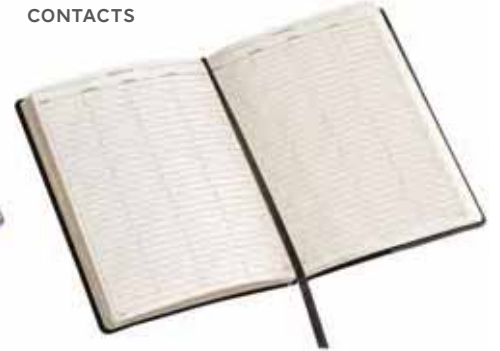

TECHNICAL DETAILS

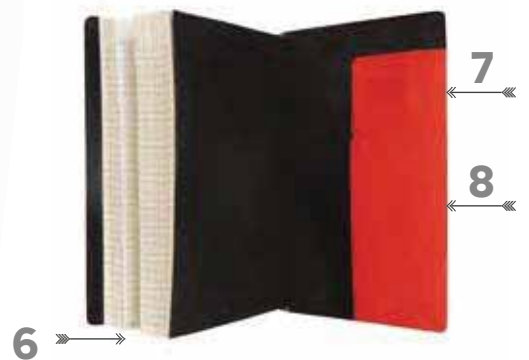
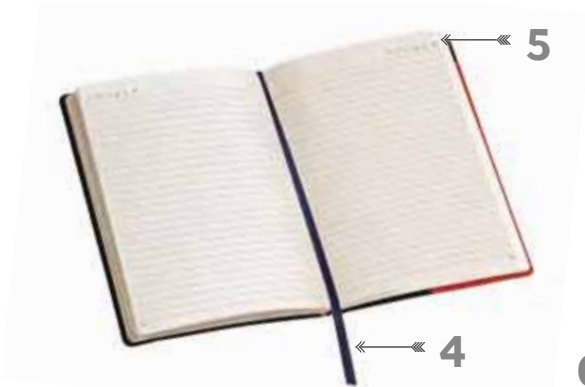
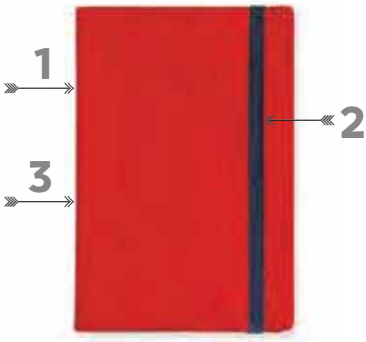

- 1 Cover made of soft PU
Copertina in morbido PU
Couverture en polyuréthane doux au toucher
Tapa en suave PU
Cover aus weichem PU
- 2 Elastic closure
Elastico di chiusura
Fermeture élastique
Elástico de cierre
Gummiband zum Verschließen
- 3 Single cellophane packaging
Cellophanatura singola
Emballage sous cellophane individuel
Envoltura individual en celofán
Einzelne Zellophanverpackung
- 4 Bookmark
Segnalibro
Marque-page
Marcapáginas
Lesezeichen-Band

- 5 Rounded corners
Angoli arrotondati
Angles arrondis
Esquinas redondeadas
Abgerundete Ecken
- 6 90 g/m² ivory paper
Carta avorio 90 g/m²
Papier ivoire 90 g/m²
Papel marfil 90 g/m²
Elfenbeinfarbenes Papier 90 g/m²
- 7 Pagemarker flap/pen holder
Patella segnapagina/portapenna
Rabat marque-page/porte-stylo
Lengüeta marcapáginas/
portabolígrafos
Lasche als Lesezeichen/Stifthalter
- 8 Back pocket
Taschina finale
Pochette mémos
Bolsillo final
Einschublasche hinten



FSC®
CERTIFIED PAPER

The mark of
responsible forestry

SIZES

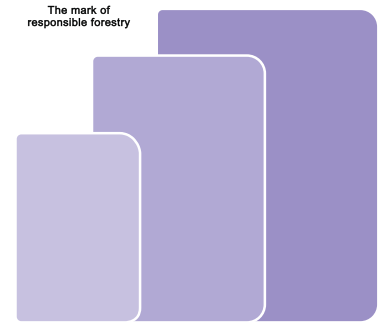

SMALL 9.5 x 13.5 cm
MEDIUM 12 x 18 cm
LARGE 17 x 24 cm

COLOUR CHART

Notebook



MY NOTEBOOK - DOTTED

FEATURES AND TECHNICAL DETAILS ON PAGE 216 EXCEPT:



Double bookmark
Doppio segnalibro
Double marque-page
Doble marcapáginas
Doppeltes Lesezeichen-Band



100 g/m² white paper
Carta bianca 100 g/m²
Papier blanc 100 g/m²
Papel blanco 100 g/m²
Weißes Papier 100 g/m²



Size: 13 x 21 cm
Formato: 13 x 21 cm
Format : 13 x 21 cm
Formato: 13 x 21 cm
Format: 13 x 21 cm

SOLD X 1



SMALL NOTEBOOK

L 9.5 x H 13.5 cm

* While stock lasts

SOLD X 1

LINED



6
MM

SQUARED



5
MM

PLAIN

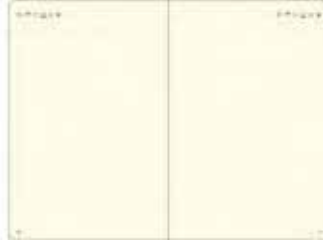

LINED



SQUARED



PLAIN



MEDIUM NOTEBOOK

L 12 x H 18 cm

SOLD X 1

* While stock lasts



LINED

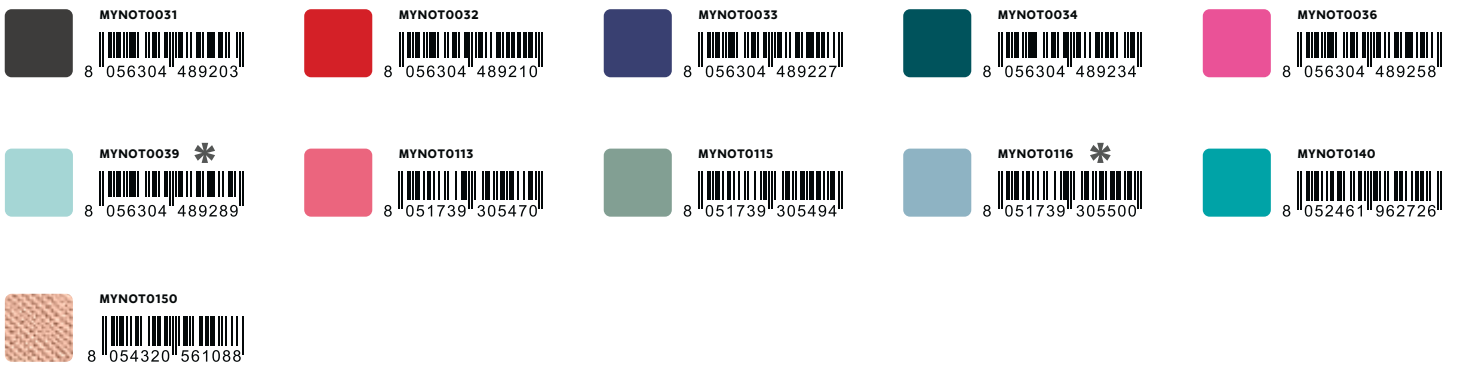

SQUARED



PLAIN



LARGE NOTEBOOK

L 17 x H 24 cm

* While stock lasts

SOLD X 1

LINED

SQUARED

PLAIN



LINED



SQUARED



PLAIN

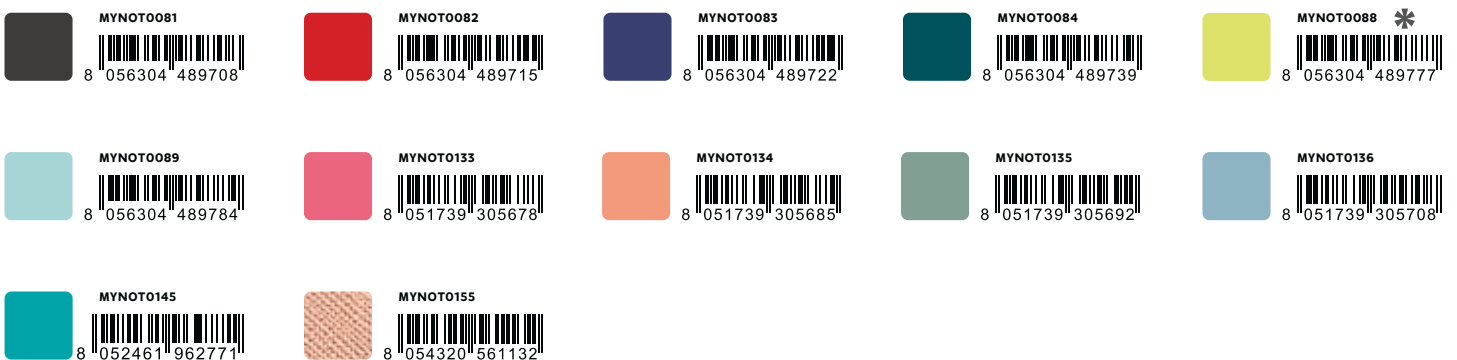

EMPTY DISPLAY ON DEMAND

material: acrylic and wood
L 47.5 x H 193 x W 47.5 cm
260 PCS - TOT. CAPACITY

DISNOTGREY



8 054320 564812

SMALL:
H 17.3 cm
80 pcs - 2 Sections

MEDIUM:
H 22.3 cm
120 pcs - 3 Sections

LARGE:
H 27.3 cm
60 pcs - 2 Sections



SMALL EMPTY DISPLAY ON DEMAND

material: cardboard
L 21 x H 10 x W 11 cm
10 PCS

DISNOTSM



8 051070 279096



NOTEBOOK COUNTER CARDBOARD DISPLAY

L 29.5 x H 28.5 x W 27 cm

DISDIAS



8 051739 305791

MEDIUM

DOTTED

SMALL



COLOURS COLLECTION

MINIMUM ORDER QUANTITY:
30 pcs (medium, dotted, small)

MEDIUM

SMALL

MINI
SPIRAL



PHOTO COLLECTION

MINIMUM ORDER QUANTITY:
30 pcs (medium, small, mini spiral)



NOTEBOOK FLOOR CARDBOARD DISPLAY (ON WOODEN BASE)

L 58.5 x H 158 x W 39 cm

DISDIAM



8 051739 305807

SMALL

SMALL

MEDIUM

MEDIUM

DOTTED

LARGE



COLOURS COLLECTION

MINIMUM ORDER QUANTITY:
• small: 60 pcs
• medium: 60 pcs
• dotted: 30 pcs
• large: 30 pcs

SMALL

MINI
SPIRAL

MEDIUM

LARGE
SPIRAL

LARGE

MAXI
SPIRAL



PHOTO COLLECTION

MINIMUM ORDER QUANTITY:
• small: 30 pcs
• mini spiral: 18 pcs
• medium: 30 pcs
• large spiral: 24 pcs
• large: 24 pcs
• maxi spiral: 21 pcs

Let's party
TOGETHER



GIFT BAGS

Let's party

TECHNICAL DETAILS

GIFT BAG

- Matte laminated paper 210 g/m², spot UV or coloured foil, ribbon handles

SACCHETTO REGALO

- Sacchetto in carta plastificata opaca 210 g/m², stampa con vernice UV o lamina, manici in nastro

SAC CADEAU

- Sac en papier plastifié opaque 210 g/m², dorure en couleur ou vernis UV, poignées ruban

* While stock lasts

SOLD X 3

BOLSA DE REGALO

- Bolsa de papel plastificado opaco 210 g/m², con barniz UV o plata serigrafiado, con asas de cinta de color

GESCHENKTÜTE

- Tüte aus mattem, mit Kunststoffolie überzogenem Papier 210 g/m², UV-Lack oder farbiger Folienprägung, Satin Handgriffe



The mark of responsible forestry

FSC® CERTIFIED PAPER



SMALL
L 10 cm
H 15 cm
W 6.5 cm

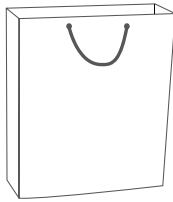

MEDIUM
L 19 cm
H 25 cm
W 11.5 cm

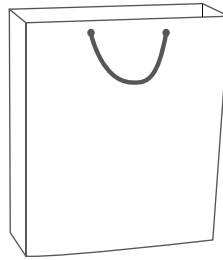

LARGE
L 26.5 cm
H 32.5 cm
W 11.5 cm

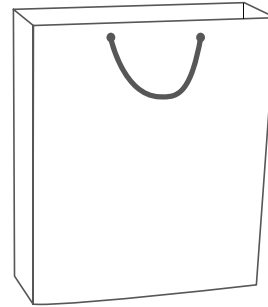

X-LARGE
L 31 cm | L 43 cm
H 43 cm | H 31 cm
W 11.5 cm | W 11.5 cm

VERTICAL HORIZONTAL

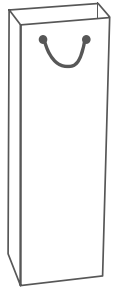

BOTTLE
L 12 cm
H 36 cm
W 8.5 cm

SMALL



GB0352



8 055748 242672



* GB0353



8 055748 242689



GB0355



8 055748 242702



GB0357



8 055748 242726



GB0473



8 056304 485960



GB0593



8 054320 563570





GB0361



8 055748 242764



GB0366



8 055748 242818



GB0371



8 055748 242863



✳ GB0373



8 055748 242887



GB0374



8 055748 242894



GB0376



8 055748 242917



GB0378



8 055748 242931



GB0479



8 056304 486028



GB0482



8 056304 486059



GB0484



8 056304 486073



✳ GB0505



8 052783 612859



✳ GB0506



8 052783 612866



GB0507



8 052783 612873



✳ GB0550



8 051739 306071



GB0585



8 054320 561439



GB0586



8 054320 561446



NEW

GB0587



NEW

GB0588



NEW

GB0589



NEW

GB0590



NEW

GB0591



NEW

GB0592



NEW

GB0616



NEW

GB0617



NEW

GB0618



NEW

GB0619



NEW

GB0620



NEW

GB0621



LARGE



GB0382



GB0384



GB0387



GB0389



GB0391



* GB0485



* GB0488



GB0489



* GB0508



* GB0510



* GB0511



GB0512



GB0513



* GB0551



NEW

GB0594



NEW

GB0595



NEW

GB0596



NEW

GB0597



NEW

GB0598



NEW

GB0599





NEW

GB0600



NEW

GB0601



NEW

GB0602



NEW

GB0603



NEW

GB0604



NEW

GB0605



NEW

GB0606



NEW

GB0607



X-LARGE



GB0399



* GB0400



* GB0494



* GB0514



GB0516



* GB0518





GB0608



GB0609



GB0610



GB0611



GB0612



GB0615



BOTTLE



GB0496



GB0497



GB0500



GB0613



GB0614





EMPTY DISPLAY ON DEMAND
 material: metal
 Ø 31.5 cm, H 150 cm
 minimum order qty: 99 pcs

DISGIF



WRAPPING PAPER

L 200 x H 70 cm

WRAPPING PAPER

- Weight: 80 g/m²
- Cardboard centre tube diameter 35 mm

CARTA REGALO

- Gramatura: 80 g/m²
- Anima in tubo rigido diametro 35 mm

PAPIER CADEAU

- Grammage: 80 g/m²
- Tube rigide central diamètre 35 mm

PAPEL DE REGALO

- Gramaje: 80 g/m²
- Tubo interior rígido - diámetro 35 mm

GESCHENKPAPIER

- Grammatu: 80 g/m²
- Stabiler Pappkern mit Durchmesser von 35 mm

* While stock lasts

INDIVIDUAL DESIGNS: SOLD X 3

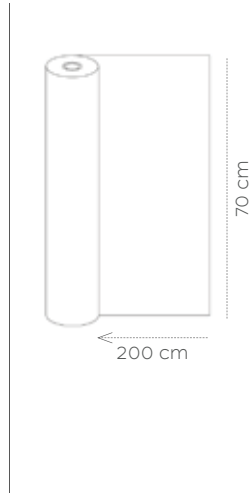

FIRST ORDER: MOQ 1 FULL ASSORTED DISPLAY (30 PCS)

material: cardboard
L 28 x H 70 x W 23 cm

30 PCS: 2 X WRAP0001, WRAP0002, WRAP0003, WRAP0009, WRAP0016, WRAP0017, WRAP0018, WRAP0019, WRAP0020, WRAP0021, WRAP0022, WRAP0023, WRAP0024, WRAP0025, WRAP0026

WRAPKITS



MAP
WRAP0001



STARS
WRAP0002



MUSICAL SCORE
WRAP0003



AFTER RAIN
WRAP0009



NAMASTÉ
WRAP0015 *



FLOWERS
WRAP0016



TROPICANA
WRAP0017



CHERRY
WRAP0018





CACTUS
WRAP0019



PANDA
WRAP0020



HEARTS
WRAP0021



SPACE
WRAP0022



BEAR
WRAP0023



UNICORN
WRAP0024



OMG
WRAP0025



HAPPY BIRTHDAY
WRAP0026



SMALL GREETING CARDS

L 7 x H 7 cm

SMALL GREETING CARDS

- Top-quality cards with coloured envelopes, all cards embossed and specially worked with coloured foils

BIGLIETTINI D'AUGURI

- Cartoncino avorio di altissima qualità, con busta colorata, tutti i soggetti con lavorazioni a rilievo e lamina colorata

CARTES DE VŒUX

- Cartes de vœux en carton de haute qualité, avec enveloppe en couleur, illustrations en relief avec feuilles en couleur

TARJETITAS

- Tarjetas de felicitación de cartulina de alta calidad con sobre colorado, todos los modelos en relieve con lamina colorada

SOLD X 10

MINIKARTEN

- Karten aus Papier von höher Qualität mit farbigem Umschlag, Reliefzeichnung mit farbigen Folien



The mark of responsible forestry

FSC® CERTIFIED PAPER



EMPTY DISPLAY ON DEMAND

material: cardboard
L 19 x H 35.5 x W 30 cm
minimum order qty: 240 pcs

DISCA2X6



BIRTHDAY



BQEB001



8 056304 487551



BQEB002



8 056304 487568



BQEB003



8 056304 487575



BQEB004



8 056304 487582



BQEB005



8 056304 487599



BQEB006



8 056304 487605



BQEB007



8 056304 487612



BQEB008



8 056304 487629



BQEB009



8 056304 487636



BQEB010



8 056304 487643



BQEB011



8 056304 487650



BQEB012



8 056304 487667



BQEB013



8 056304 487674



BQEB014



8 056304 487681



BQEB015



8 056304 487698



BQEB016



8 056304 487704



BQEB017



8 056304 487711

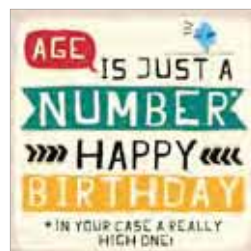

BQEB018



8 056304 487728



BQEB019



8 056304 487735



BQEB020



8 056304 487742



BQEB021



8 056304 487759



BQEB022



8 056304 487766



BQEB023



8 056304 487773



BQEB024



8 056304 487780



BQEB025



8 056304 487797



BQEB026



8 056304 487803

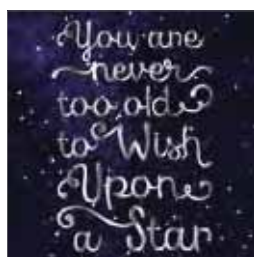

BQEB027



8 056304 487810



BQEB028



8 056304 487827



BQEB029



8 056304 487834



BQEB030



8 056304 487841

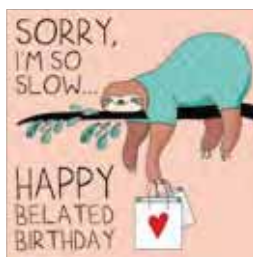

BQEB031



8 056304 487858



BQEB032



8 059174 833992



BQEB033



8 059174 834012



BQEB034



8 059174 834029



BQEL001



8 056304 487865

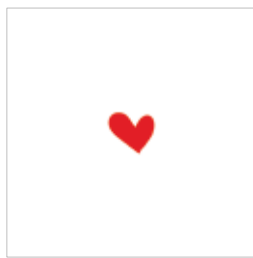

BQEL002



8 056304 487872



BQEL003



8 056304 487889



BQEL004



8 056304 487896



BQEL005



8 056304 487902



BQEL006



8 056304 487919



BQEL007



8 056304 487926



BQEL008



8 059174 834036



BQEL009



8 059174 834043

BABY BORN



BQEBB001



8 056304 487933



BQEBB002



8 056304 487940



BQEBB003



8 056304 487957



BQEBB004



8 056304 487964

VARIOUS



BQEV001



8 056304 487971



BQEV002



8 056304 487988



BQEV003



8 056304 487995



BQEV004



8 056304 488008



BQEV005



8 056304 488015

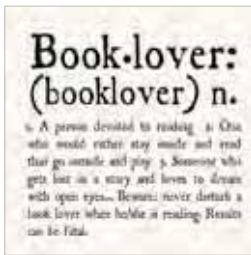

BQEV006



8 056304 488022



BQEV007



8 056304 488039



BQEV008



8 056304 488046



BQEV009



8 056304 488053



BQEV010



8 059174 834050



BQEV011



8 059174 834067

WEDDING



BQEW002



8 056304 488077

GRADUATION



BQEG001



8 056304 488084



BQEG002



8 059174 834074

FAMILY



BQEF001



8 056304 488091

L 11.5 x H 17 cm

GREETING CARDS

- Top-quality cards with coloured envelopes, all cards embossed and specially worked with coloured foils

BIGLIETTI D'AUGURI

- Biglietti in cartoncino di altissima qualità, con busta colorata, tutti i soggetti con lavorazioni a rilievo e lamina colorata

CARTES DE VŒUX

- Cartes de vœux en carton de haute qualité, avec enveloppe en couleur, illustrations en relief avec feuilles en couleur

SOLD X 5

TARJETAS DE FELICITACIÓN

- Tarjetas de felicitación de cartulina de alta calidad con sobre colorado, todos los modelos en relieve con lamina colorada

KARTEN

- Karten aus Papier von höher Qualität mit farbigem Umschlag, Reliefzeichnung mit farbigen Folien



The mark of responsible forestry



FSC®
CERTIFIED PAPER



BG0336



8 051070 279959



BG0337



8 051070 279966



BG0338



8 051070 279973



BG0339



8 051070 279980

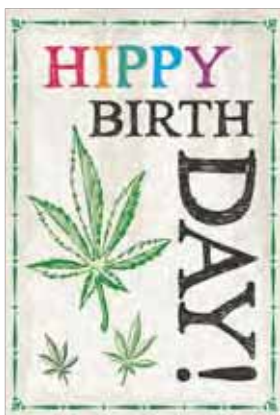

BG0340



8 051070 279997

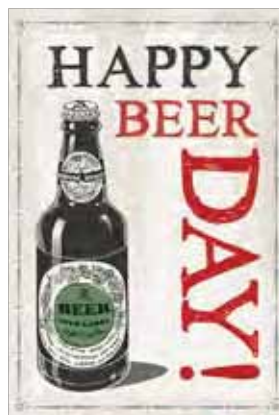

BG0341



8 057093 530015

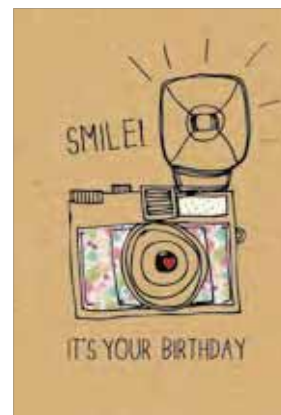

BG0342



8 057093 530022

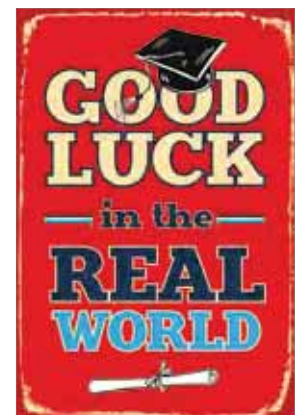

BG0343



8 057093 530039



BG0344



8 057093 530046

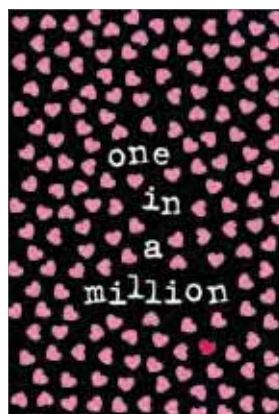

BG0345



8 057093 530053

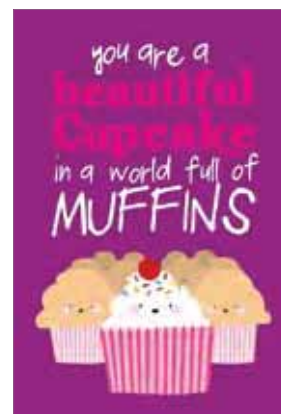

BG0346



8 057093 530060



BG0347



8 057093 530077



BG0348



8 057093 530084



BG0349



8 057093 530091

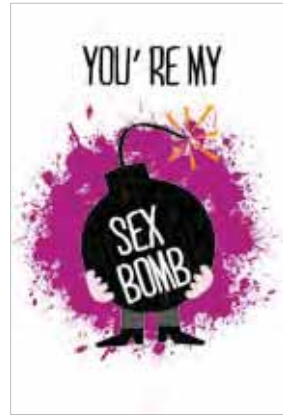

BG0350



8 057093 530107



BG0351



8 057093 530114



BG0363



8 057093 530251

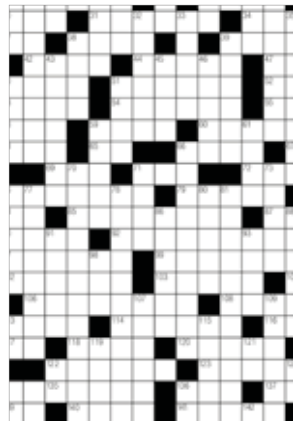

BG0401



8 051764 520510



BG0402



8 051764 520527



BG0403



8 051764 520534

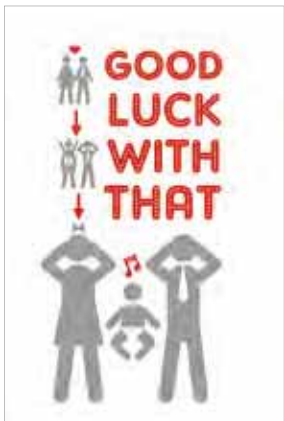

BG0404



8 051764 520541



BG0405



8 051764 520558



BG0636



8 055748 243501



BG0637



8 055748 243518



BG0651



8 056304 484123

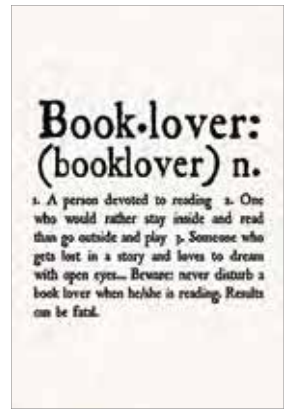

BG0652



8 056304 484130



BG0670



8 056304 488367



BG0671



8 056304 488374



BG0672



8 056304 488381



BG0673



8 056304 488398



BG0674



8 056304 488404



BG0676



8 056304 488428

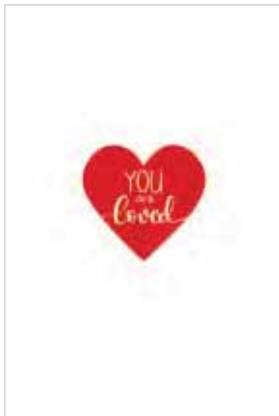

BG0677



8 056304 488435

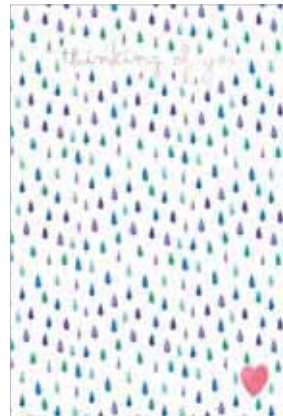

BG0678



8 056304 488442



BG0679



8 056304 488459



BG0680



8 056304 488466



BG0681



8 056304 488473



BG0682



8 056304 488480



BG0683



8 056304 488497

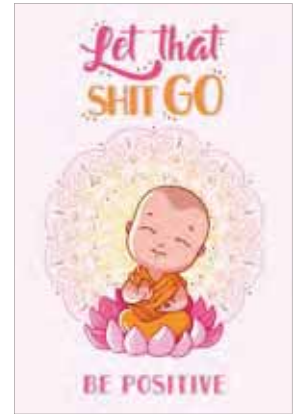

BG0700



8 051122 263905



BG0701



8 051122 263912



BG0702



8 051122 263929



BG0703



8 051122 263936

PARTY

3D GREETING CARDS

- Top-quality cards 350 g/m², with a coloured paper envelope
- All cards with coloured foil

BIGLIETTI D'AUGURI 3D

- Biglietti d'auguri in cartoncino di altissima qualità 350 g/m² con busta colorata
- Tutti i soggetti con lavorazioni in lamina colorata

CARTES DE VŒUX 3D

- Cartes de vœux en carton de haute qualité 350 g/m², avec enveloppe en papier coloré
- Tous les modèles avec dorure

TARJETAS DE FELICITACIÓN 3D

- Tarjetas de felicitación en papel de alta calidad, 350 g/m², con sobre de papel de color
- Todos los modelos finemente decorados

SOLD X 5

3D-GLÜCKWUNSCHKARTEN

- Glückwunschkarten aus Papier von hoher Qualität 350 g/m², mit Umschlag aus buntem Papier
- Alle Karten mit Folienprägung

PACKAGING

biobased cello bag
L 12 x H 18 cm



front



back



The mark of responsible forestry



FSC®
CERTIFIED PAPER



BG0643



8 056304 484048



BG0644



8 056304 484055



BG0645



8 056304 484062



BG0646



8 056304 484079



BG0647



8 056304 484086



BG0648



8 056304 484093

CHEERS

Let's party

GREETING CARDS

- Top-quality cards with coloured envelopes, all cards embossed and specially worked with coloured foils

BIGLIETTI D'AUGURI

- Biglietti in cartoncino di altissima qualità, con busta colorata, tutti i soggetti con lavorazioni a rilievo e lamina colorata

CARTES DE VŒUX

- Cartes de vœux en carton de haute qualité, avec enveloppe en couleur, illustrations en relief avec feuilles en couleur

TARJETAS DE FELICITACIÓN

- Tarjetas de felicitación de cartulina de alta calidad con sobre colorado, todos los modelos en relieve con lamina colorada

KARTEN

- Karten aus Papier von höher Qualität mit farbigem Umschlag, Reliefzeichnung mit farbigen Folien



FSC®
CERTIFIED PAPER



SOLD X 5

L 12.8 x H 12.8 cm (envelope size)



BG0653



8 056304 488190



BG0654



8 056304 488206



BG0655



8 056304 488213



BG0656



8 056304 488220

L 12 x H 19 cm (envelope size)



BG0657



8 056304 488237



BG0659



8 056304 488251



BG0660



8 056304 488268



BG0661



8 056304 488275

L 11.5 x H 17 cm (envelope size)



BG0658



8 056304 488244



BG0662



8 056304 488282

LOVELY

L 11.5 x H 17 cm

GREETING CARDS

- Top-quality cards with coloured envelopes, all cards embossed and specially worked with coloured foils

BIGLIETTI D'AUGURI

- Biglietti in cartoncino di altissima qualità, con busta colorata, tutti i soggetti con lavorazioni a rilievo e lamina colorata

CARTES DE VŒUX

- Cartes de vœux en carton de haute qualité, avec enveloppe en couleur, illustrations en relief avec feuilles en couleur

SOLD X 5

TARJETAS DE FELICITACIÓN

- Tarjetas de felicitación de cartulina de alta calidad con sobre colorado, todos los modelos en relieve con lamina colorada

KARTEN

- Karten aus Papier von höher Qualität mit farbigem Umschlag, Reliefzeichnung mit farbigen Folien



The mark of responsible forestry



FSC®
CERTIFIED PAPER



BG0624



8 057093 539513



BG0625



8 051764 521531



BG0626



8 051764 521548



BG0627



8 051764 521555



BG0628



8 051764 521562



BG0629



8 051764 521579



BG0634



8 055748 241910



BG0696



8 056304 488626



BG0697



8 056304 488633



BG0698



8 056304 488640



BG0699



8 056304 488657

L 11.5 x H 17 cm

GREETING CARDS

- Top-quality cards with coloured envelopes, all cards embossed and specially worked with coloured foils

BIGLIETTI D'AUGURI

- Biglietti in cartoncino di altissima qualità, con busta colorata, tutti i soggetti con lavorazioni a rilievo e lamina colorata

CARTES DE VŒUX

- Cartes de vœux en carton de haute qualité, avec enveloppe en couleur, illustrations en relief avec feuilles en couleur

TARJETAS DE FELICITACIÓN

- Tarjetas de felicitación de cartulina de alta calidad con sobre colorado, todos los modelos en relieve con lamina colorada

KARTEN

- Karten aus Papier von höher Qualität mit farbigem Umschlag, Reliefzeichnung mit farbigen Folien



The mark of responsible forestry



FSC®
CERTIFIED PAPER

SOLD X 5



BG0748



8 059174 833473



BG0749



8 059174 833480



BG0750



8 059174 833497



BG0751



8 059174 833503



BG0752



8 059174 833510



BG0753



8 059174 833527



BG0754



8 059174 833534



BG0755



8 059174 833541



BG0756



8 059174 833558



BG0757



8 059174 833565

LITTLE GIRLS

L 11.5 x H 17 cm

GREETING CARDS

- Top-quality cards with coloured envelopes, all cards embossed and specially worked with coloured foils

BIGLIETTI D'AUGURI

- Biglietti in cartoncino di altissima qualità, con busta colorata, tutti i soggetti con lavorazioni a rilievo e lamina colorata

CARTES DE VŒUX

- Cartes de vœux en carton de haute qualité, avec enveloppe en couleur, illustrations en relief avec feuilles en couleur

SOLD X 5

TARJETAS DE FELICITACIÓN

- Tarjetas de felicitación de cartulina de alta calidad con sobre colorado, todos los modelos en relieve con lamina colorada

KARTEN

- Karten aus Papier von höher Qualität mit farbigem Umschlag, Reliefzeichnung mit farbigen Folien



The mark of responsible forestry



FSC®
CERTIFIED PAPER



BG0758



8 059174 833572



BG0759



8 059174 833589



BG0760



8 059174 833596



BG0761



8 059174 833602



BG07562



8 059174 833619



BG0763



8 059174 833626



BG0764



8 059174 833633



BG0765



8 059174 833640



BG0766



8 059174 833657



BG0767



8 059174 833664

LOVING LETTERING

Let's party

L 11.5 x H 17 cm

GREETING CARDS

- Top-quality cards with coloured envelopes, all cards embossed and specially worked with coloured foils

BIGLIETTI D'AUGURI

- Biglietti in cartoncino di altissima qualità, con busta colorata, tutti i soggetti con lavorazioni a rilievo e lamina colorata

CARTES DE VŒUX

- Cartes de vœux en carton de haute qualité, avec enveloppe en couleur, illustrations en relief avec feuilles en couleur

SOLD X 5

TARJETAS DE FELICITACIÓN

- Tarjetas de felicitación de cartulina de alta calidad con sobre colorado, todos los modelos en relieve con lamina colorada

KARTEN

- Karten aus Papier von höher Qualität mit farbigem Umschlag, Reliefzeichnung mit farbigen Folien



The mark of responsible forestry



FSC®
CERTIFIED PAPER



BG0712



BG0713



BG0714



BG0715



BG0716



BG0718



HAPPINESS

L 11.5 x H 17 cm

GREETING CARDS

- Top-quality cards with coloured envelopes, all cards embossed and specially worked with coloured foils

BIGLIETTI D'AUGURI

- Biglietti in cartoncino di altissima qualità, con busta colorata, tutti i soggetti con lavorazioni a rilievo e lamina colorata

CARTES DE VŒUX

- Cartes de vœux en carton de haute qualité, avec enveloppe en couleur, illustrations en relief avec feuilles en couleur

SOLD X 5

TARJETAS DE FELICITACIÓN

- Tarjetas de felicitación de cartulina de alta calidad con sobre colorado, todos los modelos en relieve con lamina colorada

KARTEN

- Karten aus Papier von höher Qualität mit farbigem Umschlag, Reliefzeichnung mit farbigen Folien



The mark of responsible forestry



FSC®
CERTIFIED PAPER



BG0684



8 056304 488503



BG0685



8 056304 488510



BG0686



8 056304 488527



BG0687



8 056304 488534



BG0688



8 056304 488541



BG0690



8 056304 488565



BG0691



8 056304 488572

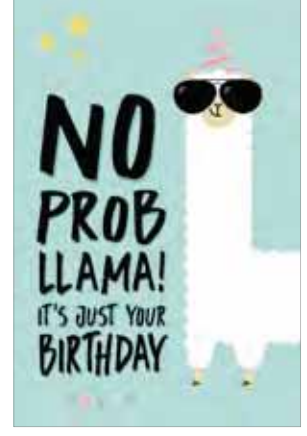

BG0692



8 056304 488589

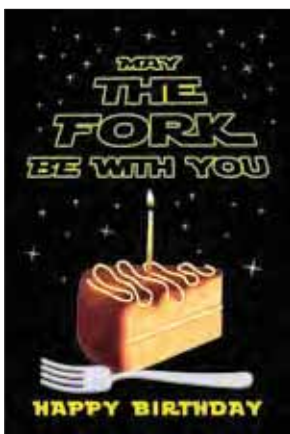

BG0693



8 056304 488596



BG0694



8 056304 488602



BG0695



8 056304 488619



BG0719



8 051739 309102

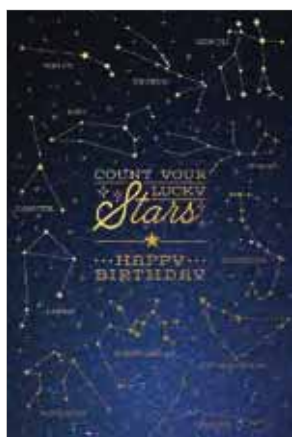

BG0720



8 051739 309119



BG0768



8 059174 833978

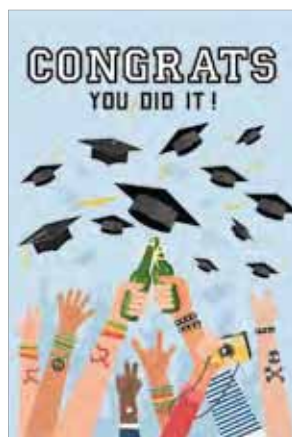

BG0769



8 059174 833855



BG0770



8 059174 833848

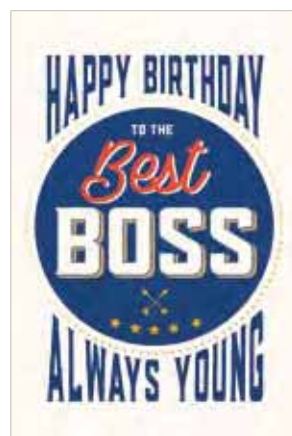

BG0771



8 059174 833862



BG0772



8 059174 833879



BG0773



8 059174 833886

DISPLAYS ON DEMAND



GREETING CARDS DISPLAY

- 12 pockets
- material: cardboard
- L 19 x H 35.5 x W 30 cm
- minimum order qty: 240 pcs

DISCA2X6



8 051070 279003

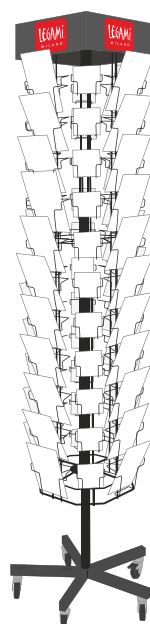

GREETING CARDS DISPLAY 44+44 CARDS

- Vertical stand with swivel wheels
- Loan for use free of charge
- Material: metal
- L 35 x H 180 x W 35 cm

MINIMUM ORDER QTY:

- 44 pockets for cards size 11.5x17 cm and 10.5x15.5 cm (10 pcs per pocket, total 440 pcs)
- 44 pockets for cards size 7x7 cm (10 pcs per pocket, total 440 pcs)

DISCAD44+44



8 052783 612996

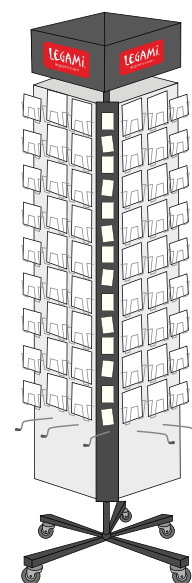

GREETING CARDS DISPLAY 72 CARDS

- Vertical stand with swivel wheels
- Loan for use free of charge
- Material: metal
- L 45 x H 183 x W 45 cm

MINIMUM ORDER QTY:

- 72 pockets for cards size 11.5x17 cm and 10.5x15.5 cm (10 pcs per pocket, total 720 pcs)
- 18 pockets for cards size 7x7 cm (10 pcs per pocket, total 180 pcs)
- 2 display magnet boards (total 72 pcs)
- 6 hooks for gift bags (12 pcs per hook, total 72 pcs)

DISCAD72



8 051070 278983

BIRTHDAY CALENDAR

L 11.5 x H 30.5 cm

BIRTHDAY CALENDAR

- Perpetual wall calendar with spiral binding
- 12 zodiac signs (1 per month)
- 14 sheets of 200 g/m² natural hammered paper

CALENDARIO DEI COMPLEANNI

- Calendario perpetuo da parete con rilegatura a spirale
- 12 segni zodiacali (1 per ogni mese)
- 14 fogli in carta 200 g/m² naturale martellata

CALENDRIER DES ANNIVERSAIRES

- Calendrier perpétuel mural avec reliure à spirale
- 12 signes astrologiques (1 par mois)
- 14 feuilles en papier 200 g/m² naturel martelé

CALENDARIO PARA CUMPLEAÑOS

- Calendario perpetuo de pared con espiral
- 12 signos zodiacales (1 para cada mes)
- 14 hojas de papel de 200 g/m² natural martillado

GEBURTSTAGSKALENDER

- Ewiger Wandkalender mit Spiralbindung
- 12 Sternzeichen (1 für jeden Monat)
- 14 Blätter aus natürlichem strukturiertem Papier 200 g/m²

SOLD X 3



The mark of responsible forestry

FSC®
CERTIFIED PAPER

BDC001



BALLOON MODELLING KIT

BALLOON MODELLING KIT

- Includes: 32 coloured balloons, 1 mini pump, 72 stick-on eyes, instructions
- Material: plastic, paper

KIT PALLONCINI MODELLABILI

- Include: 32 palloncini colorati, 1 pompetta, 72 occhi adesivi, istruzioni
- Materiale: plastica, carta

KIT BALLONS MODELABLES

- Il inclut : 32 ballons colorés, 1 petite pompe, 72 yeux adhésifs, le mode d'emploi
- Matériau : plastique, papier

KIT GLOBOS PARA MODELAR

- Incluye: 32 globos de colores, 1 mini inflador, 72 ojos adhesivos, instrucciones
- Material: plástico, papel

KIT MIT MODELLIERBAREN LUFTBALLONS

- Enthält: 32 farbige Luftballons, 1 kleine Pumpe, 72 Klebeaugen, Anweisungen
- Material: Kunststoff, Papier

PACKAGING
cardboard box
L 17 x H 10 x W 5 cm
SOLD X 4

BALLO001



PARTY KING & QUEEN

Ø 22 cm, H 19 cm (when inflated)

INFLATABLE CROWN

- Adult size
- Material: PVC

CORONA GONFIABILE

- Taglia adulta
- Materiale: PVC

COURONNE GONFLABLE

- Taille pour adultes
- Matériau : PVC

CORONA INFLABLE

- Talla de adulto
- Material: PVC

AUFBLASBARE KRONE

- Erwachsenengröße
- Material: PVC



PACKAGING
cardboard box
L 13 x H 18 x
W 3 cm



DISPLAY
material: cardboard
L 14 x H 31.5 x W 23 cm
7 PCS

CROKIT1



8 051128 751857



PACKAGING
cardboard box
L 13 x H 18 x
W 3 cm



DISPLAY
material: cardboard
L 14 x H 31.5 x W 23 cm
7 PCS

CROKIT2



8 051128 751864



PARTY PRINCE & PRINCESS

Ø 20 cm, H 16 cm (when inflated)

INFLATABLE CROWN

- Suitable for children between 3 and 10 years of age
- Material: PVC

CORONA GONFIABILE

- Adatta per bambini dai 3 ai 10 anni
- Materiale: PVC

COURONNE GONFLABLE

- Convient aux enfants de 3 à 10 ans
- Matériau : PVC

CORONA INFLABLE

- Adecuada para niños de 3 a 10 años
- Material: PVC

AUFBLASBARE KRONE

- Geeignet für Kinder von 3 bis 10 Jahren
- Material: PVC



PACKAGING
cardboard box
L 13 x H 18 x
W 3 cm



DISPLAY
material: cardboard
L 14 x H 31.5 x W 23 cm
7 PCS

CROKIT3



8 051128 751871



PACKAGING
cardboard box
L 13 x H 18 x
W 3 cm



DISPLAY
material: cardboard
L 14 x H 31.5 x W 23 cm
7 PCS

CROKIT4



8 051128 751888



CONFETTI POPPER

Ø 4.5 cm, H 18.5 cm

CONFETTI POPPER

- Coloured confetti
- Material: plastic and paper

SPARACORIANDOLI

- Coriandoli colorati
- Materiale: plastica e carta

LANCE CONFETTIS

- Confettis colorés
- Matériau : plastique et papier

LANZADOR DE CONFETI

- Confeti de colores
- Material: plástico y papel

KONFETTIWERFER

- Bunes Konfetti
- Material: Kunststoff und Papier

INDIVIDUAL DESIGNS: SOLD X 3



FIRST ORDER: MOQ 1 FULL ASSORTED DISPLAY (9 PCS)

material: cardboard
L 17 x H 26 x W 17 cm

9 PCS: 3 X COLOUR

CONFKIT1



8 056304 487384



Paper

CONF001



8 056304 487391

CONF002



8 056304 487407

CONF003



8 056304 487414

BOTTLE PARTY POPPER

Ø 4.5 cm, H 18.5 cm

BOTTLE PARTY POPPER

- Product contents under pressure
- Material: plastic and paper

BOTTIGLIA SPARACORIANDOLI

- Prodotto con contenuto sotto pressione
- Materiale: plastica e carta

BOUTEILLE CANON À CONFETTIS

- Produit au contenu sous pression
- Matériau : plastique et papier

BOTELLA LANZADORA DE CONFETI

- Producto con contenido a presión
- Material: plástico y papel

KONFETTIWERFER-FLASCHE

- Der Inhalt des Produkts steht unter Druck
- Material: Kunststoff und Papier



Paper

DISPLAY

material: cardboard
L 17 x H 26 x W 17 cm

9 PCS

MBCKIT1



8 051128 750126



MAXI BOTTLE PARTY POPPER

Ø 9.2 cm, H 33.5 cm

BOTTLE PARTY POPPER

- Product contents under pressure
- Material: plastic

BOTTIGLIA SPARACORIANDOLI

- Prodotto con contenuto sotto pressione
- Materiale: plastica

BOUTEILLE CANON À CONFETTIS

- Produit au contenu sous pression
- Matériau : plastique

BOTELLA LANZADORA DE CONFETI

- Producto con contenido a presión
- Material: plástico

KONFETTIWERFER-FLASCHE

- Der Inhalt des Produkts steht unter Druck
- Material: Kunststoff

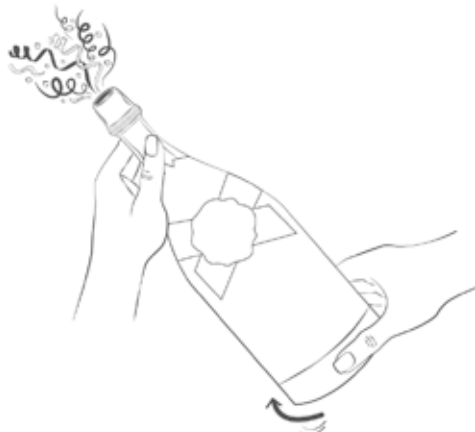

MBP0001



8 058093 949982

SOLD X 3



PARTY CANDLES WITH COLOURED FLAMES



Ø 0.5 cm, H 6 cm (plastic holder included)

PARTY CANDLES WITH COLOURED FLAME

- Plastic holders

CANDELINE CON FIAMMA COLORATA

- Supporti in plastica

BOUGIES DE FÊTE À FLAMME COLORÉE

- Supports en plastique

VELAS CON LLAMA DE COLORES

- Soportes de plástico

GEBURTSTAGSKERZEN MIT BUNTER FLAMME

- Kerzenstecker aus Kunststoff

PACKAGING
cardboard box
L 12 x H 13 x W 1 cm



DISPLAY
material: cardboard
L 13 x H 24 x W 19 cm
12 PCS

FLCKIT1



8 051128 755459



12 holders included

PARTY CANDLES

H 7 cm (plastic stand included)

CAKE CANDLES

- Plastic stands

CANDELINE PER TORTA

- Supporti in plastica

BOUGIES POUR GÂTEAU

- Supports en plastique

VELAS PARA TARTA

- Soportes de plástico

KERZEN FÜR TORTE

- Kerzenhalter aus Kunststoff

PACKAGING
PVC box w/hook
L 14.5 x H 11.5 x W 2.5 cm
SOLD X 6

HAP002



8 052783 614150



CAKE CANDLE

L 7 x H 7.5 x W 3 cm (plastic stand included)

CAKE CANDLE

- Plastic stand

CANDELINA PER TORTA

- Supporto in plastica

BOUGIE POUR GÂTEAU

- Support en plastique

VELA PARA TARTA

- Soporte de plástico

KERZE FÜR TORTE

- Kerzenhalter aus Kunststoff



PACKAGING

PET box w/hook
L 9.5 x H 11 x W 3 cm



DISPLAY

material: cardboard
L 10.5 x H 22.5 x W 19 cm

6 PCS

HAPKIT1



8 051128 752311



CAKE CANDELABRA

Ø 13.5 cm, H 14 cm (plastic stand included)

CAKE CANDELABRA

- 9 candles included
- Material: plastic

CANDELABRO PER TORTE

- 9 candeline incluse
- Materiale: plastica

CHANDELIER POUR GÂTEAUX

- Contient 9 bougies
- Matériau : plastique

CANDELABRO PARA TARTAS

- Contiene 9 velas
- Material: plástico

KERZENSTÄNDER FÜR TORTE

- Mit 9 Kerzen
- Material: Kunststoff

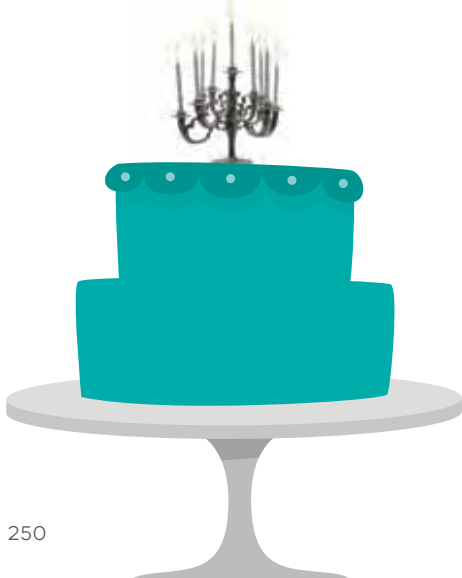

PACKAGING

window box
L 12.5 x H 11 x W 5 cm



DISPLAY

material: cardboard
L 26 x H 18.5 x W 10.5 cm

4 PCS

CANKIT1



8 051128 750133



MAXI CANDLES

L MAX 7.5 x H 15 x W 1.5 cm (plastic stand included)

MAXI CAKE CANDLE

- With glitter
- Plastic stand

MAXI CANDELA PER TORTA

- Con glitter
- Supporto in plastica

MAXI BOUGIE POUR GÂTEAU

- Avec paillettes
- Support en plastique

MAXI VELA PARA TARTA

- Con glitter
- Soporte de plástico

MAXI-KERZE FÜR TORTE

- Mit Glitter
- Kerzenhalter aus Kunststoff

PACKAGING

PVC box w/hook
L 11 x H 22 x W 2 cm

SOLD X 3



NUC0001



8 051739 308518



NUC0002



8 051739 308525



NUC0003



8 051739 308532



NUC0004



8 051739 308549



NUC0005



8 051739 308556



NUC0006



8 051739 308563



NUC0007



8 051739 308570



NUC0008



8 051739 308587



NUC0009



8 051739 308594



NUC0010



8 051739 308600



NUC0011



8 051739 308617



NUC0012



8 051739 308624



NUC0013



8 051739 308631



NUC0014



8 051739 308648



NUC0015



8 051739 308655



NUC0016



8 051739 308662



NUC0017



8 051739 308679



NUC0018



8 051739 308686



NUC0019



8 051739 308693



NUC0020



8 051739 308709

Pre-assorted displays

SMALL FLOOR SPINNER DISPLAY

- 4-sided, with shelves and hooks
- Swivel wheels
- Material: wood and iron, dust-repellent paint
- L 65 x H 171.5 x W 65 cm

DISPLAY + PRESELECTED SIDES:

STATIONERY COLLECTION
VINTAGE MEMORIES + LOL COLLECTION +
WONDERLAND COLLECTION



CHOOSE 2 SIDES FROM THE FOLLOWING*:

BEAUTY COLLECTION



HOME SWEET HOME +
LIGHTING



SOS COLLECTION



STATIONERY COLLECTION
(ADDITIONAL SIDE)



HI-TECH COLLECTION



TRAVEL COLLECTION +
BIKEAHOLIC COLLECTION



*You can't choose the same side twice



MEDIUM FLOOR DISPLAY

- 4-sided, with shelves and hooks
- Swivel wheels
- Material: wood and iron, dust-repellent paint
- L 100 x H 140 x W 80 cm

DISPLAY + PRESELECTED SIDES:

STATIONERY COLLECTION
(ONE SHELF SIDE + ½ SLAT SIDE)
HI-TECH COLLECTION
(SHELF SIDE)



CHOOSE 1 SHELF SIDE FROM THE FOLLOWING:

BEAUTY COLLECTION + MINI COLLECTION +
LUNCH BOX + HAND CLEANSING GEL



VINTAGE MEMORIES + LOL COLLECTION +
WONDERLAND COLLECTION



CHOOSE A ½ SLAT SIDE FROM THE FOLLOWING:

HOME SWEET HOME +
LIGHTING



SOS COLLECTION



TRAVEL COLLECTION +
BIKEAHOLIC COLLECTION



Displays on demand

Products not included

NOTEBOOK&DIARY FLOOR SPINNER DISPLAY

- 2 small sections
- 3 medium sections
- 2 large sections
- Material: acrylic and wood
- L 47.5 x H 193 x W 47.5 cm

DISNOTGREY



BAG DISPLAY

- Material: metal
- L 31.5 x H 150 x W 31.5 cm

DISGIF



FUNKY COLLECTION DISPLAY

- Material: metal
- L 22.5 x H 51 x W 33.5 cm

DISFUN



8 052783 613009



UMBRELLA DISPLAY

- Material: cardboard
- L 17 x H 24 x W 17 cm

DISUMB



8 051128 752502



MUSIC BOX DISPLAY

- Material: metal
- L 23 x H 42 x W 15 cm

DISSONG



8 052783 618097



BOOKMARK DISPLAY

- 14 hooks (hook capacity 12 pcs)
- Material: metal
- L 15 x H 45.5 x W 15 cm

DISWIRW



8 057093 532460



TRAVEL ORGANISER DISPLAY

- Material: cardboard
- L 15.5 x H 35 x W 22 cm

DISTO



8 055748 241996



PASSPORT HOLDER DISPLAY

- Material: cardboard
- L 15.5 x H 25.5 x W 17.5 cm

DISPH



8 055748 242016



BADGE HOLDER DISPLAY

- Material: cardboard
- L 13.5 x H 24.5 x W 23.5 cm

DISBH



8 055748 242009



CARD HOLDER DISPLAY

- Material: cardboard
- L 11 x H 23 x W 21 cm

DISCCH



8 055748 242023



MINI SECRET BOX MEDIUM DISPLAY

- Material: cardboard
- L 27.5 x H 19.5 x W 19 cm

DISMSBM



8 057093 530350



MINI SECRET BOX SMALL DISPLAY

- Material: cardboard
- L 27.5 x H 19 x W 19 cm

DISMSBS



8 051070 279140



NICE TO MEET YOU DISPLAY

- Material: cardboard
- L 16 x H 18 x W 15 cm

DISMCHM



8 052461 960470



SEE YOU SOON DISPLAY

- Material: cardboard
- L 26 x H 22.5 x W 12 cm

DISFGC



8 052461 965604



MY INITIAL KEY RING DISPLAY

- Material: cardboard
- L 27 x H 27.5 x W 19.5 cm

DISINK



8 052783 618103



LUCKY CHAIN DISPLAY

- Material: cardboard
- L 27 x H 27 x W 19.5 cm

DISLUCKY2



8 056304 488886



MAGNET DISPLAY

- Material: metal
- L 23.5 x H 30 x W 16 cm

DISMAG



8 051070 279232



WHAT A MASK! DISPLAY

- For adults and kids' masks
- Material: cardboard
- L 17.5 x H 27 x W 16.5 cm

DISMATE



8 051128 755600



ERASABLE PENS MEDIUM COUNTER DISPLAY

- 12 pockets
- material: acrylic
- L 23.5 x H 26 x W 17 cm
- minimum order qty: 300 pcs

DISEP



8 051128 755251



ERASABLE PEN REFILLS SMALL COUNTER DISPLAY

- 2 hooks
- material: cardboard
- L 13 x H 27 x W 10 cm
- minimum order qty: 50 pcs

DISREFEP



8 051128 755268



SIZE MATTERS DISPLAY

- Material: cardboard
- L 12.5 x H 18 x W 14.5 cm

DISMP



8 059174 834685



SMART TOUCH DISPLAY

- Material: cardboard
- L 12.5 x H 18 x W 14.5 cm

DISPWT



8 051739 305326



SMACK LIP BALM DISPLAY

- Material: cardboard
- L 19 x H 16.5 x W 10 cm

DISSMACK



8 051070 279201



PHONE CASE COUNTER SPINNER DISPLAY

- 10 hooks (hook capacity 5 pcs)
- Material: metal
- L 16.5 x H 49 x W 16.5 cm

DISCCL



8 051122 265503



GREETING CARDS COUNTER DISPLAY

- 12 pockets
- material: cardboard
- L 19 x H 35.5 x W 30 cm
- minimum order qty: 240 pcs

DISCA2X6



8 051070 279003



GREETING CARDS DISPLAY 44+44 CARDS

- Vertical stand with swivel wheels
- Loan for use free of charge
- Material: metal
- L 35 x H 180 x W 35 cm

MINIMUM ORDER QTY:

- 44 pockets for cards size 11.5x17 cm and 10.5x15.5 cm (10 pcs per pocket, total 440 pcs)
- 44 pockets for cards size 7x7 cm (10 pcs per pocket, total 440 pcs)

DISCAD44+44



8 052783 612996

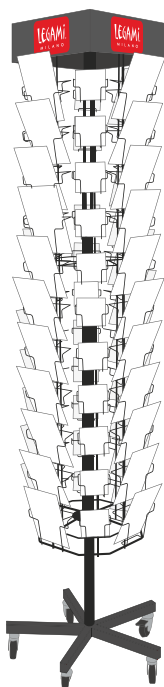

GREETING CARDS DISPLAY - 72 CARDS

- Vertical stand with swivel wheels
- Loan for use free of charge
- Material: metal
- L 45 x H 183 x W 45 cm

MINIMUM ORDER QTY:

- 72 pockets for cards size 11.5x17 cm and 10.5x15.5 cm (10 pcs per pocket, total 720 pcs)
- 18 pockets for cards size 7x7 cm (10 pcs per pocket, total 180 pcs)
- 2 display magnet boards (total 72 pcs)
- 6 hooks for gift bags (12 pcs per hook, total 72 pcs)

DISCAD72



8 051070 278983

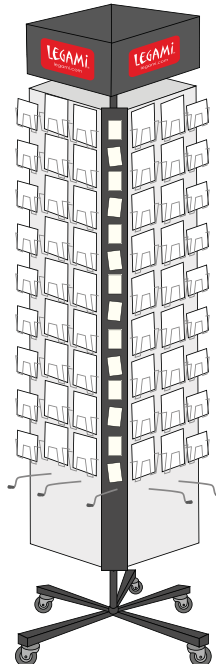

MUG DISPLAY

- 2-sided
- Material: cardboard, wooden base
- L 55 x H 162 x W 35 cm

MINIMUM ORDER QTY: 63 PCS

- Espresso for two: 18 pcs
- Cup-puccino / Count your lucky stars: 30 pcs
- Tu vuoi fà l'americano: 15 pcs

DISMUG2



8 054320 564973





NOTEBOOK COUNTER CARDBOARD DISPLAY

- Material: cardboard
- L 29.5 x H 28.5 x W 27 cm

DISDIAS



8 051739 305791

MEDIUM
DOTTED
SMALL



COLOURS COLLECTION

- MINIMUM ORDER QUANTITY:**
- 30 pcs (medium, dotted, small)

MEDIUM
SMALL
MINI SPIRAL



PHOTO COLLECTION

- MINIMUM ORDER QUANTITY:**
- 30 pcs (medium, small, mini spiral)



NOTEBOOK FLOOR CARDBOARD DISPLAY (ON WOODEN BASE)

- Material: cardboard, wooden base
- L 58.5 x H 158 x W 39 cm

DISDIAM



8 051739 305807

SMALL
SMALL
MEDIUM
MEDIUM
DOTTED
LARGE



COLOURS COLLECTION

- MINIMUM ORDER QUANTITY:**
- small: 60 pcs
 - medium: 60 pcs
 - dotted: 30 pcs
 - large: 30 pcs

SMALL
MINI SPIRAL
MEDIUM
LARGE SPIRAL
LARGE
MAXI SPIRAL



PHOTO COLLECTION

- MINIMUM ORDER QUANTITY:**
- small: 30 pcs
 - mini spiral: 18 pcs
 - medium: 30 pcs
 - large spiral: 24 pcs
 - large: 24 pcs
 - maxi spiral: 21 pcs



HOT&COLD VACUUM BOTTLE COUNTER DISPLAY

- Material: cardboard
- L 21 x H 26.5 x W 31 cm

MINIMUM ORDER QUANTITY:

- 16 pcs



DISBOTS



HOT&COLD VACUUM BOTTLE FLOOR CARDBOARD DISPLAY

- Material: cardboard, wooden base
- L 46 x H 176 x W 39 cm



MINIMUM ORDER QUANTITY:













- 32 pcs

DISBOTM

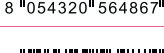
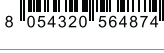

COLLECTION	ITEM	N° PCS X DESIGN / COLOUR	PAGE	EAN CODE
HOME SWEET HOME LIGHTING	MINI DECORATIVE LIGHTS RANGE	3 PCS X LETTER	18	8 054320 564386
HOME SWEET HOME LIGHTING	MINI DECORATIVE LIGHTS RANGE	3 PCS X SHAPE	19	8 054320 564379
HOME SWEET HOME LIGHTING	MINI DECORATIVE LIGHTS RANGE + DISPLAY	5 PCS X SHAPE 5 PCS X A, G, L, M, R, S 3 PCS X B, C, D, E, F, H, I, J, K, N, O, P, Q, T, U, V, W, X, Y, Z, &	19	8 054320 561255
TRAVEL COLLECTION	TRAVEL ORGANISER RANGE + DISPLAY	3 PCS X COLOUR	27	8 054320 564720
TRAVEL COLLECTION	PASSPORT HOLDER RANGE + DISPLAY	3 PCS X COLOUR	28	8 054320 564614
TRAVEL COLLECTION	BADGE HOLDER RANGE + DISPLAY	3 PCS X COLOUR	29	8 054320 564188
TRAVEL COLLECTION	CARD HOLDER RANGE + DISPLAY	3 PCS X COLOUR	30	8 054320 564249
TRAVEL COLLECTION	LUGGAGE TAG RANGE	3 PCS X COLOUR	30	8 054320 564348
BAGS & CO COLLECTION	WHAT A WALLET! RANGE	2 PCS X DESIGN	41	8 054320 564768
BAGS & CO COLLECTION	HOT & COLD BOTTLE 500 ml RANGE	2 PCS X DESIGN	42	8 054320 564980
BAGS & CO COLLECTION	HOT & COLD BOTTLE 800 ml RANGE	2 PCS X DESIGN	43	8 054320 564751
BAGS & CO COLLECTION	HOT & COLD RANGE + COUNTER DISPLAY	2 PCS X DESIGN	43	8 054320 564300
BAGS & CO COLLECTION	HOT & COLD RANGE + FLOOR DISPLAY	4 PCS X DESIGN	43	8 054320 564317
BAGS & CO COLLECTION	COIN PURSE RANGE	3 PCS X DESIGN	46	8 054320 564256
BAGS & CO COLLECTION	ZIPPER POUCH RANGE	3 PCS X DESIGN	47	8 054320 564744
BAGS & CO COLLECTION	EVERYDAY BAG RANGE	2 PCS X DESIGN	50	8 054320 564195
LIFESTYLE COLLECTION KEY RING	LUCKY CHAIN RANGE	3 PCS X DESIGN	59	8 054320 564331
LIFESTYLE COLLECTION MUGS	ESPRESSO FOR TWO RANGE	2 PCS X DESIGN	63	8 054320 564294
LIFESTYLE COLLECTION MUGS	COUNT YOUR LUCKY STARS RANGE	1 PC X DESIGN	64	8 054320 564270
LIFESTYLE COLLECTION MUGS	CUP-PUCCINO RANGE	1 PC X DESIGN	65	8 054320 564287
LIFESTYLE COLLECTION MUGS	TU VUÒ FÀ L'AMERICANO RANGE	1 PC X DESIGN	67	8 054320 564737
LIFESTYLE COLLECTION MAGNETS	SOMETHING TO REMEMBER RANGE	2 PCS X DESIGN	72	8 054320 564706
BEAUTY COLLECTION	SMACK - NATURAL LIP BALM RANGE	4 PCS X DESIGN	78	8 054320 564683
SOS COLLECTION	CAR SWEET CAR RANGE	12 PCS X DESIGN	87	8 054320 564232
HI-TECH COLLECTION	LINK UP RANGE	3 PCS X DESIGN	115	8 054320 564324
HI-TECH COLLECTION	SINGING IN THE SHOWER RANGE	2 PCS X DESIGN	116	8 054320 564676
HI-TECH COLLECTION	SUPER FAST RANGE	3 PCS X DESIGN	118	8 054320 564713
HI-TECH COLLECTION	MY SUPER POWER RANGE	2 PCS X DESIGN	120	8 054320 564638

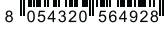
COLLECTION	ITEM	N° PCS X DESIGN / COLOUR	PAGE	EAN CODE
HI-TECH COLLECTION	MOUSEPAD RANGE	2 PCS X DESIGN	125	8 054320 564409
BIKEAHOLIC COLLECTION	BIKE HORN RANGE	2 PCS X DESIGN	136	8 054320 564218
BIKEAHOLIC COLLECTION	BIKE BELL RANGE	2 PCS X DESIGN	137	8 054320 564201
LOL COLLECTION	ANTI-STRESS FORMULA RANGE	2 PCS X DESIGN	139	8 054320 564171
VINTAGE MEMORIES	MUSIC BOX RANGE	5 PCS X DESIGN	153	8 054320 564416
STATIONERY COLLECTION	CLICK&CLACK RANGE DISPLAY	1 DISPLAY X DESIGN	165	8 054320 564775
STATIONERY COLLECTION	PENCIL CASE RANGE	3 PCS X DESIGN	177	8 054320 564539
STATIONERY COLLECTION	SMART NOTES RANGE	2 PCS X DESIGN	187	8 054320 564690
STATIONERY COLLECTION	PAPER THOUGHTS RANGE	3 PCS X DESIGN	187	8 054320 564607
STATIONERY COLLECTION	BOOKMARKS ZODIAC RANGE	3 PCS X DESIGN	193	8 054320 564225
NOTEBOOK COLLECTION	QUADERNO SMALL LINED RANGE	3 PCS X DESIGN	206	8 054320 564652
NOTEBOOK COLLECTION	QUADERNO MEDIUM LINED RANGE	3 PCS X DESIGN	207	8 054320 564645
NOTEBOOK COLLECTION	QUADERNO MEDIUM PLAIN RANGE	3 PCS X DESIGN	207	8 054320 564591
NOTEBOOK COLLECTION	QUADERNO LARGE LINED RANGE	3 PCS X DESIGN	208	8 054320 564669
NOTEBOOK COLLECTION	LARGE SPIRAL NOTEBOOK RANGE	3 PCS X DESIGN	209	8 054320 564584
NOTEBOOK COLLECTION	MAXI TRIO SPIRAL NOTEBOOK RANGE	3 PCS X DESIGN	210	8 054320 564355
NOTEBOOK COLLECTION	MINI SPIRAL NOTEBOOK RANGE	3 PCS X DESIGN	211	8 054320 564393
NOTEBOOK COLLECTION	SMALL PHOTO NOTEBOOK RANGE	2 PCS X DESIGN	212	8 054320 564560
NOTEBOOK COLLECTION	MEDIUM PHOTO NOTEBOOK RANGE	2 PCS X DESIGN	214	8 054320 564553
NOTEBOOK COLLECTION	LARGE PHOTO NOTEBOOK RANGE	2 PCS X DESIGN	215	8 054320 564546
NOTEBOOK COLLECTION	MY NOTEBOOK DOTTED RANGE	1 PC X COLOUR	217	8 054320 564430
NOTEBOOK COLLECTION	MY NOTEBOOK SMALL LINED RANGE	1 PC X COLOUR	218	8 054320 564508
NOTEBOOK COLLECTION	MY NOTEBOOK SMALL SQUARED RANGE	1 PC X COLOUR	218	8 054320 564522
NOTEBOOK COLLECTION	MY NOTEBOOK SMALL PLAIN RANGE	1 PC X COLOUR	218	8 054320 564515
NOTEBOOK COLLECTION	MY NOTEBOOK MEDIUM LINED RANGE	1 PC X COLOUR	219	8 054320 564478
NOTEBOOK COLLECTION	MY NOTEBOOK MEDIUM SQUARED RANGE	1 PC X COLOUR	219	8 054320 564492
NOTEBOOK COLLECTION	MY NOTEBOOK MEDIUM PLAIN RANGE	1 PC X COLOUR	219	8 054320 564485
NOTEBOOK COLLECTION	MY NOTEBOOK LARGE LINED RANGE	1 PC X COLOUR	220	8 054320 564447
NOTEBOOK COLLECTION	MY NOTEBOOK LARGE SQUARED RANGE	1 PC X COLOUR	220	8 054320 564461

COLLECTION	ITEM	N° PCS X DESIGN / COLOUR	PAGE	EAN CODE
NOTEBOOK COLLECTION	MY NOTEBOOK LARGE PLAIN RANGE	1 PC X COLOUR	220	
LET'S PARTY TOGETHER	MAXI CANDLES RANGE	3 PCS X DESIGN	251	
SMALL FLOOR SPINNER DISPLAY	SMALL FLOOR SPINNER DISPLAY + FIXED ASSORTMENT	PRE-ASSORTED PACK	252	
SMALL FLOOR SPINNER DISPLAY	BEAUTY COLLECTION ASSORTMENT SMALL FLOOR SPINNER DISPLAY	PRE-ASSORTED PACK	252	
SMALL FLOOR SPINNER DISPLAY	HOME SWEET HOME + LIGHTING ASSORTMENT SMALL FLOOR SPINNER DISPLAY	PRE-ASSORTED PACK	252	
SMALL FLOOR SPINNER DISPLAY	SOS COLLECTION ASSORTMENT SMALL FLOOR SPINNER DISPLAY	PRE-ASSORTED PACK	252	
SMALL FLOOR SPINNER DISPLAY	STATIONERY COLLECTION ADDITIONAL ASSORTMENT SMALL FLOOR SPINNER DISPLAY	PRE-ASSORTED PACK	252	
SMALL FLOOR SPINNER DISPLAY	HI-TECH COLLECTION ASSORTMENT SMALL FLOOR SPINNER DISPLAY	PRE-ASSORTED PACK	252	
SMALL FLOOR SPINNER DISPLAY	TRAVEL COLLECTION + BIKEAHOLIC ASSORTMENT SMALL FLOOR SPINNER DISPLAY	PRE-ASSORTED PACK	252	
MEDIUM FLOOR DISPLAY	MEDIUM FLOOR DISPLAY + FIXED ASSORTMENT	PRE-ASSORTED PACK	252	
MEDIUM FLOOR DISPLAY	BEAUTY COLLECTION + MINI COLLECTION + LUNCH BOX ASSORTMENT MEDIUM FLOOR DISPLAY	PRE-ASSORTED PACK	252	
MEDIUM FLOOR DISPLAY	VINTAGE + WONDERLAND + LOL ASSORTMENT MEDIUM FLOOR DISPLAY	PRE-ASSORTED PACK	252	
MEDIUM FLOOR DISPLAY	HOME SWEET HOME + LIGHTING ASSORTMENT MEDIUM FLOOR DISPLAY	PRE-ASSORTED PACK	252	
MEDIUM FLOOR DISPLAY	SOS COLLECTION ASSORTMENT MEDIUM FLOOR DISPLAY	PRE-ASSORTED PACK	252	
MEDIUM FLOOR DISPLAY	TRAVEL COLLECTION + BIKEAHOLIC ASSORTMENT MEDIUM FLOOR DISPLAY	PRE-ASSORTED PACK	252	

CONTACTS

HEAD OFFICE

LEGAMI SRL

18, via Stezzano
24052 Azzano San Paolo (Bg), Italy
T. +39 035 534168
info@legami.com

DIRECTOR OF SALES

Francesco Arcidiacono
T. +39 035 534168
M. +39 347 8990546
francesco.arcidiacono@legami.com

AREA MANAGER - ITALY

Enrico Fassi
T. +39 035 534168
M. +39 347 4131204
enrico.fassi@legami.com

AREA MANAGER - EXPORT (UK, IRELAND, THE NETHERLANDS, NORTH EUROPE, USA, CANADA, AUSTRALIA)

Igor Salmi
T. +39 035 534168
M. +39 349 5183603
igor.salmi@legami.com

AREA MANAGER - EXPORT (GERMANY, AUSTRIA, SWITZERLAND, EAST EUROPE)

Christian Termeer
T. +39 035 534168
M. +39 392 3902982
christian.termeer@legami.com

COUNTRY MANAGERS

AUSTRIA & SOUTH GERMANY

Jerzy Ziolkowski
M. +49 175 5637915
fhz.ziolkowski@gmail.com

NORTH GERMANY

Raimund Epping
M. +49 171 7779066
raimund.epping@t-online.de

EAST GERMANY

Stefan Wecker
M. +49 160 94452331
post@stefanwecker.de

BELGIUM & LUXEMBOURG

Artolis Lux sarl
Tristan van Overbroek
M. +32 475 395413
t.overbroek@artolislux.com

FRANCE

Yellow Diffusion
Maud Dreuillat
M. +33 6 02237364
maud.dreuillat@legami.com

Charlotte Morvan
M. +33 6 66528805
charlotte.morvan@yellowdiffusion.com

NORTHERN IRELAND

Isla Agencies Ltd
Paul Jackson
M. +44 788 0682645
pjac794518@aol.com

IRELAND

Isla Agencies Ltd
Jackie Rabbitte
M. +353 878 563580
jackierabbitte@gmail.com

PORTUGAL

Estrelas de Papel
Rogério Moreira
M. +351 213 511080
rogerio.moreira@estrelasdepapel.pt
www.estrelasdepapel.pt

SPAIN

Som2
Santi Pares
M. +34 660 873515
santipares@somdos.com

Christophe Martin
M. +34 609 480757
chmartin@somdos.com

THE NETHERLANDS

Interesting Sales
Peter Verboom
T. +31 355263577
M. +31 611445007
info@interestingsales.nl

GREAT BRITAIN & CHANNEL ISLANDS

Pen Paper Gift Ltd
Michael Owen
M. +44 7739 281451
michael@penpapergift.co.uk

DISTRIBUTORS

AUSTRALIA & NEW ZEALAND

The Paperie
Martin Burton
T. +61 417 668898
martin@thepaperie.com.au
www.thepaperie.com.au

CANADA

Jannex Enterprises 1980 LTD
Adam Hes
T. +1 905 2848484
Fax. +1 905 2848485
adamh@jannex.com
www.jannex.com

CENTRAL AMERICA

Desarrollos Culturales Costarricenses D.C.C, S.A.
Sales Department
T. +506 2220 3015
info@dcc.cr
www.dcc.cr

CYPRUS

Mohel Ltd
T. +357 99434562
info@kontossi1935.gr

CROATIA

Soho
Robert Komazec
T. +385 1 3648717
M. +385 98 417854
robert@soho.hr
www.soho.hr

DENMARK

Kidek AB
Sales Department
T. +46 42 165520
info@kidek.dk
www.kidek.dk

GCC (GULF COUNTRIES)

SGCO Trading FZE
Serge Dfouni
T. +971 56 4433292
serge@sgco.me
www.sgco.me

GREECE

Panos Voyatzis Sa
Panos Voyatzis
M. +30 210 3247 128
pv@fiftyfifty.gr

LEBANON

S&G Group
Jowelle Dfouni
T. +961 1 332062
info@sgco.me
www.sgco.me

MEXICO

Casa Greha SA de CV
Sandra Gresati
T. +52 33 1374 0316
hola@grupogreha.com
www.grupogreha.com

NORWAY

Handysize Nordic AS
Sales Department
T. +47 21525242
ordre@handysizenordic.no
www.handysizenordic.no

PRC - SHANGHAI OFFICE

Doris Zhang 章晓敏
T. +86 21 60 15 10 62
M. +86 138 17 99 07 47
zhang.doris@yzshanghai.cn

Raul Thomas Mora 托马斯
T. +86 21 60 15 10 62
M. +86 137 61 61 61 62
raul.mora@yzshanghai.cn

ROMANIA

Alma Artex SRL
Adrian Harhoi
T. +40 212 117741
adrian.harhoi@alma.ro
www.alma.ro

SLOVENIA

Acron d.o.o.
Martin Lampret
T. +386 1 620 96 28
martin@acron-trgovina.si
www.officeandmore.si

SOUTH AFRICA

SG Distributors
Giulietta Campanelli
T. +27 11 4449050
giulietta@sgdistributors.co.za
www.sgdistributors.co.za

SWEDEN (AND THE ÅLAND ISLANDS)

Kidek AB
Sales Department
T. +46 42 165520
info@kidek.se
www.kidek.se

SWITZERLAND

Edizioni Alfa Kartos SA
Marco Danzi
T. +41 91 7916783
info@alfa-kartos.ch
www.alfa-kartos.ch

TURKEY

Yemenciler Inc
Mephisto Bookstores
Muge Deniz
T. +90 212 249 06 96
mugedeniz@mephisto.com.tr
www.mephisto.com.tr

URUGUAY

Mosca Hnos Sa
Elisa Fabricio
T. +598 2409 3141
elisa.fabricio@mosca.com.uy
www.mosca.com.uy

FOR OTHER COUNTRIES

Refer to Head Office

All of the brands, names and models of the devices are the property of the relative companies.

AirPods, AirPods Pro, iPad, iPhone, Lightning and Mac are trademarks of Apple Inc., registered in the U.S. and other countries.

The Bluetooth® trademark and related logos are registered trademarks owned by Bluetooth® SIG, Inc. Qi and the Qi symbol are registered trademarks of the Wireless Power Consortium.

All other brands, logos, product names and registered trademarks are the property of their respective owners.

We reserve the right to change any aspect of our programme without notice. This catalogue and the order form have been checked for accuracy. Please forgive us should any error occur nonetheless. We also accept no liability for potential errors. While we strive for utmost precision in every detail, we cannot be held responsible for any inaccuracies, nor for any subsequent loss or any damage arising from these. This catalogue is printed on environmentally safe, chlorine-free paper, unless limited by reasons of supply or production technicalities. Catalogue printed in Italy. All sizes are given in length x height x width. Our separate price list gives ordering details and terms and conditions of supply. The general terms and conditions of trade of Legami are in force.





LEGAMI SRL, VIA STEZZANO 18,
24052 AZZANO SAN PAOLO (BG) ITALY
PH + 39(0)35 534168 - FAX + 39(0)35 536973
WWW.LEGAMI.COM - INFO@LEGAMI.COM



SPRING/SUMMER 2021

